

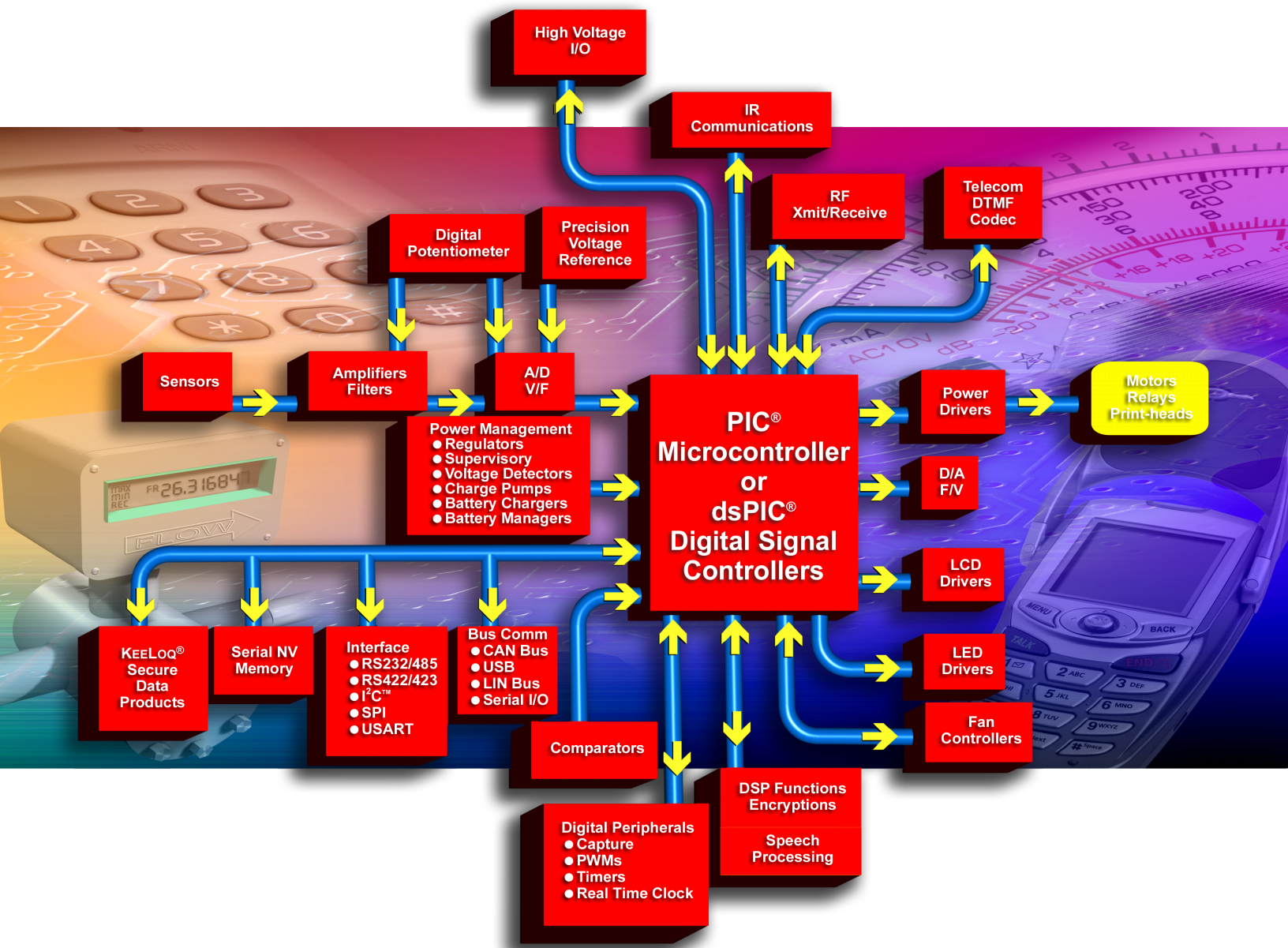

# 2006 Product Selector Guide



# Product Profile

## **8-bit PIC® Microcontrollers**

Microchip's PIC® family of microcontrollers combine high-performance, low cost and small package size to offer the best price/performance ratio in the industry. Based on a powerful RISC core, these 8-bit PIC® microcontrollers fall into three product architecture categories, providing a variety of options for any application requirement:

- **Baseline 8-bit architecture:** 12-bit instruction set, 6-44 pin count, 384-3.5 Kbytes program memory, up to 5 MIPS
- **Mid-Range 8-bit architecture:** 14-bit instruction set, 8-68 pin count, 896-14 Kbytes program memory, up to 5 MIPS
- **High-Performance (PIC18) 8-bit architecture:** 16-bit instruction set, 18-100 pin count, 8K-128 Kbytes program memory, up to 16 MIPS

The common architecture provides users with an easy migration path from 6 to 100 pins among all families with little or no code change required. Advanced features available are:

- Sophisticated timing peripherals
- Embedded analog peripherals including A/D and D/A converters, comparators, PBOR, PLVD, DAC, V<sub>REF</sub>, Op Amps and PSMC
- Communications peripherals (I<sup>2</sup>C™/SPI/USB/CAN and USARTs)
- Low-power, single-chip RF solutions targeting RF connectivity for high-volume embedded control applications
- Battery management solutions
- Flexible programming options including In-Circuit Serial Programming™ (ICSP™) technology, self-programming (Enhanced Flash), One-Time-Programmable (OTP), QTP, SQTP and ROM

## **16-bit PIC® Microcontrollers**

The PIC24 microcontrollers build upon the high performance, wide selection of peripherals, Flash memory sizes and packaging choices found in the 8-bit PIC18 family. The PIC24 architecture, paired with the optimized MPLAB® C30 C Compiler, provides the high throughput and C code density needed to achieve system performance goals and product launch schedules.

- Leadership 16-bit microcontroller performance and C code efficiency
- Extension of the 8-bit PIC18 microcontroller performance, memory and peripherals
- Easy migration path to dsPIC® digital signal controllers with over 40 MIPS, DSP capability and MPLAB® IDE compatibility

## **16-bit dsPIC® Digital Signal Controllers (DSC)**

Microchip's 16-bit high-performance digital signal controllers combine in a single core the best features of microcontrollers with the best features of DSPs. These dsPIC DSC devices reach speeds of up to 40 MIPS, are very efficient for C programming, and have Flash, data EEPROM, powerful peripherals and a variety of software libraries that allow high performance embedded solutions to be designed effortlessly and rapidly. With a familiar microcontroller "feel", tools and design environment, these dsPIC DSCs target applications, such as motor control and power conversion, speech and audio, internet and modem connectivity, telecom, encryption, high-speed sensing and automotive applications.

## **Stand-Alone Analog & Interface Products**

Microchip offers a broad portfolio of analog and related products:

- **Linear and Mixed-Signal.** ADCs/DACs, digital potentiometers, op amps and comparators.
- **Power Management.** LDO and switching regulators, charge pumps, voltage references, CPU/system supervisors and voltage detectors, battery chargers and power MOSFET drivers.
- **Thermal Management.** Temperature sensors (logic output, voltage output, and serial output), brushless DC fan controllers and fan fault detectors.
- **Interface.** Peripheral products supporting industry-standard networking protocols like CAN, LIN and infrared (including IrDA® Standard infrared), as well as products that provide embedded system input/output expansion capability.

## **Secure Data Products**

Microchip's KEELoq® code hopping algorithm combines high security, a small package outline and a very low cost to make this an ideal solution for unidirectional RKE systems. The KEELoq code hopping technology creates a high degree of security using a long code word length together with encryption and synchronization techniques.

## **Memory Products**

Microchip offers one of the broadest selections of serial EEPROMs in densities from 128 bits to 1 Mbit, with operating voltages down to 1.8V, in all popular bus protocols (I<sup>2</sup>C™, Microwire and SPI compatible). They are available in all standard temperature ranges from -40°C to +125°C, up to 16 Kbits in 5-lead SOT-23 and up to 256 Kbits in 8-lead MSOP

## **Development Systems**

Microchip offers a full range of microcontroller development systems, including the MPLAB® ICE 2000 and ICE 4000 in-circuit emulators; MPLAB Integrated Development Environment; MPLAB C18 and C30 Compiler; the MPLAB ICD In-Circuit Debugger, MPLAB PM3 full-featured device programmer; PICSTART® low-cost development system; the PICkit™ 2 Flash Starter Kit, SEEVAL® Serial EEPROM Evaluation Kit and various demonstration boards. Microchip has shipped more than 432,000 development systems worldwide.

# TABLE OF CONTENTS

<b>CURRENT 16-BIT CONTROLLER FAMILY PRODUCTS</b> .....	<b>6</b>
dsPIC® Digital Signal Controller (DSC) Family .....	6
dsPIC30F General Purpose Family: 30 MIPS .....	6
dsPIC30F Motor Control and Power Conversion Family: 30 MIPS .....	6
dsPIC30F Sensor Family: 30 MIPS .....	6
dsPIC33F General Purpose Family: 40 MIPS .....	7
dsPIC33F Motor Control Family: 40 MIPS .....	7
PIC24 16-Bit Microcontroller (MCU) Family .....	8
PIC24FJ Family 16-Bit Flash MCUs: 16 MIPS .....	8
PIC24HJ Family 16-Bit Flash MCUs: 40 MIPS .....	9
<b>FUTURE 16-BIT CONTROLLER FAMILY PRODUCTS</b> .....	<b>11</b>
dsPIC30F SMPS (Switched Mode Power Supplies and Other Applications): 30 MIPS .....	11
dsPIC33F General Purpose Family: 40 MIPS .....	11
dsPIC33F Motor Control Family: 40 MIPS .....	11
PIC24 16-Bit Microcontroller (MCU) Family .....	12
PIC24FJ Family 16-Bit Flash MCUs: 16 MIPS .....	12
PIC24HJ Family 16-Bit Flash MCUs: 40 MIPS .....	12
<b>CURRENT ANALOG/INTERFACE PRODUCTS</b> .....	<b>13</b>
THERMAL MANAGEMENT PRODUCTS – Temperature Sensors .....	13
Logic Output Temperature Sensors .....	13
Voltage Output Temperature Sensors .....	13
Serial Output Temperature Sensors .....	13
THERMAL MANAGEMENT PRODUCTS – Brushless DC Fan Controllers and Fan Fault Detectors .....	14
POWER MANAGEMENT – Voltage References .....	15
POWER MANAGEMENT – Linear Regulators .....	16
50 mA to 250 mA Low Dropout Linear Regulators .....	16
300 mA Low Dropout Linear Regulators .....	17
500 mA to 800 mA Low Dropout Linear Regulators .....	17
1A and Above Low Dropout Linear Regulators .....	17
Application Specific Low Dropout Linear Regulators .....	17
Power Management Combination Products .....	17
POWER MANAGEMENT – Switching Regulators .....	18
POWER MANAGEMENT – PWM Controllers .....	19
POWER MANAGEMENT – Charge Pump DC-to-DC Converters .....	19
Inverting or Doubling Charge Pumps .....	19
Multi-Function Charge Pumps .....	20
Inverting and Doubling Charge Pumps .....	20
Regulated Charge Pumps .....	20
POWER MANAGEMENT – CPU/System Supervisors .....	20

POWER MANAGEMENT – Voltage Detectors . . . . .	22
POWER MANAGEMENT – Power MOSFET Drivers . . . . .	22
Low-Side Drivers, 0.5A to 1.2A Peak Output Current . . . . .	22
Low-Side Drivers, 1.5A Peak Output Current . . . . .	22
Low-Side Drivers, 2.0A to 12.0A Peak Output Current . . . . .	23
High-Side/Low-Side Drivers . . . . .	23
POWER MANAGEMENT – Battery Chargers . . . . .	24
POWER MANAGEMENT – Hot Swap Controllers . . . . .	25
LINEAR – Op Amps . . . . .	25
LINEAR – High Precision Operational Amplifiers . . . . .	27
Chopper Stabilized . . . . .	27
Auto-Zero . . . . .	27
LINEAR – Programmable Gain Amplifiers (PGA) . . . . .	27
LINEAR – Integrated Devices . . . . .	28
LINEAR – Comparators . . . . .	28
MIXED SIGNAL – Successive Approximation Register (SAR) A/D Converters . . . . .	28
MIXED SIGNAL – Delta-Sigma A/D Converters . . . . .	29
MIXED SIGNAL – Energy Measurement ICs . . . . .	29
MIXED SIGNAL – Dual Slope A/D Converters . . . . .	30
MIXED SIGNAL – Binary and BCD A/D Converters . . . . .	30
MIXED SIGNAL – Display A/D Converters . . . . .	30
MIXED SIGNAL – Digital Potentiometers . . . . .	32
MIXED SIGNAL – Frequency-to-Voltage/Voltage-to-Frequency Converters . . . . .	32
MIXED SIGNAL – D/A Converters . . . . .	32
INTERFACE – Controller Area Network (CAN) Products . . . . .	33
INTERFACE – Infrared Products . . . . .	33
INTERFACE – Ethernet Products . . . . .	33
INTERFACE – LIN Transceiver Products . . . . .	34
INTERFACE – Serial Peripherals . . . . .	34
INTERFACE – Passive Access Products . . . . .	34
<b>FUTURE ANALOG/INTERFACE PRODUCTS . . . . .</b>	<b>35</b>
Power Management – Low-Side Power MOSFET Drivers . . . . .	35
Power Management – Battery Chargers . . . . .	35
Power Management – Linear Regulators . . . . .	35
Power Management – Switching Regulators . . . . .	35
Linear – Linear Gain Blocks . . . . .	35

<b>CURRENT 8-BIT PICmicro<sup>®</sup> MICROCONTROLLER FAMILY PRODUCTS</b>	<b>36</b>
Baseline 8-Bit PICmicro <sup>®</sup> Microcontroller Family (12-Bit Instruction Word)	36
PIC10FXXX	36
PIC12FXXX	36
PIC16F5XX	36
PIC16C5X	36
Mid-Range 8-Bit PICmicro <sup>®</sup> Microcontroller Family (14-Bit Instruction Word)	37
PIC12FXXX	37
PIC16FXXX	37
PIC16CXXX	39
High-Performance 8-Bit PICmicro <sup>®</sup> Microcontroller Family (16-Bit Instruction Word)	40
PIC18 Flash MCUs	40
PIC18FXXJXX Flash MCUs	45
<b>FUTURE PICmicro<sup>®</sup> MICROCONTROLLER FAMILY PRODUCTS</b>	<b>47</b>
Mid-Range 8-Bit PICmicro <sup>®</sup> Microcontroller Family (14-Bit Instruction Word)	47
PIC12FXXX	47
PIC16FXXX	47
PIC16CRXX	47
High-Performance 8-Bit PICmicro <sup>®</sup> Microcontroller Family (16-Bit Instruction Word)	48
PIC18FXXX	48
PIC18FXXJXX	48
PIC18FXXKXX	49
<b>MATURE – PICmicro<sup>®</sup> MCU AND dsPIC<sup>®</sup> DSC FAMILY PRODUCTS</b>	<b>50</b>
<b>FOCUSED SOLUTIONS</b>	<b>52</b>
CAN Solutions ( <a href="http://www.microchip.com/can">www.microchip.com/can</a> )	52
CAN Peripherals/Transceivers	54
Ethernet Solutions ( <a href="http://www.microchip.com/ethernet">www.microchip.com/ethernet</a> )	55
Ethernet Solutions – Integrated	55
Ethernet Solutions – Stand-Alone	55
USB Solutions ( <a href="http://www.microchip.com/usb">www.microchip.com/usb</a> )	56
USB Battery Chargers	57
Radio Frequency Solutions ( <a href="http://www.microchip.com/rf">www.microchip.com/rf</a> )	57
rfPIC <sup>®</sup> Microcontrollers with UHF RF Transmitter, ICSP <sup>™</sup>	57
rfHCS KEELOQ <sup>®</sup> Encoders with UHF RF Transmitter	57
UHF RF Receiver	57
microID <sup>®</sup> RFID Tagging Devices	57
LCD Solutions ( <a href="http://www.microchip.com/lcd">www.microchip.com/lcd</a> )	58
Display Solutions	59
Motor Control Solutions - MOSFET Drivers	60
Motor Control Solutions - LINEAR – Comparators	60
Motor Control Solutions - LINEAR – Op Amps	61
Motor Control Solutions - LINEAR – High Precision Operational Amplifiers	63

Intelligent Sensing Solutions . . . . .	63
Power-Managed Solutions Featuring nanoWatt Technology . . . . .	64
Motor Control Solutions . . . . .	65
<b>CURRENT SECURE DATA PRODUCTS . . . . .</b>	<b>66</b>
KEELOQ® Encoder Devices . . . . .	66
KEELOQ® Decoder Devices . . . . .	66
KEELOQ® Programmable Encoder/Decoder Flash Devices (x14), ICSP™ . . . . .	66
<b>CURRENT SERIAL ELECTRICALLY ERASABLE PROMS (EEPROM) . . . . .</b>	<b>67</b>
Microwire Compatible Serial EEPROM Family . . . . .	67
2-Wire I <sup>2</sup> C™ Compatible Serial EEPROM Family . . . . .	68
ISO Smart Card Family . . . . .	69
SPI Compatible Serial EEPROM Family . . . . .	69
Identification Products . . . . .	70
<b>FUTURE SERIAL ELECTRICALLY ERASABLE PROMS (EEPROM) . . . . .</b>	<b>71</b>
SPI Compatible Serial EEPROM Family . . . . .	71
<b>DEVELOPMENT SYSTEMS . . . . .</b>	<b>72</b>
MPLAB® ICE 2000 and MPLAB® ICE 4000 Emulator Systems . . . . .	72
MPLAB® PM3 Programmers . . . . .	72
In-Circuit Debuggers: MPLAB® ICD 2 . . . . .	72
MPLAB® ICE 2000 and MPLAB® ICE 4000 Emulator Systems, PRO MATE® II Programmer Socket Modules, MPLAB® In-Circuit Debugger, Software Tools, Programmers and Demonstration Boards . . . . .	73
Analog Interface Development Tools . . . . .	73
PICmicro® Microcontroller Development Tools . . . . .	73
rPIC® Microcontroller Development Tools . . . . .	104
dsPIC® DSC Development Tools . . . . .	105
Demonstration Boards and Evaluation Kits . . . . .	109
PICmicro® Demonstration Kits . . . . .	109
Connectivity Demonstration Kits . . . . .	109
Mixed Signal Control Demonstration Kits . . . . .	110
dsPIC® DSC Demonstration Kits . . . . .	110
dsPIC® 16-Bit DSC Software Tools . . . . .	110
Memory Evaluation/Developer's Kits . . . . .	111
KEELOQ® Evaluation Kits . . . . .	111
RFID Evaluation/Developer's Kits . . . . .	111
Analog/Interface Demo/Eval/Developer's Kits . . . . .	111
<b>PIN AND CODE COMPATIBILITY CHART . . . . .</b>	<b>113</b>
<b>PACKAGE PHOTOS . . . . .</b>	<b>118</b>

**PART NUMBER SUFFIX DESIGNATIONS** ..... 121

Ordering Information for all Microchip PICmicro<sup>®</sup>, dsPIC<sup>®</sup>, KEELOQ<sup>®</sup>, RFID, rfHCS and  
Memory Products .....121

Ordering Information for all Microchip Analog Products beginning with “TC” (formerly TelCom  
Semiconductor Products).....122

Ordering Information for all Microchip Analog Products beginning with “MCP” Prefix Parts .....123

**BASE QUANTITIES** ..... 124

**ABBREVIATIONS**..... 125

# CURRENT 16-BIT CONTROLLER FAMILY PRODUCTS

Product	Program Memory (Kbytes)	Self-Write	Data EEPROM (Bytes)	RAM (Bytes)	I/O Pins	Packages	A/D 12-Bit 200 kbps	A/D 10-Bit 1 Msps	Timer 16-Bit	Input Cap	Output Comp/Std PWM	Motor Control PWM	QEI	UART	SPI	I <sup>2</sup> C™	CAN	Codec Interface	
dsPIC30F3014	24	✓	1024	2048	30	40P, 44PT, 44ML (8x8)	13 ch	—	3	2	2	—	—	2	1	1	—	—	
dsPIC30F4013	48	✓	1024	2048	30	40P, 44PT, 44ML (8x8)	13 ch	—	5	4	4	—	—	2	1	1	1	AC97, I <sup>2</sup> S	
dsPIC30F5011	66	✓	1024	4096	52	64PT	16 ch	—	5	8	8	—	—	2	2	1	2	AC97, I <sup>2</sup> S	
dsPIC30F5013	66	✓	1024	4096	68	80PT	16 ch	—	5	8	8	—	—	2	2	1	2	AC97, I <sup>2</sup> S	
dsPIC30F6011A	132	✓	2048	6144	52	64PF, 64PT	16 ch	—	5	8	8	—	—	2	2	1	2	—	
dsPIC30F6012A	144	✓	4096	8192	52	64PF, 64PT	16 ch	—	5	8	8	—	—	2	2	1	2	AC97, I <sup>2</sup> S	
dsPIC30F6013A	132	✓	2048	6144	68	80PF, 80PT	16 ch	—	5	8	8	—	—	2	2	1	2	—	
dsPIC30F6014A	144	✓	4096	8192	68	80PF, 80PT	16 ch	—	5	8	8	—	—	2	2	1	2	AC97, I <sup>2</sup> S	
-----																			
dsPIC30F2010	12	✓	1024	512	20	28SO, 28SP, 28MM (6x6)	—	6 ch	3	4	2	6	✓	1	1	1	—	—	
dsPIC30F3010	24	✓	1024	1024	20	28SO, 28SP, 44ML (8x8)	—	6 ch	5	4	2	6	✓	1	1	1	—	—	
dsPIC30F4012	48	✓	1024	2048	20	28SO, 28SP, 44ML (8x8)	—	6 ch	5	4	2	6	✓	1	1	1	1	—	
dsPIC30F3011	24	✓	1024	1024	30	40P, 44PT, 44ML (8x8)	—	9 ch	5	4	4	6	✓	2	1	1	—	—	
dsPIC30F4011	48	✓	1024	2048	30	40P, 44PT, 44ML (8x8)	—	9 ch	5	4	4	6	✓	2	1	1	1	—	
dsPIC30F5015	66	✓	1024	2048	52	64PT	—	16 ch	5	4	4	8	✓	1	2	1	1	—	
dsPIC30F6015	144	✓	4096	8192	52	64PT	—	16 ch	5	8	8	8	✓	2	2	1	1	—	
dsPIC30F5016	66	✓	1024	2048	68	80PT	—	16 ch	5	4	4	8	✓	1	2	1	1	—	
dsPIC30F6010A	144	✓	4096	8192	68	80PF, 80PT	—	16 ch	5	8	8	8	✓	2	2	1	2	—	
-----																			
dsPIC30F2011	12	✓	0	1024	12	18SO, 18P, 28ML (6x6)	8 ch	—	3	2	2	—	—	1	1	1	—	—	
dsPIC30F3012	24	✓	1024	2048	12	18SO, 18P, 44ML (8x8)	8 ch	—	3	2	2	—	—	1	1	1	—	—	
dsPIC30F2012	12	✓	0	1024	20	28SO, 28SP, 28ML (6x6)	10 ch	—	3	2	2	—	—	1	1	1	—	—	
dsPIC30F3013	24	✓	1024	2048	20	28SO, 28SP, 44ML (8x8)	10 ch	—	3	2	2	—	—	2	1	1	—	—	

Abbreviations are found on the last page of the Selector Guide.

**NEW**

**NEW**



**dsPIC® Digital Signal Controller (DSC) Family (continued)**

Product	Program Memory (Kbytes)	Self-Write	RAM (Kbytes)	DMA	I/O Pins	Packages	A/D Config. as 10-Bit @ 1.1 Msps or 12-Bit @ 500 ksp/s(1,2)	Timer 16-Bit	Input Cap	Output Comp/Std PWM	Motor Control PWM	QEI	UART	SPI	i <sup>2</sup> C™	ECAN™ Technology	Codec Interface
<b>dsPIC33F General Purpose Family: 40 MIPS, V<sub>DD</sub> = 3.0V-3.6V</b>																	
<b>NEW</b>		✓	8	8 ch	53	64PT	1 A/D, 18 ch, 4 S/H max	9	8	8	—	—	2	2	1	0	1
<b>NEW</b>		✓	16	8 ch	85	100PT, 100PF	1 A/D, 32 ch, 4 S/H max	9	8	8	—	—	2	2	2	0	1
<b>NEW</b>		✓	16	8 ch	53	64PT	2 A/D, 18 ch, 8 S/H max	9	8	8	—	—	2	2	2	2	1
<b>NEW</b>		✓	16	8 ch	69	80PT	2 A/D, 24 ch, 8 S/H max	9	8	8	—	—	2	2	2	2	1
<b>NEW</b>		✓	16	8 ch	85	100PT, 100PF	2 A/D, 32 ch, 8 S/H max	9	8	8	—	—	2	2	2	2	1
<b>NEW</b>		✓	16	8 ch	53	64PT	2 A/D, 18 ch, 8 S/H max	9	8	8	—	—	2	2	2	2	1
<b>NEW</b>		✓	16	8 ch	69	80PT	2 A/D, 24 ch, 8 S/H max	9	8	8	—	—	2	2	2	2	1
<b>NEW</b>		✓	16	8 ch	85	100PT, 100PF	2 A/C, 32 ch, 8 S/H max	9	8	8	—	—	2	2	2	2	1
<b>NEW</b>		✓	16	8 ch	53	64PT	1 A/D, 18 ch, 4 S/H max	9	8	8	—	—	2	2	2	1	1
<b>NEW</b>		✓	30	8 ch	85	100PT, 100PF	2 A/D, 32 ch, 8 S/H max	9	8	8	—	—	2	2	2	2	1
<b>dsPIC33F Motor Control Family: 40 MIPS, V<sub>DD</sub> = 3.0V-3.6V</b>																	
<b>NEW</b>		✓	8	8 ch	53	64PT	1 A/D, 16 ch, 4 S/H max	9	8	8	8	✓	2	2	2	1	—
<b>NEW</b>		✓	8	8 ch	69	80PT	1 A/D, 18 ch, 4 S/H max	9	8	8	8	✓	2	2	2	1	—
<b>NEW</b>		✓	8	8 ch	85	100PT, 100PF	1 A/D, 24 ch, 4 S/H max	9	8	8	8	✓	2	2	2	1	—

**NOTE 1:** dsPIC33F devices with 2 A/D converters can achieve 2.2 Msps conversion rate.  
**2:** Each A/D configured as 10-bit has 4 S/H. Each A/D configured as 12-bit has 1 S/H.  
 \*Contact Microchip Technology for availability date.  
 Abbreviations are found on the last page of the Selector Guide.

# Controller Family

## dsPIC® Digital Signal Controller (DSC) Family (continued)

Product	Program Memory (Kbytes)	Self-Write (Kbytes)	RAM (Kbytes)	DMA	I/O Pins	Packages	A/D Config. as 10-Bit @ 1.1 Msps or 12-Bit @ 500 ksp/s <sup>(1,2)</sup>	Timer 16-Bit	Input Cap	Output Comp/Std PWM	Motor Control PWM	QEI	UART	SPI	I <sup>2</sup> C™	ECAN™ Technology	Codec Interface
<b>dsPIC33F Motor Control Family: 40 MIPS, VDD = 3.0V-3.6V (continued)</b>																	
dsPIC33FJ64MC706	64	✓	16	8 ch	53	64PT	2 A/D, 16 ch, 8 S/H max	9	8	8	8	✓	2	2	2	1	—
dsPIC33FJ64MC710	64	✓	16	8 ch	85	100PT, 100PF	2 A/D, 24 ch, 8 S/H max	9	8	8	8	✓	2	2	2	2	—
dsPIC33FJ128MC506*	128	✓	8	8 ch	53	64PT	1 A/D, 16 ch, 4 S/H max	9	8	8	8	✓	2	2	2	1	—
dsPIC33FJ128MC706	128	✓	16	8 ch	53	64PT	2 A/D, 16 ch, 8 S/H max	9	8	8	8	✓	2	2	2	1	—
dsPIC33FJ128MC708	128	✓	16	8 ch	69	80PT	2 A/D, 18 ch, 8 S/H max	9	8	8	8	✓	2	2	2	1	—
dsPIC33FJ128MC710*	128	✓	16	8 ch	85	100PT, 100PF	2 A/D, 24 ch, 8 S/H max	9	8	8	8	✓	2	2	2	2	—
dsPIC33FJ256MC710	256	✓	30	8 ch	85	100PT, 100PF	2 A/D, 24 ch, 8 S/H max	9	8	8	8	✓	2	2	2	2	—

**NOTE 1:** dsPIC33F devices with 2 A/D converters can achieve 2.2 Msps conversion rate.

**2:** Each A/D configured as 10-bit has 4 S/H. Each A/D configured as 12-bit has 1 S/H.

\*Contact Microchip Technology for availability date.

Abbreviations are found on the last page of the Selector Guide.

## PIC24 16-Bit Microcontroller (MCU) Family

Product	Program Memory (Kbytes/ K words)	Self-Write (Kbytes)	RAM (Kbytes)	I/O Pins	Packages	Analog		Digital							IntOSC	PMP	nW	Other Features	
						ADC	Comp.	Timers 16-Bit	Input Cap	Output Comp/PWM	RTCC	UART w/IrDA®	SPI	I <sup>2</sup> C™					ECAN™ Technology
<b>PIC24FJ Family 16-Bit Flash MCUs: 16 MIPS, VDD = 2.0V-3.6V</b>																			
PIC24FJ64GA006	64	✓	8	53	64PT	16x10-bit 500 ksp/s	2	5	5	5	✓	2	2	2	—	✓	8 MHz 32 KHz	✓	JTAG
PIC24FJ64GA008	64	✓	8	69	80PT	16x10-bit 500 ksp/s	2	5	5	5	✓	2	2	2	—	✓	8 MHz 32 KHz	✓	JTAG
PIC24FJ64GA010	64	✓	8	85	100PT, 100PF	16x10-bit 500 ksp/s	2	5	5	5	✓	2	2	2	—	✓	8 MHz 32 KHz	✓	JTAG

**NOTE:** PIC24H devices with 2 A/D converters can achieve 2.2 Msps conversion rate.

\*Contact Microchip Technology for availability date.

Abbreviations are found on the last page of the Selector Guide.

**PIC24 16-Bit Microcontroller (MCU) Family (continued)**

Product	Program Memory (Kbytes/ K words)	Self-Write	RAM (Kbytes)	I/O Pins	Packages	Analog		Digital							IntOSC	PMP	nW	Other Features	
						ADC	Comp.	Timers 16-Bit	Input Cap	Output Comp/PWM	RTCC	UART w/IrDA®	SPI	I <sup>2</sup> C™					ECAN™ Technology
<b>PIC24FJ Family 16-Bit Flash MCUs: 16 MIPS, V<sub>DD</sub> = 2.0V-3.6V (continued)</b>																			
<b>NEW</b>	PIC24FJ96GA006	96	✓	8	53	64PT	16x10-bit 500 kspcs	2	5	5	5	✓	2	2	2	8 MHz 32 KHz	✓	✓	JTAG
<b>NEW</b>	PIC24FJ96GA008	96	✓	8	69	80PT	16x10-bit 500 kspcs	2	5	5	5	✓	2	2	2	8 MHz 32 KHz	✓	✓	JTAG
<b>NEW</b>	PIC24FJ96GA010	96	✓	8	85	100PT, 100PF	16x10-bit 500 kspcs	2	5	5	5	✓	2	2	2	8 MHz 32 KHz	✓	✓	JTAG
<b>NEW</b>	PIC24FJ128GA006	128	✓	8	53	64PT	16x10-bit 500 kspcs	2	5	5	5	✓	2	2	2	8 MHz 32 KHz	✓	✓	JTAG
<b>NEW</b>	PIC24FJ128GA008	128	✓	8	69	80PT	16x10-bit 500 kspcs	2	5	5	5	✓	2	2	2	8 MHz 32 KHz	✓	✓	JTAG
<b>NEW</b>	PIC24FJ128GA010	128	✓	8	85	100PT, 100PF	16x10-bit 500 kspcs	2	5	5	5	✓	2	2	2	8 MHz 32 KHz	✓	✓	JTAG
<b>PIC24HJ Family 16-Bit Flash MCUs: 40 MIPS, V<sub>DD</sub> = 3.0V-3.6V</b>																			
<b>NEW</b>	PIC24HJ64GP206	64	✓	8	53	64PT	18x10-bit 1.1 Msps or 12-bit 500 kspcs	—	9	8	8	—	2	2	1	8 MHz 32 KHz	—	✓	JTAG, DMA (8 ch)
<b>NEW</b>	PIC24HJ64GP210	64	✓	8	85	100PT, 100PF	32x10-bit 1.1 Msps or 12-bit 500 kspcs	—	9	8	8	—	2	2	2	8 MHz 32 KHz	—	✓	JTAG, DMA (8 ch)
<b>NEW</b>	PIC24HJ64GP506*	64	✓	8	53	64PT	18x10-bit 1.1 Msps or 12-bit 500 kspcs	—	9	8	8	—	2	2	2	8 MHz 32 KHz	—	✓	JTAG, DMA (8 ch)
<b>NEW</b>	PIC24HJ64GP510*	64	✓	8	85	100PT, 100PF	32x10-bit 1.1 Msps or 12-bit 500 kspcs	—	9	8	8	—	2	2	2	8 MHz 32 KHz	—	✓	JTAG, DMA (8 ch)

**NOTE:** PIC24H devices with 2 A/D converters can achieve 2.2 Msps conversion rate.  
\*Contact Microchip Technology for availability date.  
Abbreviations are found on the last page of the Selector Guide.

**PIC24 16-Bit Microcontroller (MCU) Family (continued)**

Product	Program Memory (Kbytes/ K words)	Self-Write	RAM (Kbytes)	I/O Pins	Packages	Analog		Digital							IntOSC	PMP	nW	Other Features		
						ADC	Comp.	Timers 16-Bit	Input Cap	Output Comp/PWM	RTCC	UART w/IrDA®	SPI	I <sup>2</sup> C™					ECAN™ Technology	
<b>PIC24HJ Family 16-Bit Flash MCUs: 40 MIPS, V<sub>DD</sub> = 3.0V-3.6V (continued)</b>																				
<b>NEW</b>	PIC24HJ128GP206	128	✓	8	53	64PT	18x10-bit 1.1 Msps or 12-bit 500 ksps	—	9	8	8	—	2	2	2	—	8 MHz 32 kHz	—	✓	JTAG, DMA (8 ch)
<b>NEW</b>	PIC24HJ128GP306*	128	✓	16	53	64PT	18x10-bit 1.1 Msps or 12-bit 500 ksps	—	9	8	8	—	2	2	2	—	8 MHz 32 kHz	—	✓	JTAG, DMA (8 ch)
<b>NEW</b>	PIC24HJ128GP310*	128	✓	16	85	100PT, 100PF	32x10-bit 1.1 Msps or 12-bit 500 ksps	—	9	8	8	—	2	2	2	—	8 MHz 32 kHz	—	✓	JTAG, DMA (8 ch)
<b>NEW</b>	PIC24HJ128GP506	128	✓	8	53	64PT	18x10-bit 1.1 Msps or 12-bit 500 ksps	—	9	8	8	—	2	2	2	1	8 MHz 32 kHz	—	✓	JTAG, DMA (8 ch)
<b>NEW</b>	PIC24HJ256GP206	256	✓	16	53	64PT	18x10-bit 1.1 Msps or 12-bit 500 ksps	—	9	8	8	—	2	2	2	—	8 MHz 32 kHz	—	✓	JTAG, DMA (8 ch)
<b>NEW</b>	PIC24HJ256GP610	256	✓	16	85	100PT, 100PF	(2) 32x10-bit 1.1 Msps or 12-bit 500 ksps	—	9	8	8	—	2	2	2	2	8 MHz 32 kHz	—	✓	JTAG, DMA (8 ch)

**NOTE:** PIC24H devices with 2 A/D converters can achieve 2.2 Msps conversion rate.  
\*Contact Microchip Technology for availability date.  
Abbreviations are found on the last page of the Selector Guide.

# FUTURE 16-BIT CONTROLLER FAMILY PRODUCTS

Product	Program Memory (Kbytes)	Self-Write	RAM (Bytes)	Packages	A/D 10-Bit 2 Msps	# of S/H	High-Speed SMI <sup>PS</sup> PWM (10-Bit @ 937 kHz)	High-Speed Analog Comp.	Timer 16-Bit	Input Cap	Output Comp/Std PWM	UART	SPI	i <sup>2</sup> C™
<b>dsPIC30F SMI<sup>PS</sup> (Switched Mode power Supplies and Other Applications): 30 MIPS, V<sub>DD</sub> = 2.5V-5.5V</b>														
dsPIC30F1010	6	✓	256	28SP, 28SO, 28MM	8 ch	2	2 x 2	2	2	—	1	1	1	1
dsPIC30F2020	12	✓	512	28SP, 28SO, 28MM	8 ch	4	4 x 2	4	3	1	2	1	1	1
dsPIC30F2023	12	✓	512	44PT, 44ML	12 ch	4	4 x 2	4	3	1	2	1	1	1

Abbreviations are found on the last page of the Selector Guide.

Product	Program Memory (Kbytes)	Self-Write	RAM (Kbytes)	DMA	I/O Pins	Packages	A/D Config, as 10-Bit @ 1.1 Msps or 12-bit @ 500 ksps	Timer 16-Bit	Input Cap	Output Comp/Std PWM	Motor Control PWM	QEI	UART	SPI	i <sup>2</sup> C™	ECAN™ Technology	Codec Interface
<b>dsPIC33F General Purpose Family: 40 MIPS, V<sub>DD</sub> = 3.0V-3.6V</b>																	
dsPIC33FJ12GP201	12	✓	1	—	13	18P, 18SO, 20SS	1 A/D, 10 ch, 4 S/H max	3	4	2	—	—	1	1	1	—	—
dsPIC33FJ12GP202	12	✓	1	—	21	28SP, 28SO, 28SS, 28ML	1 A/D, 10 ch, 4 S/H max	3	4	2	—	—	1	1	1	—	—
dsPIC33FJ64GP306	64	✓	16	8 ch	53	64PT	1 A/D, 18 ch, 4 S/H max	9	8	8	—	—	2	2	2	—	1
dsPIC33FJ128GP206	128	✓	8	8 ch	53	64PT	1 A/D, 18 ch, 4 S/H max	9	8	8	—	—	2	2	1	—	1
dsPIC33FJ128GP306	128	✓	16	8 ch	53	64PT	1 A/D, 18 ch, 4 S/H max	9	8	8	—	—	2	2	2	—	1
dsPIC33FJ128GP310	128	✓	16	8 ch	85	100PT, 100PF	1 A/D, 32 ch, 4 S/H max	9	8	8	—	—	2	2	2	—	1
dsPIC33FJ256GP510	256	✓	16	8 ch	85	100PT, 100PF	1 A/D, 32 ch, 4 S/H max	9	8	8	—	—	2	2	2	1	1

**dsPIC33F Motor Control Family: 40 MIPS, V<sub>DD</sub> = 3.0V-3.6V**

dsPIC33FJ12MC201	12	✓	1	—	15	20SP, 20SO, 20SS	1 A/D, 10 ch, 4 S/H max	3	4	2	6	1	1	1	1	—	—
dsPIC33FJ12MC202	12	✓	1	—	21	28SP, 28SO, 28SS, 28ML	1 A/D, 10 ch, 4 S/H max	3	4	2	6	1	1	1	1	—	—
dsPIC33FJ128MC510	128	✓	8	8 ch	85	100PT, 100PF	1 A/D, 24 ch, 4 S/H max	9	8	8	8	✓	2	2	2	1	—
dsPIC33FJ256MC510	256	✓	16	8 ch	85	100PT, 100PF	1 A/D, 16 ch, 4 S/H max	9	8	8	8	✓	2	2	2	1	—

NOTE 1: dsPIC33F devices with 2 A/D converters can achieve 2.2 Msps conversion rate.  
 2: Each A/D configured as 10-bit has 4 S/H. Each A/D configured as 12-bit has 1 S/H.  
 Abbreviations are found on the last page of the Selector Guide.

**PIC24 16-Bit Microcontroller (MCU) Family**

Product	Program Memory (Kbytes)	Self-Write (Kbytes)	RAM (Kbytes)	I/O Pins	Packages	Analog		Digital							IntOSC	PMP	nW	Other Features	
						ADC	Comp.	Timers 16-Bit	Input Cap	Output Comp/PWM	RTCC	UART w/IrDA®	SPI	I <sup>2</sup> C™					Peripheral-to-Pin Map
<b>PIC24FJ Family 16-Bit Flash MCUs: 16 MIPS, V<sub>DD</sub> = 2.0V-3.6V</b>																			
PIC24FJ32GA002	32	✓	8	21	28SP, 28SO, 28ML	10x10-bit 500 ksps	2	5	5	5	✓	2	2	2	2	8 MHz 32 kHz	✓	✓	JTAG
PIC24FJ64GA002	64	✓	8	21	28SP, 28SO, 28ML	10x10-bit 500 ksps	2	5	5	5	✓	2	2	2	2	8 MHz 32 kHz	✓	✓	JTAG
PIC24FJ32GA004	32	✓	8	35	44ML, 44PT	13x10-bit 500 ksps	2	5	5	5	✓	2	2	2	2	8 MHz 32 kHz	✓	✓	JTAG
PIC24FJ64GA004	64	✓	8	35	44ML, 44PT	13x10-bit 500 ksps	2	5	5	5	✓	2	2	2	2	8 MHz 32 kHz	✓	✓	JTAG
<b>PIC24HJ Family 16-Bit Flash MCUs: 40 MIPS, V<sub>DD</sub> = 3.0V-3.6V</b>																			
PIC24HJ12GP201	12	✓	1	13	18P, 18SO, 20SS	10x10-bit 1.1 Msps or 12-bit 500 ksps	—	3	4	2	—	1	1	1	1	8 MHz 32 kHz	—	✓	
PIC24HJ12GP202	12	✓	1	21	28SP, 28SO, 28SS, 28ML	10x10-bit 1.1 Msps or 12-bit 500 ksps	—	3	4	2	—	1	1	1	1	8 MHz 32 kHz	—	✓	JTAG
PIC24HJ128GP210	128	✓	8	85	100PT, 100PF	32x10-bit 1.1 Msps or 12-bit 500 ksps	—	9	8	8	—	2	2	2	2	8 MHz 32 kHz	—	✓	JTAG, DMA (8 ch)
PIC24HJ128GP510	128	✓	8	85	100PT, 100PF	32x10-bit 1.1 Msps or 12-bit 500 ksps	—	9	8	8	—	2	2	2	2	8 MHz 32 kHz	—	✓	JTAG, DMA (8 ch)
PIC24HJ256GP210	256	✓	18	85	100PT, 100PF	32x10-bit 1.1 Msps or 12-bit 500 ksps	—	9	8	8	—	2	2	2	2	8 MHz 32 kHz	—	✓	JTAG, DMA (8 ch)

Abbreviations are found on the last page of the Selector Guide.

## CURRENT ANALOG/INTERFACE PRODUCTS

Lead-free versions of many devices are currently offered. Check Microchip's web site for availability.

THERMAL MANAGEMENT PRODUCTS – Temperature Sensors							
Part #	Typical Accuracy (°C)	Maximum Accuracy @ 25°C (°C)	Maximum Temperature Range (°C)	Vcc Range (V)	Maximum Supply Current (µA)	Features	Packages
<b>Logic Output Temperature Sensors</b>							
TC6501	±0.5	±3	-55 to +125	+2.7 to +5.5	40	Cross to MAX6501, Open-drain	5-Pin SOT-23A
TC6502	±0.5	±3	-55 to +125	+2.7 to +5.5	40	Cross to MAX6502, Push-pull	5-Pin SOT-23A
TC6503	±0.5	±3	-55 to +125	+2.7 to +5.5	40	Cross to MAX6503, Open-drain	5-Pin SOT-23A
TC6504	±0.5	±3	-55 to +125	+2.7 to +5.5	40	Cross to MAX6504, Push-pull	5-Pin SOT-23A
TC620	±1	±3	-40 to +125	+4.5 to +18	400	Two resistor-programmable trip points	8-Pin PDIP, 8-Pin SOIC
TC621	Note 1	Note 1	-40 to +85	+4.5 to +18	400	Requires external thermistor, resistor-programmable trip points	8-Pin PDIP, 8-Pin SOIC
TC622	±1	±5	-40 to +125	+4.5 to +18	600	Dual output, TO-220 for heat sink mounting, resistor-programmable trip points	8-Pin PDIP, 8-Pin SOIC, 5-Pin TO-220
TC623	±1	±3	-40 to +125	+2.7 to +4.5	250	Two resistor-programmable trip points	8-Pin PDIP, 8-Pin SOIC
TC624	±1	±5	-40 to +125	+2.7 to +4.5	300	Dual output, resistor-programmable trip points	8-Pin PDIP, 8-Pin SOIC
<b>Voltage Output Temperature Sensors</b>							
MCP9700	±1	±4	-40 to +125	+2.3 to +5.5	12	Linear Active Thermistor™ IC, Temperature slope: 10 mV/°C	3-pin TO-92, 5-pin SC-70
MCP9701	±1	±4	-10 to +125	+3.1 to +5.5	12	Linear Active Thermistor™ IC, Temperature slope: 19.53 mV/°C, cross to MAX6612	3-pin TO-92, 5-pin SC-70
MCP9700A	±1	±2	-40 to +125	+2.3 to +5.5	12	Linear Active Thermistor™ IC, Temperature slope: 10 mV/°C	3-pin TO-92, 5-pin SC-70
MCP9701A	±1	±2	-40 to +125	+3.1 to +5.5	12	Linear Active Thermistor™ IC, Temperature slope: 19.53 mV/°C, cross to MAX6612	3-pin TO-92, 5-pin SC-70
TC1046	±0.5	±2	-40 to +125	+2.7 to +4.4	60	High precision temperature-to-voltage converter, 6.25 mV/°C	3-Pin SOT-23B
TC1047	±0.5	±2	-40 to +125	+2.7 to +4.4	60	High precision temperature-to-voltage converter, 10 mV/°C	3-Pin SOT-23B
TC1047A	±0.5	±2	-40 to +125	+2.5 to +5.5	60	High precision temperature-to-voltage converter, 10 mV/°C	3-Pin SOT-23B
<b>Serial Output Temperature Sensors</b>							
MCP9800	±0.5	±1	-55 to +125	+2.7 to +5.5	400	SMBus/I <sup>2</sup> C™ compatible interface, 0.0625°C to 0.5°C adj. resolution, power-saving one-shot temperature measurement	5-Pin SOT-23
MCP9801	±0.5	±1	-55 to +125	+2.7 to +5.5	400	SMBus/I <sup>2</sup> C™ compatible interface, 0.0625°C to 0.5°C adj. resolution, power-saving one-shot temperature measurement, multi-drop capability	8-Pin MSOP, 8-pin SOIC

**NOTE** 1: These devices use an external temperature sensor. Accuracy of the total solution is a function of the accuracy of the external sensor.  
 2: TCN75 idle current is 250 µA. This device also has a Software Shutdown mode that reduces supply current to <1 µA.  
 3: MCP9805 max. accuracy measured at 85°C.

**THERMAL MANAGEMENT PRODUCTS – Temperature Sensors (continued)**

Part #	Typical Accuracy (°C)	Maximum Accuracy @ 25°C (°C)	Maximum Temperature Range (°C)	Vcc Range (V)	Maximum Supply Current (µA)	Features	Packages
<b>Serial Output Temperature Sensors (continued)</b>							
MCP9802	±0.5	±1	-55 to +125	+2.7 to +5.5	400	SMBus/I <sup>2</sup> C™ compatible interface with time out, 0.0625°C to 0.5°C adj. resolution, power-saving one-shot temperature measurement	5-Pin SOT-23
MCP9803	±0.5	±1	-55 to +125	+2.7 to +5.5	400	SMBus/I <sup>2</sup> C™ compatible interface with time out, 0.0625°C to 0.5°C adj. resolution, power-saving one-shot temperature measurement, multi-drop capability	8-Pin MSOP, 8-Pin SOIC
MCP9805	±0.5	±1(3)	-20 to +125	+3.0 to +3.6	400	JEDEC compatible register set, SMBus/I <sup>2</sup> C™ compatible interface, programmable, shut-down modes and EVENT output	8-Pin TSSOP, 8-Pin 2x3 DFN
TC77	±0.5	±1	-55 to +125	+2.7 to +5.5	400	SPI compatible interface, 0.0625°C temperature resolution	5-Pin SOT-23A, 8-Pin SOIC
TC72	±0.5	±1	-55 to +125	+2.65 to +5.5	400	SPI compatible interface, power saving one-shot temperature measurement, 0.25°C temperature resolution	8-Pin MSOP, 8-Pin 3x3 DFN
TC74	±0.5	±2	-40 to +125	+2.7 to +5.5	350	SMBus/I <sup>2</sup> C™ compatible interface, 1°C temperature resolution	5-Pin SOT-23A, 5-Pin TO-220
TCN75A	±0.5	±2	-40 to +125	+2.7 to +5.5	500	SMBus/I <sup>2</sup> C™ compatible interface, power-saving one-shot temperature measurement, multi-drop capability, 0.0625°C to 0.5°C adjustable temperature resolution	8-Pin SOIC, 8-Pin MSOP
TCN75	±0.5	±2	-55 to +125	+2.7 to +5.5	1,000(2)	SMBus/I <sup>2</sup> C™ compatible interface, multi-drop capability, interrupt output, 0.5°C temperature resolution	8-Pin MSOP, 8-Pin SOIC

**NOTE 1:** These devices use an external temperature sensor. Accuracy of the total solution is a function of the accuracy of the external sensor.

**2:** TCN75 idle current is 250 µA. This device also has a Software Shutdown mode that reduces supply current to <1 µA.

**3:** MCP9805 max. accuracy measured at 85°C.

**THERMAL MANAGEMENT PRODUCTS – Brushless DC Fan Controllers and Fan Fault Detectors**

Part #	Description	Typical Accuracy (°C)	Maximum Accuracy @ 25°C (°C)	Maximum Temperature Range (°C)	Vcc Range (V)	Maximum Supply Current (µA)	Features	Packages
TC642	Fan Manager	Note 1	Note 1	-40 to +85	+3.0 to +5.5	1,000	FanSense™ Fan Monitor, minimum fan speed control	8-Pin PDIP, 8-Pin SOIC, 8-Pin MSOP
TC642B	Fan Manager	Note 1	Note 1	-40 to +85	+3.0 to +5.5	400	FanSense™ Fan Monitor, minimum fan speed control, fan auto-restart	8-Pin PDIP, 8-Pin SOIC, 8-Pin MSOP
TC646	Fan Manager	Note 1	Note 1	-40 to +85	+3.0 to +5.5	1,000	FanSense™ Fan Monitor, auto-shutdown	8-Pin PDIP, 8-Pin SOIC, 8-Pin MSOP
TC646B	Fan Manager	Note 1	Note 1	-40 to +85	+3.0 to +5.5	400	FanSense™ Fan Monitor, auto-shutdown, fan auto-restart	8-Pin PDIP, 8-Pin SOIC, 8-Pin MSOP

**NOTE 1:** These devices use an external temperature sensor. Accuracy of the total solution is a function of the accuracy of the external sensor.



**THERMAL MANAGEMENT PRODUCTS – Brushless DC Fan Controllers and Fan Fault Detectors (continued)**

Part #	Description	Typical Accuracy (°C)	Maximum Accuracy @ 25°C (°C)	Maximum Temperature Range (°C)	Vcc Range (V)	Maximum Supply Current (µA)	Features	Packages
TC647	Fan Manager	Note 1	Note 1	-40 to +85	+3.0 to +5.5	1,000	FanSense™ Fan Monitor, minimum fan speed control	8-Pin PDIP, 8-Pin SOIC, 8-Pin MSOP
TC647B	Fan Manager	Note 1	Note 1	-40 to +85	+3.0 to +5.5	400	FanSense™ Fan Monitor, minimum fan speed control, fan auto-restart	8-Pin PDIP, 8-Pin SOIC, 8-Pin MSOP
TC648	Fan Manager	Note 1	Note 1	-40 to +85	+3.0 to +5.5	1,000	Over-temperature alert, auto-shutdown	8-Pin PDIP, 8-Pin SOIC, 8-Pin MSOP
TC648B	Fan Manager	Note 1	Note 1	-40 to +85	+3.0 to +5.5	400	Over-temperature alert, auto-shutdown, fan auto-restart	8-Pin PDIP, 8-Pin SOIC, 8-Pin MSOP
TC649	Fan Manager	Note 1	Note 1	-40 to +85	+3.0 to +5.5	1,000	FanSense™ Fan Monitor, auto-shutdown	8-Pin PDIP, 8-Pin SOIC, 8-Pin MSOP
TC649B	Fan Manager	Note 1	Note 1	-40 to +85	+3.0 to +5.5	400	FanSense™ Fan Monitor, auto-shutdown, fan auto-restart	8-Pin PDIP, 8-Pin SOIC, 8-Pin MSOP
TC650	Fan Manager	±1	±3	-40 to +125	+2.8 to +5.5	90	Over-temperature alert	8-Pin MSOP
TC651	Fan Manager	±1	±3	-40 to +125	+2.8 to +5.5	90	Over-temperature alert, auto-shutdown	8-Pin MSOP
TC652	Fan Manager	±1	±3	-40 to +125	+2.8 to +5.5	90	FanSense™ Fan Monitor, over-temperature alert	8-Pin MSOP
TC653	Fan Manager	±1	±3	-40 to +125	+2.8 to +5.5	90	FanSense™ Fan Monitor, over-temperature alert, auto-shutdown	8-Pin MSOP
TC654	Dual SMBus Fan Manager	Note 1	Note 1	-40 to +85	+3.0 to +5.5	320	FanSense™ Fan Monitor, RPM data	10-Pin MSOP
TC655	Dual SMBus Fan Manager	Note 1	Note 1	-40 to +85	+3.0 to +5.5	320	FanSense™ Fan Monitor, RPM data, over-temperature alert	10-Pin MSOP
TC664	Single SMBus Fan Manager	Note 1	Note 1	-40 to +85	+3.0 to +5.5	320	FanSense™ Fan Monitor, RPM data	10-Pin MSOP
TC665	Single SMBus Fan Manager	Note 1	Note 1	-40 to +85	+3.0 to +5.5	320	FanSense™ Fan Monitor, RPM data, over-temperature alert	10-Pin MSOP
TC670	Predictive Fan Fault Detector	N/A	N/A	-40 to +85	+3.0 to +5.5	150	FanSense™ Fan Monitor, programmable threshold	6-Pin SOT-23

**NOTE 1:** These devices use an external temperature sensor. Accuracy of the total solution is a function of the accuracy of the external sensor.

**POWER MANAGEMENT – Voltage References**

Part #	Vcc Range (V)	Output Voltage (V)	Max. Load Current (mA)	Initial Accuracy (max.%)	Temperature Coefficient (ppm/°C)	Max. Supply Current (µA @ 25°C)	Packages
MCP1525	2.7 to 5.5	2.5	±2	±1	50	100	3-Pin TO-92, 3-Pin SOT-23B
MCP1541	4.3 to 5.5	4.096	±2	±1	50	100	3-Pin TO-92, 3-Pin SOT-23B

**POWER MANAGEMENT – Linear Regulators**

Part #	Max. Input Voltage (V)	Output Voltage (V)	Output Current (mA)	Junction Temperature Range (°C)	Typical Active Current (µA)	Typical Dropout Voltage @ Max. I <sub>OUT</sub> (mV)	Typical Output Voltage Accuracy (%)	Features	Packages
<b>50 mA to 250 mA Low Dropout Linear Regulators</b>									
TC2014	6.0	1.8, 2.7, 2.8, 3.0, 3.3	50	-40 to +125	55	45	±0.4	Shutdown, Reference bypass input	5-Pin SOT-23A
TC1014	6.0	1.8, 2.5, 2.7, 2.8, 2.85, 3.0, 3.3, 3.6, 4.0, 5.0	50	-40 to +125	50	85	±0.5	Shutdown, Reference bypass input	5-Pin SOT-23A
TC2054	6.0	1.8, 2.7, 2.8, 3.0, 3.3	50	-40 to +125	55	45	±0.4	Shutdown, Error output	5-Pin SOT-23A
TC1054	6.0	1.8, 2.5, 2.7, 2.8, 2.85, 3.0, 3.3, 3.6, 4.0, 5.0	50	-40 to +125	50	85	±0.5	Shutdown, Error output	5-Pin SOT-23A
TC1070	6.0	1.23 → V <sub>IN</sub>	50	-40 to +125	50	85	—	Shutdown, Adjustable	5-Pin SOT-23A
TC1072	6.0	2.5, 2.7, 2.8, 2.85, 3.0, 3.3, 3.6, 4.0, 5.0	50	-40 to +125	50	85	±0.5	Shutdown, Reference bypass input, Error output	6-Pin SOT-23A
TC1223	6.0	2.5, 2.7, 2.8, 3.0, 3.3, 3.6, 4.0, 5.0	50	-40 to +125	50	85	±0.5	Shutdown	5-Pin SOT-23A
TC1016	6.0	1.8, 2.7, 2.8, 3.0	80	-40 to +125	50	150	±0.5	Shutdown	5-Pin SC-70
TC2015	6.0	1.8, 2.7, 2.8, 3.0, 3.3	100	-40 to +125	55	90	±0.4	Shutdown, Reference bypass input	5-Pin SOT-23A
TC1015	6.0	1.8, 2.5, 2.7, 2.8, 2.85, 3.0, 3.3, 3.6, 4.0, 5.0	100	-40 to +125	50	180	±0.5	Shutdown, Reference bypass input	5-Pin SOT-23A
TC2055	6.0	1.8, 2.7, 2.8, 3.0, 3.3	100	-40 to +125	55	90	±0.4	Shutdown, Error output	5-Pin SOT-23A
TC1055	6.0	1.8, 2.5, 2.7, 2.8, 2.85, 3.0, 3.3, 3.6, 4.0, 5.0	100	-40 to +125	50	180	±0.5	Shutdown, Error output	5-Pin SOT-23A
TC1071	6.0	1.23 → V <sub>IN</sub>	100	-40 to +125	50	180	—	Shutdown, Adjustable	5-Pin SOT-23A
TC1073	6.0	2.5, 2.7, 2.8, 2.85, 3.0, 3.3, 3.6, 4.0, 5.0	100	-40 to +125	50	180	±0.5	Shutdown, Reference bypass input, Error output	6-Pin SOT-23A
TC1224	6.0	2.5, 2.7, 2.8, 3.0, 3.3, 3.6, 4.0, 5.0	100	-40 to +125	50	180	±0.5	Shutdown	5-Pin SOT-23A
TC1188	6.0	1.8, 2.8, 2.84, 3.15	120	-40 to +125	50	130	±0.5	Shutdown	5-Pin SOT-23A
TC1189	6.0	1.8, 2.8, 2.84, 3.15	120	-40 to +125	50	130	±0.5	Shutdown	5-Pin SOT-23A
TC2185	6.0	1.8, 2.7, 2.8, 3.0, 3.3	150	-40 to +125	55	140	±0.4	Shutdown, Reference bypass input	5-Pin SOT-23A
TC1185	6.0	1.8, 2.5, 2.7, 2.8, 2.85, 3.0, 3.3, 3.6, 4.0, 5.0	150	-40 to +125	50	270	±0.5	Shutdown, Reference bypass input	5-Pin SOT-23A
TC2186	6.0	1.8, 2.7, 2.8, 3.0, 3.3	150	-40 to +125	55	140	±0.4	Shutdown, Error output	5-Pin SOT-23A
TC1186	6.0	1.8, 2.5, 2.7, 2.8, 2.85, 3.0, 3.3, 3.6, 4.0, 5.0	150	-40 to +125	50	270	±0.5	Shutdown, Error output	5-Pin SOT-23A
TC1187	6.0	1.23 → V <sub>IN</sub>	150	-40 to +125	50	270	—	Shutdown, Adjustable	5-Pin SOT-23A
TC1017	6.0	1.8, 2.6, 2.7, 2.8, 2.85, 2.9, 3.3, 3.4	150	-40 to +125	53	285	±0.5	Shutdown	5-Pin SOT-23A, 5-Pin SC-70
MCP1700	6.0	1.2, 1.8, 2.5, 3.0, 3.3, 5.0	250	-40 to +125	1.0	300	±0.4	1.0 µF ceramic cap stable, Short-circuit protection	3-Pin TO-92, 3-Pin SOT-23A, 3-Pin SOT-89
MCP1701	10	1.8, 2.5, 3.0, 3.3, 5.0	250	-40 to +85	1.1	380	±0.5	10V max. input voltage	3-Pin SOT-23A, 3-Pin SOT-89, 3-Pin TO-92
MCP1702	12	1.2, 1.5, 1.8, 2.5, 2.8, 3.0, 3.5, 4.0, 5.0	250	-40 to +125	2	650	±0.4	Ultra-low ground current, 12V V <sub>IN</sub> max.	3-Pin SOT-23A, 3-Pin SOT-89, 3-Pin TO-92

**NOTE**  
 1: Depending on external transistor configuration.  
 2: Each channel (for Dual and Quad LDOs).  
 3: LDOs with shutdown (except Power-Management Combination Products as indicated) have typical shutdown currents of 0.05 µA.

**POWER MANAGEMENT – Linear Regulators (continued)**

Part #	Max. Input Voltage (V)	Output Voltage (V)	Output Current (mA)	Junction Temperature Range (°C)	Typical Active Current (µA)	Typical Dropout Voltage @ Max. I <sub>OUT</sub> (mV)	Typical Output Voltage Accuracy (%)	Features	Packages
<b>300 mA Low Dropout Linear Regulators</b>									
TC1107	6.0	2.5, 2.7, 2.8, 3.0, 3.3, 5.0	300	-40 to +125	50	240	±0.5	Shutdown, Reference bypass input	8-Pin MSOP, 8-Pin SOIC
TC1108	6.0	2.5, 2.7, 2.8, 3.0, 3.3, 5.0	300	-40 to +125	50	240	±0.5		3-Pin SOT-223
TC1173	6.0	2.5, 2.7, 2.8, 3.0, 3.3, 5.0	300	-40 to +125	50	240	±0.5	Shutdown, Reference bypass input, Error output	8-Pin MSOP, 8-Pin SOIC
TC1174	6.0	1.23 → V <sub>IN</sub>	300	-40 to +125	50	240	—	Shutdown, Reference bypass input, Adjustable	8-Pin MSOP, 8-Pin SOIC
TC1269	6.0	2.5, 2.8, 3.0, 3.3, 5.0	300	-40 to +125	50	240	±0.5	Shutdown, Reference bypass input	8-Pin MSOP
<b>500 mA to 800 mA Low Dropout Linear Regulators</b>									
TC1262	6.0	2.5, 2.8, 3.0, 3.3, 5.0	500	-40 to +125	80	350	±0.5		3-Pin TO-220, 3-Pin DDPAK, 3-Pin SOT-223
TC1263	6.0	2.5, 2.8, 3.0, 3.3, 5.0	500	-40 to +125	80	350	±0.5	Shutdown, Reference bypass input, Error output	8-Pin SOIC, 5-Pin TO-220, 5-Pin DDPAK
TC1268	6.0	2.5	500	-40 to +125	80	350	±0.5	Shutdown, Reference bypass input, Error output	8-Pin SOIC
TC1264	6.0	1.8, 2.5, 3.0, 3.3	800	-40 to +125	80	450	±0.5		3-Pin TO-220, 3-Pin DDPAK, 3-Pin SOT-223
TC1265	6.0	1.8, 2.5, 3.0, 3.3	800	-40 to +125	80	450	±0.5	Shutdown, Reference bypass input, Error output	8-Pin SOIC, 5-Pin TO-220, 5-Pin DDPAK
TC2117	6.0	1.8, 2.5, 3.0, 3.3	800	-40 to +125	80	600	±0.5		3-Pin SOT-223, 3-Pin DDPAK
<b>1A and Above Low Dropout Linear Regulators</b>									
MCP1726	6.0	Fixed: 5, 3.3, 3, 2.5, 1.8, 1.2, 0.8 Adjustable: 0.8 to 5.0	1000	-40 to +125	140	300	±0.4	Ceramic output capacitor stable, Shutdown, Cdelay, Power Good	8-Pin 3x3 DFN, 8-Pin SOIC
MCP1727	6.0	Fixed: 5, 3.3, 3, 2.5, 1.8, 1.2, 0.8 Adjustable: 0.8 to 5.0	1500	-40 to +125	140	330	±0.5	Ceramic output capacitor stable, Shutdown, Cdelay, Power Good	8-Pin 3x3 DFN, 8-Pin SOIC
MCP1827	6.0	Fixed: 5, 3.3, 3, 2.5, 1.8, 1.2, 0.8 Adjustable: 0.8 to 5.0	1500	-40 to +125	140	330	±0.5	Ceramic output capacitor stable, Shutdown, Power Good	5-Pin DDPAK, 5-Pin TO-220
MCP1827S	6.0	Fixed: 5, 3.3, 3, 2.5, 1.8, 1.2, 0.8	1500	-40 to +125	140	330	±0.5	Ceramic output capacitor stable	3-Pin DDPAK, 3-Pin TO-220
<b>Application Specific Low Dropout Linear Regulators</b>									
TC1266	6.0	3.3	200	-5 to +70	230	200	±1.0	PCI compliant	8-Pin SOIC, 8-Pin MSOP
TC1267	6.0	3.3	400	-5 to +70	230	300	±1.0	PCI compliant	5-Pin DDPAK
TC57	8	2.5, 3.0, 3.3	4,000 <sup>(1)</sup>	-40 to +85	50	100 <sup>(1)</sup>	±2.0	Shutdown, External transistor	5-Pin SOT-23A
TC59	-10	-3.0, -5.0	100	-40 to +85	3	380	±0.5	Negative LDO	3-Pin SOT-23A
<b>Power Management Combination Products</b>									
TC1300 <sup>(2)</sup>	6.0	2.5, 2.7, 2.8, 2.85, 3.0, 3.3	300	-40 to +125	80	210	±0.5	Shutdown, Reference bypass input, LDO plus Reset output	8-Pin MSOP
TC1301A <sup>(3)</sup>	6.0	LDO1: 1.5-3.3 LDO2: 1.5-3.3	LDO1: 300 LDO2: 150	-40 to +125	103	LDO1: 104 LDO2: 150	±0.5	Dual LDO plus Reset output, Shutdown, Reference bypass, Voltage detect	8-Pin MSOP, 8-Pin 3x3 DFN

NOTE 1: Depending on external transistor configuration.

2: Each channel (for Dual and Quad LDOs).

3: LDOs with shutdown (except Power-Management Combination Products as indicated) have typical shutdown currents of 0.05 µA.

**POWER MANAGEMENT – Linear Regulators (continued)**

Part #	Max. Input Voltage (V)	Output Voltage (V)	Output Current (mA)	Junction Temperature Range (°C)	Typical Active Current (µA)	Typical Dropout Voltage @ Max. I <sub>OUT</sub> (mV)	Typical Output Voltage Accuracy (%)	Features	Packages
<b>Power-Management Combination Products (continued)</b>									
TC1301B <sup>(3)</sup>	6.0	LDO1: 1.5-3.3 LDO2: 1.5-3.3	LDO1: 300 LDO2: 150	-40 to +125	114	LDO1: 104 LDO2: 150	±0.5	Dual LDO plus Reset, per channel output shutdown, Reference bypass	8-Pin MSOP, 8-Pin 3x3 DFN
TC1302A <sup>(3)</sup>	6.0	LDO1: 1.5-3.3 LDO2: 1.5-3.3	LDO1: 300 LDO2: 150	-40 to +125	103	LDO1: 104 LDO2: 150	±0.5	Dual LDO, Output shutdown reference bypass, Voltage detect	8-Pin MSOP, 8-Pin 3x3 DFN
TC1302B <sup>(3)</sup>	6.0	LDO1: 1.5-3.3 LDO2: 1.5-3.3	LDO1: 300 LDO2: 150	-40 to +125	114	LDO1: 104 LDO2: 150	±0.5	Dual LDO, per channel output shutdown, Reference bypass	8-Pin MSOP, 8-Pin 3x3 DFN
TC1305	6.0	2.5, 2.8, 3.0	150 <sup>(2)</sup>	-40 to +125	120	240	±0.5	Dual LDO plus Reset output, Reference bypass input, Shutdown, Select Mode™, selectable output voltages	10-Pin MSOP
TC1306	6.0	1.8, 2.8, 3.0	150 <sup>(2)</sup>	-40 to +125	120	240	±0.5	Dual LDO plus Reset output, Shutdown, Select Mode™, selectable output voltages	8-Pin MSOP
TC1307 <sup>(3)</sup>	6.0	1.8, 2.5, 2.8, 3.0	150 <sup>(2)</sup>	-40 to +125	220	200	±0.5	Quad LDO plus Reset output, Shutdown, Select Mode™, selectable output voltage	16-Pin QSOP

**NOTE 1:** Depending on external transistor configuration.

**2:** Each channel (for Dual and Quad LDOs).

**3:** LDOs with shutdown (except Power-Management Combination Products as indicated) have typical shutdown currents of 0.05 µA.

**POWER MANAGEMENT – Switching Regulators**

Part #	Description	Input Voltage Range (V)	Output Voltage (V)	Operating Temperature Range (°C)	Control Scheme	Switching Frequency (kHz)	Typical Active Current (µA)	Output Current (mA)	Features	Packages
MCP1601	Synchronous Buck Regulator	2.7 to 5.5	0.9V to V <sub>IN</sub>	-40 to +85	PFM/PWM/LDO	750	825 (PWM) 125 (PFM)	500	UVLO, Auto-switching, LDO	8-Pin MSOP
MCP1612	Synchronous Buck DC/DC Regulator	2.7 to V <sub>IN</sub>	0.8 to 5.5	-40 to +85	Constant frequency PWM	1400	10,000	1000	Overall efficiency >94% soft start, over-temperature and over-current protection	8-Pin MSOP, 8-Pin 3x3 DFN
MCP1650	Step-up DC/DC Controller	2.7 to 5.5	2.5 to ext. tx limited	-40 to +125	Constant frequency, 2 fixed DC	750	120	560/440	2 duty cycles for min. and max. loads, shutdown control, UVLO, soft start	8-Pin MSOP
MCP1651	Step-up DC/DC Controller	2.7 to 5.5	2.5 to ext. tx limited	-40 to +125	Constant frequency, 2 fixed DC	750	120	560/440	2 duty cycles for min. and max. loads, shutdown control, UVLO, soft start	8-Pin MSOP
MCP1652	Step-up DC/DC Controller	2.7 to 5.5	2.5 to ext. tx limited	-40 to +125	Constant frequency, 2 fixed DC	750	120	560/440	2 duty cycles for min. and max. loads, shutdown control, Power Good indicator, UVLO, soft start	8-Pin MSOP
MCP1653	Step-up DC/DC Controller	2.7 to 5.5	2.5 to ext. tx limited	-40 to +125	Constant frequency, 2 fixed DC	750	120	560/440	2 duty cycles for min. and max. loads, shutdown control, low battery detect, Power Good indicator, UVLO, soft start	10-Pin MSOP
TC105	Step-down DC/DC Controller	2.2 to 10	3.0, 3.3, 5.0	-40 to +85	PFM/PWM	300	57	1,000	Low-Power Shutdown mode	5-Pin SOT-23A
TC120	Step-down Regulator/Controller Combination	1.8 to 10	3.0, 3.3, 5.0	-40 to +85	PFM/PWM	300	52	2,000	Soft-start, Low-Power Shutdown mode	8-Pin SOP
TC125	Step-up DC/DC Regulator	0.9 to 10	3.0, 3.3, 5.0	-40 to +85	PFM	100	20	80	Low-Power Shutdown mode	5-Pin SOT-23A
TC126	Step-up DC/DC Regulator	0.9 to 10	3.0, 3.3, 5.0	-40 to +85	PFM	100	20	80	Feedback voltage sensing	5-Pin SOT-23A

### POWER MANAGEMENT – Switching Regulators (continued)

Part #	Description	Input Voltage Range (V)	Output Voltage (V)	Operating Temperature Range (°C)	Control Scheme	Switching Frequency (kHz)	Typical Active Current (µA)	Output Current (mA)	Features	Packages
TC115	Step-up DC/DC Regulator	0.9 to 10	3.0, 3.3, 5.0	-40 to +85	PFM/PWM	100	80	140	Feedback voltage sensing, Low-Power Shutdown mode	5-Pin SOT-89
TC110	Step-up DC/DC Controller	2.0 to 10	3.0, 3.3, 5.0	-40 to +85	PFM/PWM	100/300	50/120	300	Soft-start, Low-Power Shutdown mode	5-Pin SOT-23A
TC1303	Synchronous Buck Regulator, LDO w/Power Good	2.7 to 5.5	DC/DC: 0.8 to 4.5 LDO: 1.5 to 3.3	-40 to +85	PFM/PWM	2000	65/600	DC/DC: 500 mA LDO: 300 mA	PFM/PWM auto-switching, Power Good output	10-Pin MSOP, 10-Pin 3x3 DFN
TC1304	Synchronous Buck Regulator, LDO	2.7 to 5.5	DC/DC: 0.8 to 4.5 LDO: 1.5 to 3.3	-40 to +85	PFM/PWM	2000	65/600	DC/DC: 500 mA LDO: 300 mA	PFM/PWM auto-switching, Power sequencing	10-Pin MSOP, 10-Pin 3x3 DFN
TC1313	Synchronous Buck Regulator, LDO	2.7 to 5.5	DC/DC: 0.8 to 4.5 LDO: 1.5 to 3.3	-40 to +85	PFM/PWM	2000	65/600	DC/DC: 500 mA LDO: 300 mA	PFM/PWM auto-switching	10-Pin MSOP, 10-Pin 3x3 DFN

### POWER MANAGEMENT – PWM Controllers

Part #	Description	Input Voltage Range (V)	Output Voltage (V)	Operating Temperature Range (°C)	Control Scheme	Switching Frequency (kHz)	Typical Active Supply (µA)	Output Current (mA)	Features	Packages
MCP1630	High-speed PWM to use with PIC® MCUs	2.7 to 5.5	V <sub>SS</sub> + 0.2V to V <sub>DD</sub> - 0.2V	-40 to +125	Cycle-by-Cycle DC control	1000	2.5	±10	UVLO, current sense to VEXT, response <25 ns	8-Pin MSOP
MCP1630V	High-speed PWM to use with PIC® MCUs	2.7 to 5.5	V <sub>SS</sub> + 0.2V to V <sub>DD</sub> - 0.2V	-40 to +125	Cycle-by-Cycle DC control	1000	2.5	±10	Voltage mode and Average Current mode	8-Pin MSOP

### POWER MANAGEMENT – Charge Pump DC-to-DC Converters

Part #	Input Voltage Range (V)	Output Voltage (V)	Operating Temperature Range (°C)	Maximum Input Current <sup>(1)</sup> (µA)	Typical Active Output Current (mA)	Features	Packages
<b>Inverting or Doubling Charge Pumps</b>							
TC1044S	1.5 to 12	V <sub>OUT</sub> = -V <sub>IN</sub> or V <sub>OUT</sub> = 2 V <sub>IN</sub>	-40 to +85	160	20	85 kHz oscillator, Boost mode	8-Pin PDIP, 8-Pin SOIC
TC7660	1.5 to 10	V <sub>OUT</sub> = -V <sub>IN</sub> or V <sub>OUT</sub> = 2 V <sub>IN</sub>	-40 to +85	180	20	10 kHz oscillator	8-Pin PDIP, 8-Pin SOIC
TC7660H	1.5 to 10	V <sub>OUT</sub> = -V <sub>IN</sub> or V <sub>OUT</sub> = 2 V <sub>IN</sub>	-40 to +85	1,000	20	120 kHz oscillator	8-Pin PDIP, 8-Pin SOIC
TC7660S	1.5 to 12	V <sub>OUT</sub> = -V <sub>IN</sub> or V <sub>OUT</sub> = 2 V <sub>IN</sub>	-40 to +85	160	20	45 kHz oscillator, Boost mode	8-Pin PDIP, 8-Pin SOIC
TC7662B	1.5 to 15	V <sub>OUT</sub> = -V <sub>IN</sub> or V <sub>OUT</sub> = 2 V <sub>IN</sub>	-40 to +85	180	20	35 kHz oscillator, Boost mode	8-Pin PDIP, 8-Pin SOIC
TC1219	1.5 to 5.5	V <sub>OUT</sub> = -V <sub>IN</sub> or V <sub>OUT</sub> = 2 V <sub>IN</sub>	-40 to +85	115	25	12 kHz oscillator, Low-Power Shutdown mode	6-Pin SOT-23A
TC1220	1.5 to 5.5	V <sub>OUT</sub> = -V <sub>IN</sub> or V <sub>OUT</sub> = 2 V <sub>IN</sub>	-40 to +85	325	25	35 kHz oscillator, Low-Power Shutdown mode	6-Pin SOT-23A
TC1221	1.8 to 5.5	V <sub>OUT</sub> = -V <sub>IN</sub> or V <sub>OUT</sub> = 2 V <sub>IN</sub>	-40 to +85	600	25	Shutdown, 125 kHz oscillator	6-Pin SOT-23A
TC1222	1.8 to 5.5	V <sub>OUT</sub> = -V <sub>IN</sub> or V <sub>OUT</sub> = 2 V <sub>IN</sub>	-40 to +85	2,800	25	Shutdown, 750 kHz oscillator	6-Pin SOT-23A
TCM828	1.5 to 5.5	V <sub>OUT</sub> = -V <sub>IN</sub> or V <sub>OUT</sub> = 2 V <sub>IN</sub>	-40 to +85	90	25	12 kHz oscillator	5-Pin SOT-23A
TCM829	1.5 to 5.5	V <sub>OUT</sub> = -V <sub>IN</sub> or V <sub>OUT</sub> = 2 V <sub>IN</sub>	-40 to +85	260	25	35 kHz oscillator	5-Pin SOT-23A
TC1240	2.5 to 4.0	V <sub>OUT</sub> = 2 V <sub>IN</sub>	-40 to +85	900	40	Shutdown, 160 kHz oscillator	6-Pin SOT-23A
TC1240A	2.5 to 5.5	V <sub>OUT</sub> = 2 V <sub>IN</sub>	-40 to +85	900	40	Shutdown, 160 kHz oscillator	6-Pin SOT-23A

NOTE 1: Measured at V<sub>DD</sub> = 5.0V at 25°C and no load.

**POWER MANAGEMENT – Charge Pump DC-to-DC Converters (continued)**

Part #	Input Voltage Range (V)	Output Voltage (V)	Operating Temperature Range (°C)	Maximum Input Current <sup>(1)</sup> (µA)	Typical Active Output Current (mA)	Features	Packages
<b>Inverting or Doubling Charge Pumps (continued)</b>							
TC7662A	3 to 18	VOUT = -VIN or VOUT = 2 VIN	-40 to +85	200	40	12 kHz oscillator	8-Pin PDIP
TC962	3 to 18	VOUT = -VIN or VOUT = 2 VIN	-40 to +85	200	80		8-Pin PDIP, 16-Pin SOIC
TC1121	2.4 to 5.5	VOUT = -VIN or VOUT = 2 VIN	-40 to +85	100	100	Low-Power Shutdown mode	8-Pin MSOP, 8-Pin PDIP, 8-Pin SOIC
<b>Multi-Function Charge Pumps</b>							
TCM680	2.0 to 5.5	VOUT = ±2 VIN	-40 to +85	1,000	±10	Generates +6V from +3V or ±10V from +5V	8-Pin PDIP, 8-Pin SOIC
<b>Inverting and Doubling Charge Pumps</b>							
TC682	2.4 to 5.5	VOUT = -2 VIN	-40 to +85	400	10	12 kHz oscillator	8-Pin PDIP, 8-Pin SOIC
<b>Regulated Charge Pumps</b>							
MCP1252	2.1/2.7 to 5.5 2.0 to 5.5	Selectable 3.3V or 5.0V or Adjustable 1.5V to 5.5V	-40 to +85	120	120 mA for VIN>3.0V	Power Good output, 650 kHz oscillator	8-Pin MSOP
MCP1253	2.1/2.7 to 5.5 2.0 to 5.5	Selectable 3.3V or 5.0V or Adjustable 1.5V to 5.5V	-40 to +85	120	120 mA for VIN>3.0V	Power Good output, 1 MHz oscillator	8-Pin MSOP
MCP1256	1.8 to 3.6	3.3	-40 to +85	100	100	Power Good, Sleep mode	10-Pin MSOP, 10-Pin 3x3 DFN
MCP1257	1.8 to 3.6	3.3	-40 to +85	100	100	Sleep mode, low battery indication	10-Pin MSOP, 10-Pin 3x3 DFN
MCP1258	1.8 to 3.6	3.3	-40 to +85	100	100	Power Good output, input/output bypass	10-Pin MSOP, 10-Pin 3x3 DFN
MCP1259	1.8 to 3.6	3.3	-40 to +85	100	100	Low battery indication, input/output bypass	10-Pin MSOP, 10-Pin 3x3 DFN

NOTE 1: Measured at VDD = 5.0V at 25°C and no load.

**POWER MANAGEMENT – CPU/System Supervisors**

Part #	Vcc Range (V)	Operating Temperature Range (°C)	Nominal I Reset Voltage (V)	Reset Type	Output	Typical Reset Pulse Width (ms)	Typical Supply Current (µA)	Additional Features	Packages	Bond Options
MCP102	1.0 to 5.5	-40 to +125	4.63, 4.38, 3.08, 2.93, 2.63, 2.32, 1.9	Active-Low	CMOS Push-Pull	120	1		3-Pin SOT-23B, 3-Pin SC-70, 3-Pin TO-92	N/A
MCP103	1.0 to 5.5	-40 to +125	4.63, 4.38, 3.08, 2.93, 2.63, 2.32, 1.9	Active-Low	CMOS Push-Pull	120	1	Max. 809 Pinout	3-Pin SOT-23B, 3-Pin SC-70, 3-Pin TO-92	N/A
TC1272	1.2 to 5.5	-40 to +85	4.62, 4.37, 4.12	Active-Low	CMOS Push-Pull	200	17		3-Pin SOT-23B	N/A
TC1275	1.2 to 5.5	-40 to +85	3.06, 2.88, 2.55	Active-Low	CMOS Push-Pull	200	20		3-Pin SOT-23B	N/A
TCM809	1.2 to 5.5	-40 to +85	4.63, 4.38, 4.00, 3.08, 2.93, 2.63, 2.32	Active-Low	CMOS Push-Pull	240	12		3-Pin SOT-23B, 3-Pin SC-70	N/A
TC1270	1.2 to 5.5	-40 to +85	4.63, 4.38, 3.08, 2.93, 2.63, 1.75	Active-Low	CMOS Push-Pull	280	7	Manual Reset	4-Pin SOT-143	N/A
TCM811	1.0 to 5.5	-40 to +85	4.63, 4.38, 3.08, 2.93, 2.63, 1.75	Active-Low	CMOS Push-Pull	280	6	Manual Reset	4-Pin SOT-143	N/A
MCP100	1.0 to 5.5	-40 to +85	4.72, 4.62, 4.47, 4.37, 3.075, 2.92, 2.62	Active-Low	CMOS Push-Pull	350	45		3-Pin TO-92, 3-Pin SOT-23B	D, H
MCP809	1.0 to 5.5	-40 to +85	4.72, 4.62, 4.47, 4.37, 3.075, 2.92, 2.62	Active-Low	CMOS Push-Pull	350	45		3-Pin SOT-23B	N/A
TC1274	1.8 to 5.5	-40 to +85	4.62, 4.37, 4.13	Active-High	CMOS Push-Pull	200	17		3-Pin SOT-23B	N/A
TC1277	1.8 to 5.5	-40 to +85	3.06, 2.88, 2.55	Active-High	CMOS Push-Pull	200	20		3-Pin SOT-23B	N/A

**POWER MANAGEMENT – CPU/System Supervisors (continued)**

Part #	Vcc Range (V)	Operating Temperature Range (°C)	Nominal Reset Voltage (V)	Reset Type	Output	Typical Reset Pulse Width (ms)	Typical Supply Current (µA)	Additional Features	Packages	Bond Options
TCM810	1.2 to 5.5	-40 to +85	4.63, 4.38, 3.08, 2.93, 2.63, 2.32	Active-High	CMOS Push-Pull	240	12		3-Pin SOT-23B, 3-Pin SC-70	N/A
TC1271	1.2 to 5.5	-40 to +85	4.63, 4.38, 3.08, 2.93, 2.63, 1.75	Active-High	CMOS Push-Pull	280	7	Manual Reset	4-Pin SOT-143	N/A
TCM812	1.1 to 5.5	-40 to +85	4.63, 4.38, 3.08, 2.93, 2.63, 1.75	Active-High	CMOS Push-Pull	280	6	Manual Reset	4-Pin SOT-143	N/A
MCP101	1.0 to 5.5	-40 to +85	4.72, 4.62, 4.47, 4.37, 3.075, 2.92, 2.62	Active-High	CMOS Push-Pull	350	45		3-Pin TO-92, 3-Pin SOT-23B	D, H
MCP810	1.0 to 5.5	-40 to +85	4.72, 4.62, 4.47, 4.37, 3.075, 2.92, 2.62	Active-High	CMOS Push-Pull	350	45		3-Pin SOT-23B	N/A
MCP121	1.0 to 5.5	-40 to +125	1.9, 2.32, 2.63, 2.93, 3.08, 4.38, 4.63	Active-Low	Open-Drain	120	1		3-Pin SOT-23B, 3-Pin SC-70, 3-Pin TO-92	N/A
TC1273	1.2 to 5.5	-40 to +85	4.62, 4.37, 4.12	Active-Low	Open-Drain	200	17		3-Pin SOT-23B	N/A
TC1276	1.2 to 5.5	-40 to +85	3.06, 2.88, 2.55	Active-Low	Open-Drain	200	20		3-Pin SOT-23B	N/A
MCP120	1.0 to 5.5	-40 to +85	4.72, 4.62, 4.47, 4.37, 3.075, 2.92, 2.62	Active-Low	Open-Drain	350	45		3-Pin TO-92, 3-Pin SOT-23, 8-Pin SOIC	D, G, H
TC1279	1.2 to 5.5	-40 to +85	4.62, 4.37, 4.125	Active-Low	Open-Drain	350	900		3-Pin SOT-23B	N/A
MCP131	1.0 to 5.5	-40 to +125	1.9, 2.32, 2.63, 2.93, 3.08, 4.38, 4.63	Active-Low	Open-Drain	120	1	100kΩ Internal Pull-up Resistor	3-Pin SOT-23B, 3-Pin SC-70, 3-Pin TO-92	N/A
MCP130	1.0 to 5.5	-40 to +85	4.72, 4.62, 4.47, 4.37, 3.075, 2.92, 2.62	Active-Low	Open-Drain w/ 5 kΩhm Pull-up	350	45		3-Pin TO-92, 3-Pin SOT-23, 8-Pin SOIC	D, F, H
TC1278	1.2 to 5.5	-40 to +85	4.62, 4.37, 4.125	Active-High	Open-Drain	350	900		3-Pin SOT-23B	N/A
MCP1316	1.0 to 5.5	-40 to +125	2.9, 4.6	Active-Low	CMOS Push-Pull	200	5	Watchdog Input (WDI), Time-out = 1.6 sec., Manual reset	5-Pin SOT-23	N/A
MCP1317	1.0 to 5.5	-40 to +125	2.9, 4.6	Active-High	CMOS Push-Pull	200	5	Watchdog Input (WDI), Time-out = 1.6 sec., Manual reset	5-Pin SOT-23	N/A
MCP1318	1.0 to 5.5	-40 to +125	4.6	Active-Low/High	CMOS Push-Pull	200	5	Watchdog Input (WDI), Time-out = 1.6 sec.	5-Pin SOT-23	N/A
MCP1319	1.0 to 5.5	-40 to +125	4.6	Active-Low/High	CMOS Push-Pull	200	1	Manual reset	5-Pin SOT-23	N/A
MCP1320	1.0 to 5.5	-40 to +125	2.9, 4.6	Active-Low	Open-Drain	200	5	Watchdog Input (WDI), Time-out = 1.6 sec., Manual Reset	5-Pin SOT-23	N/A
MCP1321	1.0 to 5.5	-40 to +125	4.6	Active-Low	Open-Drain/CMOS Push-Pull	200	5	Watchdog Input (WDI), Time-out = 1.6 sec., Manual Reset (Active-Low Open-Drain, Active-High Push-Pull)	5-Pin SOT-23	N/A
MCP1322	1.0 to 5.5	-40 to +125	4.6	Active-High	Open-Drain/CMOS Push-Pull	200	1	Manual Reset, two Reset outputs (Active-Low Open-Drain, Active-High Push-Pull)	5-Pin SOT-23	N/A
TC1232	4.5 to 5.5	-40 to +85	4.62, 4.37	Active-Low/High	Open-Drain	610	50	Watchdog Timer	8-Pin PDIP, 8-Pin SOIC, 16-Pin SOIC	N/A
TC32M	4.5 to 5.5	-40 to +85	4.5	Active-Low	Open-Drain	700	50	Watchdog Timer	3-Pin TO-92, 3-Pin SOT-223	N/A

**POWER MANAGEMENT – Voltage Detectors**

Part #	V <sub>CC</sub> Range (V)	Operating Temperature Range (°C)	Nominal Reset Voltage (V)	Reset Type	Output	Minimum Reset Pulse Width (ms)	Typical Supply Current (µA)	Features	Packages
MCP111	1.0 to 5.5	-40 to +125	4.63, 4.38, 3.08, 2.93, 2.63, 2.32, 1.90	Active-Low	Open-Drain	—	1		3-Pin SOT-23B, 3-Pin TO-92, 3-Pin SC-70, 3-Pin SOT-89
MCP112	1.0 to 5.5	-40 to +125	4.63, 4.38, 3.08, 2.93, 2.63, 2.32, 1.90	Active-Low	CMOS Push-Pull	—	1		3-Pin SOT-23B, 3-Pin TO-92, 3-Pin SC-70, 3-Pin SOT-89
TC51	0.7 to 10	-40 to +85	3.0, 2.7, 2.2	Active-Low	Open-Drain	50	1	Reset delay	3-Pin SOT-23A
TC52	1.5 to 10	-40 to +85	4.5/2.7, 3.0/2.7	Active-Low	Open-Drain	—	2	Dual channel	5-Pin SOT-23A
TC53	1.5 to 10	-40 to +85	2.9, 2.7, 2.2	Active-Low	CMOS Push-Pull or Open-Drain	—	1		5-Pin SOT-23A
TC54	0.7 to 10	-40 to +85	4.3, 4.2, 3.0, 2.9, 2.7, 2.1, 1.4	Active-Low	CMOS Push-Pull or Open-Drain	—	1		3-Pin SOT-23A, 3-Pin SOT-89, 3-Pin TO-92

**POWER MANAGEMENT – Power MOSFET Drivers**

Part #	Configuration	Operating Temperature Range (°C)	Peak Output Current (A)	Output Resistance (R <sub>th/RL</sub> ) (Max. Ω @ 25°C)	Max. Supply Voltage (V)	Input/Output Delay (td1, td2) <sup>(1)</sup> (ns)	Packages
<b>Low-Side Drivers, 0.5A to 1.2A Peak Output Current</b>							
TC1410	Single, Inverting	-40 to +85	0.5	22/22	16	30/30	8-Pin PDIP, 8-Pin SOIC, 8-Pin MSOP
TC1410N	Single, Non-inverting	-40 to +85	0.5	22/22	16	30/30	8-Pin PDIP, 8-Pin SOIC, 8-Pin MSOP
TC1411	Single, Inverting	-40 to +85	1	11/11	16	30/30	8-Pin PDIP, 8-Pin SOIC, 8-Pin MSOP
TC1411N	Single, Non-inverting	-40 to +85	1	11/11	16	30/30	8-Pin PDIP, 8-Pin SOIC, 8-Pin MSOP
TC1426	Dual, Inverting	0 to +70	1.2	18/18	16	75/75	8-Pin PDIP, 8-Pin SOIC
TC1427	Dual, Non-inverting	0 to +70	1.2	18/18	16	75/75	8-Pin PDIP, 8-Pin SOIC
TC1428	Dual, Inverting and Non-inverting	0 to +70	1.2	18/18	16	75/75	8-Pin PDIP, 8-Pin SOIC
TC4467	Quad, Inverting	-40 to +85	1.2	15/15	18	40/40	14-Pin PDIP, 16-Pin SOIC (W)
TC4468	Quad, Non-inverting	-40 to +85	1.2	15/15	18	40/40	14-Pin PDIP, 16-Pin SOIC (W)
TC4469	Quad, Non-inverting	-40 to +85	1.2	15/15	18	40/40	14-Pin PDIP, 16-Pin SOIC (W)
<b>Low-Side Drivers, 1.5A Peak Output Current</b>							
TC4403	Single, Non-inverting Floating Load Driver	-40 to +85	1.5	5/5	18	33/38	8-Pin PDIP
TC4426A	Dual, Inverting	-40 to +125	1.5	9/9	18	30/30	8-Pin PDIP, 8-Pin SOIC, 8-Pin DFN
TC4427A	Dual, Non-inverting	-40 to +125	1.5	9/9	18	30/30	8-Pin PDIP, 8-Pin SOIC, 8-Pin DFN
TC4428A	Dual, Inverting and Non-inverting	-40 to +125	1.5	9/9	18	30/30	8-Pin PDIP, 8-Pin SOIC, 8-Pin DFN
TC4426	Dual, Inverting	-40 to +125	1.5	10/10	18	20/40	8-Pin PDIP, 8-Pin SOIC, 8-Pin DFN, 8-Pin MSOP
TC4427	Dual, Non-inverting	-40 to +125	1.5	10/10	18	20/40	8-Pin PDIP, 8-Pin SOIC, 8-Pin DFN, 8-Pin MSOP
TC4428	Dual, Inverting and Non-inverting	-40 to +125	1.5	10/10	18	20/40	8-Pin PDIP, 8-Pin SOIC, 8-Pin DFN, 8-Pin MSOP
TC4426	Dual, Inverting	-40 to +85	1.5	15/10	18	50/75	8-Pin PDIP, 8-Pin SOIC

NOTE 1: \*td1 = delay time from input low-to-high transition to output transition. td2 = delay time from input high-to-low transition to output transition.



**POWER MANAGEMENT – Power MOSFET Drivers (continued)**

Part #	Configuration	Operating Temperature Range (°C)	Peak Output Current (A)	Output Resistance (R <sub>H</sub> /R <sub>L</sub> ) (Max. Ω @ 25°C)	Max. Supply Voltage (V)	Input/Output Delay (td1, td2) <sup>(1)</sup> (ns)	Packages
<b>Low-Side Drivers, 1.5A Peak Output Current (continued)</b>							
TC427	Dual, Non-inverting	-40 to +85	1.5	15/10	18	50/75	8-Pin PDIP, 8-Pin SOIC
TC428	Dual, Inverting and Non-inverting	-40 to +85	1.5	15/10	18	50/75	8-Pin PDIP, 8-Pin SOIC
TC4404	Dual, Inverting	-40 to +85	1.5	10/10	18	15/32	8-Pin PDIP, 8-Pin SOIC
TC4405	Dual, Non-inverting	-40 to +85	1.5	10/10	18	15/32	8-Pin PDIP, 8-Pin SOIC
<b>Low-Side Drivers, 2.0A to 12.0A Peak Output Current</b>							
TC1412	Single, Inverting	-40 to +85	2	6/6	16	35/35	8-Pin PDIP, 8-Pin SOIC, 8-Pin MSOP
TC1412N	Single, Non-inverting	-40 to +85	2	6/6	16	35/35	8-Pin PDIP, 8-Pin SOIC, 8-Pin MSOP
TC1413	Single, Inverting	-40 to +85	3	4/4	16	35/35	8-Pin PDIP, 8-Pin SOIC, 8-Pin MSOP
TC1413N	Single, Non-inverting	-40 to +85	3	4/4	16	35/35	8-Pin PDIP, 8-Pin SOIC, 8-Pin MSOP
TC4423A	Dual, Inverting	-40 to +125	3	3 (typ)/4 (typ)	18	40 (typ)/40 (typ)	8-Pin PDIP, 8-Pin SOIC, 8-Pin DFN
TC4424A	Dual, Non-inverting	-40 to +125	3	3 (typ)/4 (typ)	18	40 (typ)/40 (typ)	8-Pin PDIP, 8-Pin SOIC, 8-Pin DFN
TC4425A	Dual, Inverting and Non-inverting	-40 to +125	3	3 (typ)/4 (typ)	18	40 (typ)/40 (typ)	8-Pin PDIP, 8-Pin SOIC, 8-Pin DFN
TC4423	Dual, Inverting	-40 to +125	3	5/5	18	33/38	8-Pin PDIP, 16-Pin SOIC (W), 8-Pin DFN
TC4424	Dual, Non-inverting	-40 to +125	3	5/5	18	33/38	8-Pin PDIP, 16-Pin SOIC (W), 8-Pin DFN
TC4425	Dual, Inverting and Non-inverting	-40 to +125	3	5/5	18	33/38	8-Pin PDIP, 16-Pin SOIC (W), 8-Pin DFN
TC429	Single, Inverting	-40 to +85	6	2.5/2.5	18	53/60	8-Pin PDIP, 8-Pin DFN, 8-Pin SOIC
TC4420	Single, Non-inverting	-40 to +125	6	2.8/2.5	18	55/55	8-Pin PDIP, 8-Pin SOIC, 5-Pin TO-220, 8-Pin DFN
TC4429	Single, Inverting	-40 to +125	6	2.8/2.5	18	55/55	8-Pin PDIP, 8-Pin SOIC, 5-Pin TO-220, 8-Pin DFN
TC4421	Single, Inverting	-40 to +125	9	1.4 (typ)/1.7	18	30/33	8-Pin PDIP, 5-Pin TO-220, 8-Pin DFN
TC4421A	Single, Inverting	-40 to +125	9	1.25 (typ)/1.5	18	38/42	8-Pin PDIP, 8-Pin SOIC, 5-Pin TO-220, 8-Pin 6x5 DFN
TC4422	Single, Non-inverting	-40 to +125	9	1.4 (typ)/1.7	18	30/33	8-Pin PDIP, 5-Pin TO-220, 8-Pin DFN
TC4422A	Single, Non-inverting	-40 to +125	9	1.25 (typ)/1.5	18	38/42	8-Pin PDIP, 8-Pin SOIC, 5-Pin TO-220, 8-Pin 6x5 DFN
TC4451	Single, Inverting	-40 to +125	12	0.6 (typ)/1.5	18	15/15	8-Pin SOIC, 8-Pin PDIP, 8-Pin 6x5 DFN, 5-Pin TO-220, 5-Pin DDPACK
TC4452	Single, Non-inverting	-40 to +125	12	0.6 (typ)/1.5	18	15/15	8-Pin SOIC, 8-Pin PDIP, 8-Pin 6x5 DFN, 5-Pin TO-220, 5-Pin DDPACK
<b>High-Side/Low-Side Drivers</b>							
TC4626	Single, Inverting	-40 to +85	1.5	15/10	6	35/45	8-Pin PDIP, 16-Pin SOIC (W)
TC4627	Single, Non-inverting	-40 to +85	1.5	15/10	6	35/45	8-Pin PDIP, 16-Pin SOIC (W)
TC4431	Single, Inverting	-40 to +85	1.5	10/10	30	62/78	8-Pin PDIP, 8-Pin SOIC
TC4432	Single, Non-inverting	-40 to +85	1.5	10/10	30	62/78	8-Pin PDIP, 8-Pin SOIC

**NOTE 1:** \*td1 = delay time from input low-to-high transition to output transition. td2 = delay time from input high-to-low transition to output transition.

**POWER MANAGEMENT – Battery Chargers**

Part #	Mode	Cell Type	# of Cells	Vcc Range (V)	Cell Voltage (V)	Max. Charging Current (mA)	Max. Voltage Regulation (%)	Int/Ext FET	Features	Packages
MCP73826	Linear	Li-Ion/Li-Polymer	1	4.5 to 5.5	4.1, 4.2	N/A	±1.0	Ext	Small size, charge current set by external FET	6-Pin SOT-23
MCP73827	Linear	Li-Ion/Li-Polymer	1	4.5 to 5.5	4.1, 4.2	N/A	±1.0	Ext	Mode indicator, Charge Current monitor, charge current set by external FET	8-Pin MSOP
MCP73828	Linear	Li-Ion/Li-Polymer	1	4.5 to 5.5	4.1, 4.2	N/A	±1.0	Ext	Temperature monitor, charge current set by external FET	8-Pin MSOP
MCP73831	Linear	Li-Ion/Li-Polymer	1	3.7 to 6.0	4.2, 4.35, 4.4, 4.5	500	±0.75	Int	UVLO, Thermal regulation, Programmable charge current, tri-state STAT pin	5-Pin SOT-23, 8-Pin 2x3 DFN
MCP73832	Linear	Li-Ion/Li-Polymer	1	3.7 to 6.0	4.2, 4.35, 4.4, 4.5	500	±0.75	Int	UVLO, Thermal regulation, Programmable charge current, open-drain STAT pin	5-Pin SOT-23, 8-Pin 2x3 DFN
MCP73833	Linear	Li-Ion/Li-Polymer	1	3.7 to 6.0	4.2, 4.35, 4.4, 4.5	500	±0.75	Int	UVLO, Thermal regulation, Thermistor input, LDO Test mode, Multiple VREG outputs, Safety timer, Power Good output	10-Pin 3x3 DFN, 10-Pin MSOP
MCP73834	Linear	Li-Ion/Li-Polymer	1	3.7 to 6.0	4.2, 4.35, 4.4, 4.5	500	±0.75	Int	UVLO, Thermal regulation, Thermistor input, LDO Test mode, Multiple VREG outputs, Safety timer, Timer enable input	10-Pin 3x3 DFN, 10-Pin MSOP
MCP73841	Linear	Li-Ion/Li-Polymer	1	4.5 to 12	4.1, 4.2	N/A	±0.5	Ext	Safety charge timers, Temperature monitor, charge current set by external FET	10-Pin MSOP
MCP73842	Linear	Li-Ion/Li-Polymer	2	8.7 to 12	8.2, 8.4	N/A	±0.5	Ext	Safety charge timers, Temperature monitor, charge current set by external FET	10-Pin MSOP
MCP73843	Linear	Li-Ion/Li-Polymer	1	4.5 to 12	4.1, 4.2	N/A	±0.5	Ext	Safety charge timers, charge current set by external FET	8-Pin MSOP
MCP73844	Linear	Li-Ion/Li-Polymer	2	8.7 to 12	8.2, 8.4	N/A	±0.5	Ext	Safety charge timers, charge current set by external FET	8-Pin MSOP
MCP73853	Linear	Li-Ion/Li-Polymer	1	4.5 to 5.5	4.1, 4.2	500	±0.5	Int	USB control, Safety charge timers, Temperature monitor, Thermal regulation	16-Pin QFN (4x4)
MCP73855	Linear	Li-Ion/Li-Polymer	1	4.5 to 5.5	4.1, 4.2	500	±0.5	Int	USB control, Safety charge timers, Thermal regulation	10-Pin DFN (3x3)
MCP73861	Linear	Li-Ion/Li-Polymer	1	4.5 to 12	4.1, 4.2	1000	±0.5	Int	Safety charge timers, Temperature monitor, Thermal regulation, flashing STAT1 output on charge complete	16-Pin 4x4 QFN, 16-Pin SOIC
MCP73862	Linear	Li-Ion/Li-Polymer	2	8.7 to 12	8.2, 8.4	1000	±0.5	Int	Safety charge timers, Temperature monitor, Thermal regulation, hi-Z STAT1 output on charge complete	16-Pin 4x4 QFN, 16-Pin SOIC
MCP73863	Linear	Li-Ion/Li-Polymer	1	4.5 to 12	4.1, 4.2	1000	±0.5	Int	Safety charge timers, Temperature monitor, Thermal regulation, hi-Z STAT1 output on charge complete	16-Pin 4x4 QFN, 16-Pin SOIC
MCP73864	Linear	Li-Ion/Li-Polymer	2	8.7 to 12	8.2, 8.4	1000	±0.5	Int	Safety charge timers, Temperature monitor, Thermal regulation, hi-Z STAT1 output on charge complete	16-Pin 4x4 QFN, 16-Pin SOIC

**POWER MANAGEMENT – Hot Swap Controllers**

Part #	Number of Outputs	Vpos to Vneg Differential Voltage (V)	Junction Temperature Range (°C)	OVLO	UVLO	Power Good	Int/Ext FET	Applications	Packages
MCP18480	1	-0.3 to +15.0	-40 to +85	Adjustable	Adjustable	Adjustable	Ext	-48V Telecom/Datacom, Bus/Backplane	20-Pin SSOP

**LINEAR – Op Amps**

Part #	# per Package	GBWP	Iq Typical (µA)	Vos Max (mV)	Typical Input Leakage Current (pA)	Input Voltage Noise Density (nV/rtHz)	Operating Voltage (V)	Temp. Range (°C)	Features	Packages
TC1034	1	90 kHz	6	1.5	50	125 <sup>(1)</sup>	1.8 to 5.5	-40 to +85	Rail-to-Rail Input/Output	5-Pin SOT-23A <sup>(R)</sup>
TC1035	1	90 kHz	6	1.5	50	125 <sup>(1)</sup>	1.8 to 5.5	-40 to +85	Rail-to-Rail Input/Output, Shutdown pin	6-Pin SOT-23A <sup>(R)</sup>
TC1029	2	90 kHz	12	1.5	50	125 <sup>(1)</sup>	1.8 to 5.5	-40 to +85	Rail-to-Rail Input/Output	8-Pin PDIP, 8-Pin MSOP, 8-Pin SOIC
TC1030	4	90 kHz	5	1.5	50	125 <sup>(1)</sup>	1.8 to 5.5	-40 to +85	Rail-to-Rail Input/Output, Shutdown pins	16-Pin QSOP
MCP6041	1	14 kHz	0.6	3	1	170 <sup>(1)</sup>	1.4 to 5.5	-40 to +85	Rail-to-Rail Input/Output	8-Pin PDIP, 8-Pin SOIC, 8-Pin MSOP, 5-Pin SOT-23 <sup>(S)</sup>
MCP6042	2	14 kHz	0.6	3	1	170 <sup>(1)</sup>	1.4 to 5.5	-40 to +85	Rail-to-Rail Input/Output	8-Pin PDIP, 8-Pin SOIC, 8-Pin MSOP
MCP6043	1	14 kHz	0.6	3	1	170 <sup>(1)</sup>	1.4 to 5.5	-40 to +85	Rail-to-Rail Input/Output, Chip Select	8-Pin PDIP, 8-Pin SOIC, 8-Pin MSOP
MCP6044	4	14 kHz	0.6	3	1	170 <sup>(1)</sup>	1.4 to 5.5	-40 to +85	Rail-to-Rail Input/Output	14-Pin PDIP, 14-Pin SOIC, 14-Pin TSSOP
MCP6141	1	100 kHz	0.6	3	1	170 <sup>(1)</sup>	1.4 to 5.5	-40 to +85	Rail-to-Rail Input/Output, G>10 stable	5-Pin SOT-23 <sup>(S)</sup> , 8-Pin PDIP, 8-Pin SOIC, 8-Pin MSOP
MCP6142	2	100 kHz	0.6	3	1	170 <sup>(1)</sup>	1.4 to 5.5	-40 to +125	Rail-to-Rail Input/Output, G>10 stable	8-Pin PDIP, 8-Pin SOIC, 8-Pin MSOP
MCP6143	1	100 kHz	0.6	3	1	170 <sup>(1)</sup>	1.4 to 5.5	-40 to +125	Rail-to-Rail Input/Output, G>10 stable, Chip Select	6-Pin SOT-23 <sup>(S)</sup> , 8-Pin PDIP, 8-Pin SOIC, 8-Pin MSOP
MCP6144	4	100 kHz	0.6	3	1	170 <sup>(1)</sup>	1.4 to 5.5	-40 to +125	Rail-to-Rail Input/Output, G>10 stable	14-Pin PDIP, 14-Pin SOIC, 14-Pin TSSOP
MCP606	1	155 kHz	19	0.25	1	38 <sup>(1)</sup>	2.5 to 5.5	-40 to +125	Rail-to-Rail Output	8-Pin PDIP, 8-Pin SOIC, 8-Pin TSSOP, 5-Pin SOT23 <sup>(S)</sup>
MCP607	2	155 kHz	19	0.25	1	38 <sup>(1)</sup>	2.5 to 5.5	-40 to +85	Rail-to-Rail Output	8-Pin PDIP, 8-Pin SOIC, 8-Pin TSSOP
MCP608	1	155 kHz	19	0.25	1	38 <sup>(1)</sup>	2.5 to 5.5	-40 to +85	Rail-to-Rail Output, Chip Select	8-Pin PDIP, 8-Pin SOIC, 8-Pin TSSOP
MCP609	4	155 kHz	19	0.25	1	38 <sup>(1)</sup>	2.5 to 5.5	-40 to +85	Rail-to-Rail Output	14-Pin PDIP, 14-Pin SOIC, 14-Pin TSSOP
MCP616	1	190 kHz	19	0.15	15000	32 <sup>(1)</sup>	2.3 to 5.5	-40 to +85	Rail-to-Rail Output, PNP Input	8-Pin PDIP, 8-Pin SOIC, 8-Pin MSOP
MCP617	2	190 kHz	19	0.15	15000	32 <sup>(1)</sup>	2.3 to 5.5	-40 to +85	Rail-to-Rail Output, PNP	8-Pin PDIP, 8-Pin SOIC, 8-Pin MSOP
MCP618	1	190 kHz	19	0.15	15000	32 <sup>(1)</sup>	2.3 to 5.5	-40 to +85	Rail-to-Rail Output, Chip Select, PNP Input	8-Pin PDIP, 8-Pin SOIC, 8-Pin MSOP

Legend: S = Standard Pinout; R = Reverse Pinout; U = Alternative Pinout

NOTE 1: Values are typical at 1 kHz

2: Values are typical at 10 kHz

**LINEAR – Op Amps (continued)**

Part #	# per Package	GBWP	I <sub>Q</sub> Typical (μA)	V <sub>OS</sub> Max (mV)	Typical Input Leakage Current (pA)	Input Voltage Noise Density (nV/rtHz)	Operating Voltage (V)	Temp. Range (°C)	Features	Packages
MCP619	4	190 kHz	19	0.15	15000	32 <sup>(1)</sup>	2.3 to 5.5	-40 to +85	Rail-to-Rail Output, PNP Input	14-Pin PDIP, 14-Pin SOIC, 14-Pin TSSOP
MCP6231	1	300 kHz	20	5	1	52 <sup>(1)</sup>	1.8 to 5.5	-40 to +125	Rail-to-Rail Input/Output	5-Pin SC-70 <sup>(U)</sup> , 5-Pin SOT-23 <sup>(S,R,U)</sup> , 8-Pin PDIP, 8-Pin SOIC, 8-Pin MSOP
MCP6232	2	300 kHz	20	5	1	52 <sup>(1)</sup>	1.8 to 5.5	-40 to +125	Rail-to-Rail Input/Output	8-Pin PDIP, 8-Pin SOIC, 8-Pin MSOP
MCP6234	4	300 kHz	20	5	1	52 <sup>(1)</sup>	1.8 to 5.5	-40 to +125	Rail-to-Rail Input/Output	14-Pin PDIP, 14-Pin SOIC, 14-Pin TSSOP
MCP6241	1	550 kHz	50	5	1	45 <sup>(1)</sup>	1.8 to 5.5	-40 to +125	Rail-to-Rail Input/Output	5-Pin SC-70 <sup>(U)</sup> , 5-Pin SOT-23 <sup>(S,R,U)</sup> , 8-Pin PDIP, 8-Pin SOIC, 8-Pin MSOP
MCP6242	2	550 kHz	50	5	1	45 <sup>(1)</sup>	1.8 to 5.5	-40 to +125	Rail-to-Rail Input/Output	8-Pin PDIP, 8-Pin SOIC, 8-Pin MSOP
MCP6244	4	550 kHz	50	5	1	45 <sup>(1)</sup>	1.8 to 5.5	-40 to +125	Rail-to-Rail Input/Output	14-Pin PDIP, 14-Pin SOIC, 14-Pin TSSOP
MCP6001	1	1 MHz	140	4.5	1	28 <sup>(1)</sup>	1.8 to 5.5	-40 to +125	Rail-to-Rail Input/Output	5-Pin SOT-23 <sup>(S,R,U)</sup> , 5-Pin SC-70 <sup>(R,U)</sup>
MCP6002	2	1 MHz	140	4.5	1	28 <sup>(1)</sup>	1.8 to 5.5	-40 to +125	Rail-to-Rail Input/Output	8-Pin PDIP, 8-Pin SOIC, 8-Pin MSOP
MCP6004	4	1 MHz	140	4.5	1	28 <sup>(1)</sup>	1.8 to 5.5	-40 to +125	Rail-to-Rail Input/Output	14-Pin PDIP, 14-Pin SOIC, 14-Pin TSSOP
MCP6271	1	2 MHz	170	3	1	20 <sup>(1)</sup>	2.0 to 5.5	-40 to +125	Rail-to-Rail Input/Output	5-Pin SOT-23 <sup>(S,R)</sup> , 8-Pin PDIP, 8-Pin SOIC, 8-Pin MSOP
MCP6272	2	2 MHz	170	3	1	20 <sup>(1)</sup>	2.0 to 5.5	-40 to +125	Rail-to-Rail Input/Output	8-Pin PDIP, 8-Pin SOIC, 8-Pin MSOP
MCP6273	1	2 MHz	170	3	1	20 <sup>(1)</sup>	2.0 to 5.5	-40 to +125	Rail-to-Rail Input/Output, Chip Select	6-Pin SOT-23 <sup>(S)</sup> , 8-Pin PDIP, 8-Pin SOIC, 8-Pin MSOP
MCP6274	4	2 MHz	170	3	1	20 <sup>(1)</sup>	2.0 to 5.5	-40 to +125	Rail-to-Rail Input/Output	14-Pin PDIP, 14-Pin SOIC, 14-Pin TSSOP
MCP6275	2	2 MHz	150	3	1	20 <sup>(1)</sup>	2.0 to 5.5	-40 to +125	Rail-to-Rail Input/Output, Dual connected, Chip Select	8-Pin PDIP, 8-Pin SOIC, 8-Pin MSOP
MCP601	1	2.8 MHz	230	2	1	29 <sup>(1)</sup>	2.7 to 5.5	-40 to +125	Rail-to-Rail Output	5-Pin SOT-23 <sup>(S,R)</sup> , 8-Pin PDIP, 8-Pin SOIC, 8-Pin TSSOP
MCP602	2	2.8 MHz	230	2	1	29 <sup>(1)</sup>	2.7 to 5.5	-40 to +125	Rail-to-Rail Output	8-Pin PDIP, 8-Pin SOIC, 8-Pin TSSOP
MCP603	1	2.8 MHz	230	2	1	29 <sup>(1)</sup>	2.7 to 5.5	-40 to +125	Rail-to-Rail Output, Chip Select	6-Pin SOT-23 <sup>(S)</sup> , 8-Pin PDIP, 8-Pin SOIC, 8-Pin TSSOP
MCP604	4	2.8 MHz	230	2	1	29 <sup>(1)</sup>	2.7 to 5.5	-40 to +125	Rail-to-Rail Output	14-Pin PDIP, 14-Pin SOIC, 14-Pin TSSOP
MCP6281	1	5 MHz	445	3	1	16 <sup>(1)</sup>	2.2 to 5.5	-40 to +125	Rail-to-Rail Input/Output	5-Pin SOT-23 <sup>(S,R)</sup> , 8-Pin PDIP, 8-Pin SOIC, 8-Pin MSOP
MCP6282	2	5 MHz	445	3	1	16 <sup>(1)</sup>	2.2 to 5.5	-40 to +125	Rail-to-Rail Input/Output	8-Pin PDIP, 8-Pin SOIC, 8-Pin MSOP
MCP6283	1	5 MHz	445	3	1	16 <sup>(1)</sup>	2.2 to 5.5	-40 to +125	Rail-to-Rail Input/Output, Chip Select	6-Pin SOT-23 <sup>(S,R)</sup> , 8-Pin PDIP, 8-Pin SOIC, 8-Pin MSOP
MCP6284	4	5 MHz	445	3	1	16 <sup>(1)</sup>	2.2 to 5.5	-40 to +125	Rail-to-Rail Input/Output	14-Pin PDIP, 14-Pin SOIC, 14-Pin TSSOP

Legend: S = Standard Pinout; R = Reverse Pinout; U = Alternative Pinout

NOTE 1: Values are typical at 1 kHz

2: Values are typical at 10 kHz

### LINEAR – Op Amps (continued)

Part #	# per Package	GBWP	I <sub>Q</sub> Typical (μA)	I <sub>Q</sub> Max (mA)	V <sub>OS</sub> Max (mV)	Typical Input Leakage Current (pA)	Input Voltage Noise Density (nV/√Hz)	Operating Voltage (V)	Temp. Range (°C)	Features	Packages
MCP6285	2	5 MHz	400	3	3	1	16 <sup>(1)</sup>	2.2 to 5.5	-40 to +125	Rail-to-Rail Input/Output, Dual connected, Chip Select	8-Pin PDIP, 8-Pin SOIC, 8-Pin MSOP
MCP6291	1	10 MHz	1000	3	3	1	8.7 <sup>(2)</sup>	2.4 to 5.5	-40 to +125	Rail-to-Rail Input/Output	5-Pin SOT-23 <sup>(S,R)</sup> , 8-Pin PDIP, 8-Pin SOIC, 8-Pin MSOP
MCP6292	2	10 MHz	1000	3	3	1	8.7 <sup>(2)</sup>	2.4 to 5.5	-40 to +125	Rail-to-Rail Input/Output	8-Pin PDIP, 8-Pin SOIC, 8-Pin MSOP
MCP6293	1	10 MHz	1000	3	3	1	8.7 <sup>(2)</sup>	2.4 to 5.5	-40 to +125	Rail-to-Rail Input/Output, Chip Select	6-Pin SOT-23 <sup>(S)</sup> , 8-Pin PDIP, 8-Pin SOIC, 8-Pin MSOP
MCP6294	4	10 MHz	1000	3	3	1	8.7 <sup>(2)</sup>	2.4 to 5.5	-40 to +125	Rail-to-Rail Input/Output	14-Pin PDIP, 14-Pin SOIC, 14-Pin TSSOP
MCP6295	2	10 MHz	1100	3	3	1	8.7 <sup>(2)</sup>	2.4 to 5.5	-40 to +125	Rail-to-Rail Input/Output, Dual connected, Chip Select	8-Pin PDIP, 8-Pin SOIC, 8-Pin MSOP
MCP6021	1	10 MHz	1000	0.5	0.5	1	8.7 <sup>(2)</sup>	2.5 to 5.5	-40 to +125	Rail-to-Rail Input/Output, 1/2 V <sub>CC</sub> V <sub>REF</sub>	5-Pin SOT-23 <sup>(S,R)</sup> , 8-Pin PDIP, 8-Pin SOIC, 8-Pin TSSOP, 8-Pin MSOP
MCP6022	2	10 MHz	1000	0.5	0.5	1	8.7 <sup>(2)</sup>	2.5 to 5.5	-40 to +125	Rail-to-Rail Input/Output	8-Pin PDIP, 8-Pin SOIC, 8-Pin TSSOP
MCP6023	1	10 MHz	1000	0.5	0.5	1	8.7 <sup>(2)</sup>	2.5 to 5.5	-40 to +125	Rail-to-Rail Input/Output, Chip Select, 1/2 V <sub>CC</sub> V <sub>REF</sub>	8-Pin PDIP, 8-Pin SOIC, 8-Pin TSSOP
MCP6024	4	10 MHz	1000	0.5	0.5	1	8.7 <sup>(2)</sup>	2.5 to 5.5	-40 to +125	Rail-to-Rail Input/Output	14-Pin PDIP, 14-Pin SOIC, 14-Pin TSSOP

Legend: S = Standard Pinout; R = Reverse Pinout; U = Alternative Pinout

NOTE 1: Values are typical at 1 kHz

2: Values are typical at 10 kHz

### LINEAR – High Precision Operational Amplifiers

Part #	# per Package	GBWP	I <sub>Q</sub> Max (mA)	Typical V <sub>OS</sub> (μV)	V <sub>OS</sub> Drift Max (μV/°C)	Operating Voltage (V)	Temp. Range (°C)	Features	Packages
Chopper Stabilized									
TC7650	1	2.0 MHz	3.5	5	0.05	4.5 to 16	0 to 70	Single and Split Supply	8-Pin PDIP, 14-Pin PDIP
TC7652	1	0.4 MHz	3	5	0.05	5 to 16	0 to 70	Single and Split Supply, Low Noise	8-Pin PDIP, 14-Pin PDIP
Auto-Zero									
TC913A/B	2	1.5 MHz	1.1	15	0.15/0.30	6.5 to 16	0 to 70	Single and Split Supply	8-Pin PDIP, 8-Pin SOIC

### LINEAR – Programmable Gain Amplifiers (PGA)

Part #	Channels	-3dB BW (MHz)	I <sub>Q</sub> Typ.	V <sub>OS</sub> (μV)	Operating Voltage (V)	Temp. Range (°C)	Features	Packages
MCP6S21	1	2 to 12	1.1 mA	275	2.5 to 5.5	-40 to +85	SPI, 8 Gain Steps, Software Shutdown	8-Pin PDIP, 8-Pin SOIC, 8-Pin MSOP
MCP6S22	2	2 to 12	1.1 mA	275	2.5 to 5.5	-40 to +85	SPI, 8 Gain Steps, Software Shutdown	8-Pin PDIP, 8-Pin SOIC, 8-Pin MSOP
MCP6S26	6	2 to 12	1.1 mA	275	2.5 to 5.5	-40 to +85	SPI, 8 Gain Steps, Software Shutdown	14-Pin PDIP, 14-Pin SOIC, 14-Pin TSSOP
MCP6S28	8	2 to 12	1.1 mA	275	2.5 to 5.5	-40 to +85	SPI, 8 Gain Steps, Software Shutdown	16-Pin PDIP, 16-Pin SOIC
MCP6S91	1	1 to 18	1.0 mA	4000	2.5 to 5.5	-40 to +125	SPI, 8 Gain Steps, Software Shutdown, V <sub>REF</sub>	8-Pin PDIP, 8-Pin SSOIC, 8-Pin MSOP

**LINEAR – Programmable Gain Amplifiers (PGA) (continued)**

Part #	Channels	-3dB BW (MHz)	I <sub>o</sub> Typ.	V <sub>os</sub> (μV)	Operating Voltage (V)	Temp. Range (°C)	Features	Packages
MCP6S92	2	1 to 18	1.0 mA	4000	2.5 to 5.5	-40 to +125	SPI, 8 Gain Steps, Software Shutdown	8-Pin PDIP, 8-Pin SSOIC, 8-Pin MSOP
MCP6S93	2	1 to 18	1.0 mA	4000	2.5 to 5.5	-40 to +125	SPI, 8 Gain Steps, Software Shutdown, V <sub>REF</sub> , SO	10-Pin MSOP

**LINEAR – Integrated Devices**

Part #	# of Op Amps per Package	# of Comparators per Package	I <sub>o</sub> Typical (μA)	V <sub>REF</sub> (V)	Operating Voltage (V)	Temp. Range (°C)	Features	Packages
TC1026C	1	1	12	1.2	1.8 to 5.5	-40 to +85	On-board V <sub>REF</sub>	8-Pin PDIP, 8-Pin MSOP, 8-Pin SOIC
TC1043C	2	2	16	1.2	1.8 to 5.5	-40 to +85	On-board V <sub>REF</sub> , Shutdown pin	16-Pin QSOP

**LINEAR – Comparators**

Part #	# per Package	V <sub>REF</sub> (V)	Typical Propagation Delay (μs)	I <sub>o</sub> Typical (μA)	V <sub>os</sub> Max (mV)	Operating Voltage (V)	Temp. Range (°C)	Features	Packages
TC1027	4	1.2	4	18	5	1.8 to 5.5	-40 to +85	On-board V <sub>REF</sub> , Rail-to-Rail Input/Output	16-Pin PDIP, 16-Pin QSOP, 16-Pin SOIC
TC1037	1	—	4	4	5	1.8 to 5.5	-40 to +85	Rail-to-Rail Input/Output	5-Pin SOT-23A(S)
TC1038	1	—	4	4	5	1.8 to 5.5	-40 to +85	Shutdown pin, Rail-to-Rail Input/Output	6-Pin SOT-23A(S)
TC1039	1	1.2	4	6	5	1.8 to 5.5	-40 to +85	On-board V <sub>REF</sub> , Rail-to-Rail Input/Output	6-Pin SOT-23A(S)
TC1041	2	1.2	4	10	5	1.8 to 5.5	-40 to +85	On-board V <sub>REF</sub> , Programmable hysteresis, Rail-to-Rail Input/Output	8-Pin MSOP, 8-Pin SOIC
MCP6541	1	—	4	1	5	1.6 to 5.5	-40 to +85	Push-Pull, Rail-to-Rail Input/Output	5-Pin SOT-23(S,R), 5-Pin SC-70(S), 8-Pin PDIP, 8-Pin SOIC, 8-Pin MSOP
MCP6542	2	—	4	1	5	1.6 to 5.5	-40 to +85	Push-Pull, Rail-to-Rail Input/Output	8-Pin PDIP, 8-Pin SOIC, 8-Pin MSOP
MCP6543	1	—	4	1	5	1.6 to 5.5	-40 to +85	Push-Pull, Rail-to-Rail Input/Output, Chip Select	8-Pin PDIP, 8-Pin SOIC, 8-Pin MSOP
MCP6544	4	—	4	1	5	1.6 to 5.5	-40 to +85	Push-Pull, Rail-to-Rail Input/Output	8-Pin PDIP, 8-Pin SOIC, 8-Pin MSOP
MCP6546	1	—	4	1	5	1.6 to 5.5	-40 to +85	Open-drain, 9V, Rail-to-Rail Input/Output	14-Pin PDIP, 14-Pin SOIC, 14-Pin TSSOP
MCP6547	2	—	4	1	5	1.6 to 5.5	-40 to +85	Open-drain, 9V, Rail-to-Rail Input/Output	5-Pin SOT-23(S,R), 5-Pin SC-70(S), 8-Pin PDIP, 8-Pin SOIC, 8-Pin MSOP
MCP6548	1	—	4	1	5	1.6 to 5.5	-40 to +85	Open-drain, 9V, Rail-to-Rail Input/Output, Chip Select	8-Pin PDIP, 8-Pin SOIC, 8-Pin MSOP
MCP6549	4	—	4	1	5	1.6 to 5.5	-40 to +85	Open-drain, 9V, Rail-to-Rail Input/Output	8-Pin PDIP, 8-Pin SOIC, 8-Pin MSOP

Legend: S = Standard Pinout; R = Reverse Pinout

**MIXED SIGNAL – Successive Approximation Register (SAR) A/D Converters**

Part #	Resolution (bits)	Maximum Sampling Rate (ksamples/sec)	# of Input Channels	Input Type	Interface	Input Voltage Range (V)	Max. Supply Current (μA)	Max. INL	Temp. Range (°C)	Packages
MCP3021	10	22	1	Single-ended	I <sup>2</sup> C™	2.7 to 5.5	250	±1 LSB	-40 to +125	5-Pin SOT-23A
MCP3001	10	200	1	Single-ended	SPI	2.7 to 5.5	500	±1 LSB	-40 to +85	8-Pin PDIP, 8-Pin SOIC, 8-Pin TSSOP

**MIXED SIGNAL – Successive Approximation Register (SAR) A/D Converters (continued)**

Part #	Resolution (bits)	Maximum Sampling Rate (ksamples/sec)	# of Input Channels	Input Type	Interface	Input Voltage Range (V)	Max. Supply Current (µA)	Max. INL	Temp. Range (°C)	Packages
MCP3002	10	200	2	Single-ended	SPI	2.7 to 5.5	650	±1 LSB	-40 to +85	8-Pin PDIP, 8-Pin SOIC, 8-Pin TSSOP
MCP3004	10	200	4	Single-ended	SPI	2.7 to 5.5	550	±1 LSB	-40 to +85	14-Pin PDIP, 14-Pin SOIC, 14-Pin TSSOP
MCP3008	10	200	8	Single-ended	SPI	2.7 to 5.5	550	±1 LSB	-40 to +85	16-Pin PDIP, 16-Pin SOIC
MCP3221	12	22	1	Single-ended	I <sup>2</sup> C™	2.7 to 5.5	250	±2 LSB	-40 to +125	5-Pin SOT-23A
MCP3201	12	100	1	Single-ended	SPI	2.7 to 5.5	400	±1 LSB	-40 to +85	8-Pin PDIP, 8-Pin SOIC, 8-Pin TSSOP
MCP3202	12	100	2	Single-ended	SPI	2.7 to 5.5	550	±1 LSB	-40 to +85	8-Pin PDIP, 8-Pin SOIC, 8-Pin TSSOP
MCP3204	12	100	4	Single-ended	SPI	2.7 to 5.5	400	±1 LSB	-40 to +85	14-Pin PDIP, 14-Pin SOIC, 14-Pin TSSOP
MCP3208	12	100	8	Single-ended	SPI	2.7 to 5.5	400	±1 LSB	-40 to +85	16-Pin PDIP, 16-Pin SOIC
MCP3301	13	100	1	Differential	SPI	2.7 to 5.5	450	±1 LSB	-40 to +85	8-Pin PDIP, 8-Pin SOIC, 8-Pin MSOP
MCP3302	13	100	2	Differential	SPI	2.7 to 5.5	450	±1 LSB	-40 to +85	14-Pin PDIP, 14-Pin SOIC, 14-Pin TSSOP
MCP3304	13	100	4	Differential	SPI	2.7 to 5.5	450	±1 LSB	-40 to +85	16-Pin PDIP, 16-Pin SOIC

**MIXED SIGNAL – Delta-Sigma A/D Converters**

Part #	Resolution (bits)	Maximum Sampling Rate (samples/sec)	# of Input Channels	Interface	Supply Voltage Range (V)	Typical Supply Current (µA)	Typical INL (ppm)	Temp. Range (°C)	Features	Packages
MCP3550-50	22	13	1 Diff	SPI	2.7 to 5.5	120	2	-40 to +125	50 Hz rejection	8-Pin SOIC, 8-Pin MSOP
MCP3550-60	22	15	1 Diff	SPI	2.7 to 5.5	140	2	-40 to +125	60 Hz rejection	8-Pin SOIC, 8-Pin MSOP
MCP3551	22	14	1 Diff	SPI	2.7 to 5.5	120	2	-40 to +125	Simultaneous 50/60 Hz rejection	8-Pin SOIC, 8-Pin MSOP
MCP3553	20	60	1 Diff	SPI	2.7 to 5.5	140	2	-40 to +125		8-Pin SOIC, 8-Pin MSOP
TC3400(1)	10 to 16	>400	1 Diff	2-Wire	1.8 to 5.5	260	38	0 to +85		8-Pin PDIP, 8-Pin SOIC
TC3401(1)	10 to 16	>400	2 Diff	2-Wire	1.8 to 5.5	300	38	0 to +85	Enable mode, Reset monitor, Power-fail monitor	16-Pin PDIP, 16-Pin QSOP
TC3402(1)	10 to 16	>400	4 Diff	2-Wire	1.8 to 5.5	250	38	0 to +85		16-Pin PDIP, 16-Pin QSOP
TC3405(1)	10 to 16	>400	3 Single-ended, 1 Diff	2-Wire	1.8 to 5.5	250	38	0 to +85	Enable mode, Reset monitor	16-Pin PDIP, 16-Pin QSOP

NOTE 1: All TC340X are not recommended for new designs.

**MIXED SIGNAL – Energy Measurement ICs**

Part #	Dynamic Measurement	Typical Measurement Accuracy	Gain	Typical Voltage Reference Drift	Typical Supply Current	Supply Voltage Range (V)	Temp. Range (°C)	Features	Packages
MCP3905	500:1	0.1%	1, 2, 8, 16	15 ppm	AIDD - 2 mA DIDD - 15 mA	4.5 to 5.5	-40 to +85	Active (real) power pulse output	24-Pin SSOP
MCP3906	1000:1	0.1%	1, 2, 16, 32	15 ppm	AIDD - 2 mA DIDD - 15 mA	4.5 to 5.5	-40 to +85	Active (real) power pulse output	24-Pin SSOP

**MIXED SIGNAL – Dual Slope A/D Converters**

Part #	Supply Voltage (V)	Input Voltage Range (V)	Resolution	Sampling Rate (Conv/s)	Input Channels	Data Interface	Temp. Range (°C)	Features	Packages
TC500	±4.5 to ±7.5	V <sub>SS</sub> + 1.5V to V <sub>DD</sub> – 1.5V	Up to 16 bits	4 to 10	1	3-Wire	0 to +70	Differential input range, Programmable resolution/conversion time	16-Pin PDIP, 16-Pin SOIC, 16-Pin CerDIP
TC500A	±4.5 to ±7.5	V <sub>SS</sub> + 1.5V to V <sub>DD</sub> – 1.5V	Up to 17 bits	4 to 10	1	3-Wire	0 to +70	Differential input range, Programmable resolution/conversion time	16-Pin PDIP, 16-Pin SOIC, 16-Pin CerDIP
TC510	±4.5 to ±5.5	V <sub>SS</sub> + 1.5V to V <sub>DD</sub> – 1.5V	Up to 17 bits	4 to 10	1	3-Wire	0 to +70	Differential input range, Programmable resolution/conversion time, Charge pump (-V) output pin	24-Pin PDIP, 24-Pin SOIC
TC514	±4.5 to ±5.5	V <sub>SS</sub> + 1.5V to V <sub>DD</sub> – 1.5V	Up to 17 bits	4 to 10	4	3-Wire	0 to +70	Differential input range, Programmable resolution/conversion time, Charge pump (-V) output pin	28-Pin PDIP, 28-Pin SOIC
TC520A	±4.5 to ±5.5	—	—	—	—	Serial port	0 to +70	Optional serial interface adapter for TC500/500A/510/514	14-Pin PDIP, 16-Pin SOIC
TC530	±4.5 to ±5.5	V <sub>SS</sub> + 1.5V to V <sub>DD</sub> – 1.5V	Up to 17 bits	3 to 10	1	Serial port	0 to +70	Differential input range, Programmable resolution/conversion time, Charge pump (-V) output pin	28-Pin PDIP, 28-Pin SOIC
TC534	±4.5 to ±5.5	V <sub>SS</sub> + 1.5V to V <sub>DD</sub> – 1.5V	Up to 17 bits	3 to 10	4	Serial port	0 to +70	Differential input range, Programmable resolution/conversion time, Charge pump (-V) output pin	40-Pin PDIP, 44-Pin MQFP
TC7109	±4.5 to ±5.5	V <sub>SS</sub> + 1.5V to V <sub>DD</sub> – 1.0V	12 bits plus sign bit	2 to 10	1	Parallel or Serial port	-25 to +85	Differential input range	40-Pin PDIP, 40-Pin CerDip, 44-Pin PLCC, 44-Pin MQFP
TC7109A	±4.5 to ±5.5	V <sub>SS</sub> + 1.5V to V <sub>DD</sub> – 1.0V	12 bits plus sign bit	2 to 10	1	Parallel or Serial port	-25 to +85	Differential input range	40-Pin PDIP, 40-Pin CerDip, 44-Pin PLCC, 44-Pin MQFP

**MIXED SIGNAL – Binary and BCD A/D Converters**

Part #	Description	Supply Voltage (V)	Input Voltage Range (V)	Resolution (Digits)	Resolution (Counts)	Max Power (mW)	Data Interface	Temp. Range (°C)	Features	Packages
TC835	BCD A/D	±5	V <sub>SS</sub> + 1.0V to V <sub>DD</sub> – 0.5V	4½	±20,000	30	MUXed BCD	0 to +70	Upgrade to TC7135	64-Pin MQFP, 44-Pin MQFP, 28-Pin PDIP
TC850	Binary A/D	±5	V <sub>SS</sub> + 1.5V to V <sub>DD</sub> – 1.5V	15-bit	±32,768	35	8-bit parallel	-25 to +70	Highest conversion speed (40 conv/sec)	44-Pin PLCC, 40-Pin PDIP, 40-Pin CerDIP
TC7135	BCD A/D	±5	V <sub>SS</sub> + 1.0V to V <sub>DD</sub> – 1.0V	4½	±20,000	30	MUXed BCD	0 to +70	For DMM, DPM, Data loggers	28-Pin PLCC, 28-Pin PDIP, 64-Pin MQFP
TC14433	BCD A/D	±4.5 to ±8	±199.9 mV to 1.999V	3½	±2,000	20	MUXed BCD	-40 to +85	For DMM, DPM, Data loggers	24-Pin SOIC, 24-Pin PDIP, 28-Pin PLCC, 24-Pin CerDIP
TC14433A	BCD A/D	±4.5 to ±8	±199.9 mV to 1.999V	3½	±2,000	20	MUXed BCD	-40 to +85	For DMM, DPM, Data loggers	24-Pin PDIP, 28-Pin PLCC, 24-Pin CerDIP

**MIXED SIGNAL – Display A/D Converters**

Part #	Display Type	Supply Voltage (V)	Resolution (Digits)	Resolution (Counts)	Power (mW)	Temp. Range (°C)	Features	Packages
TC820	LCD	9	3½	±4,000	10	0 to +70	DMM plus frequency counter and logic probe	40-Pin PDIP, 44-Pin PLCC, 44-Pin MQFP
TC7106	LCD	9	3½	±2,000	10	-25 to +85	For DMM, DPM, Data logger applications	40-Pin PDIP, 44-Pin PLCC, 44-Pin MQFP, 40-Pin CerDIP
TC7106A	LCD	9	3½	±2,000	10	-25 to +85	For DMM, DPM, Data logger applications	40-Pin PDIP, 44-Pin PLCC, 44-Pin MQFP, 40-Pin CerDIP
TC7107	LED	±5	3½	±2,000	10	-25 to +85	For DMM, DPM, Data logger applications	40-Pin PDIP, 44-Pin PLCC, 44-Pin MQFP, 40-Pin CerDIP
TC7107A	LED	±5	3½	±2,000	10	-25 to +85	For DMM, DPM, Data logger applications	40-Pin PDIP, 44-Pin PLCC, 44-Pin MQFP, 40-Pin CerDIP



**MIXED SIGNAL – Display A/D Converters (continued)**

Part #	Display Type	Supply Voltage (V)	Resolution (Digits)	Resolution (Counts)	Power (mW)	Temp. Range (°C)	Features	Packages
TC7116	LCD	9	3½	±2,000	10	-25 to +85	Hold function	40-Pin PDIP, 44-Pin PLCC, 44-Pin MQFP, 40-Pin CerDIP
TC7116A	LCD	9	3½	±2,000	10	-25 to +85	Hold function	40-Pin PDIP, 44-Pin PLCC, 44-Pin MQFP, 40-Pin CerDIP
TC7117	LED	±5	3½	±2,000	10	-25 to +85	Hold function	40-Pin PDIP, 44-Pin PLCC, 44-Pin MQFP, 40-Pin CerDIP
TC7117A	LED	±5	3½	±2,000	10	-25 to +85	Hold function	40-Pin PDIP, 44-Pin PLCC, 44-Pin MQFP, 40-Pin CerDIP
TC7126	LCD	9	3½	±2,000	0.5	-25 to +85	Low-power TC7106	40-Pin PDIP, 44-Pin PLCC, 44-Pin MQFP, 40-Pin CerDIP
TC7126A	LCD	9	3½	±2,000	0.5	-25 to +85	Low-power TC7106	40-Pin PDIP, 44-Pin PLCC, 44-Pin MQFP, 40-Pin CerDIP
TC7129	LCD	9	4½	±20,000	4.5	0 to +70	Lowest noise ±3 mV sensitivity	40-Pin PDIP, 44-Pin PLCC, 44-Pin MQFP

**MIXED SIGNAL – Digital Potentiometers**

Part #	Number of Taps	Memory	Number per Package	Interface	Resistance (kOhms)	INL (max)	DNL (max)	Temp. Range (°C)	Comments	Packages
MCP4011	64	Volatile	1	Up/Down	2.1, 5, 10, 50	0.5	0.5	-40 to +125	Potentiometer mode	8-Pin SOIC, 8-Pin MSOP, 8-Pin 2X3 DFN
MCP4012	64	Volatile	1	Up/Down	2.1, 5, 10, 50	0.5	0.5	-40 to +125	Rheostat mode	6-Pin SOT-23
MCP4013	64	Volatile	1	Up/Down	2.1, 5, 10, 50	0.5	0.5	-40 to +125	Potentiometer to Vss	6-Pin SOT-23
MCP4014	64	Volatile	1	Up/Down	2.1, 5, 10, 50	0.5	0.5	-40 to +125	Rheostat to Vss	5-Pin SOT-23
MCP4021	64	Nonvolatile	1	Up/Down	2.1, 5, 10, 50	0.5	0.5	-40 to +125	Potentiometer mode, Shutdown, WiperLock™ Technology	8-Pin SOIC, 8-Pin MSOP, 8-Pin 2X3 DFN
MCP4022	64	Nonvolatile	1	Up/Down	2.1, 5, 10, 50	0.5	0.5	-40 to +125	Rheostat mode, Shutdown, WiperLock™ Technology	6-Pin SOT-23
MCP4023	64	Nonvolatile	1	Up/Down	2.1, 5, 10, 50	0.5	0.5	-40 to +125	Potentiometer to Vss, WiperLock™ Technology	6-Pin SOT-23
MCP4024	64	Nonvolatile	1	Up/Down	2.1, 5, 10, 50	0.5	0.5	-40 to +125	Rheostat to Vss, Shutdown, WiperLock™ Technology	5-Pin SOT-23
MCP41010	256	Volatile	1	SPI	10	1	1	-40 to +85	Potentiometer mode, Shutdown	8-Pin PDIP, 8-Pin SOIC
MCP41050	256	Volatile	1	SPI	50	1	1	-40 to +85	Potentiometer mode, Shutdown	8-Pin PDIP, 8-Pin SOIC
MCP41100	256	Volatile	1	SPI	100	1	1	-40 to +85	Potentiometer mode, Shutdown	8-Pin PDIP, 8-Pin SOIC
MCP42010	256	Volatile	2	SPI	10	1	1	-40 to +85	Potentiometer mode, Shutdown	14-Pin PDIP, 14-Pin SOIC, 14-Pin TSSOP
MCP42050	256	Volatile	2	SPI	50	1	1	-40 to +85	Potentiometer mode, Shutdown	14-Pin PDIP, 14-Pin SOIC, 14-Pin TSSOP
MCP42100	256	Volatile	2	SPI	100	1	1	-40 to +85	Potentiometer mode, Shutdown	14-Pin PDIP, 14-Pin SOIC, 14-Pin TSSOP

**MIXED SIGNAL – Frequency-to-Voltage/Voltage-to-Frequency Converters**

Part #	Frequency Range (kHz)	Full Scale (ppm FS/°C)	Non-linearity (%FS)	Temp. Range (°C)	Packages
TC9400	100	±40	±0.05	-40 to +85	14-Pin PDIP, 14-Pin SOIC
TC9401	100	±40	±0.02	-40 to +85	14-Pin PDIP, 14-Pin SOIC
TC9402	100	±100	±0.25	-40 to +85	14-Pin PDIP, 14-Pin SOIC

**MIXED SIGNAL – D/A Converters**

Part #	Resolution (Bits)	DACs per Package	Interface	VREF	Output Settling Time (µs)	DNL (LSB)	Typical Standby Current (µA)	Typical Operating Current (µA)	Temp. Range (°C)	Packages
TC1320	8	1	SMBus	Ext	10	±0.8	0.1	350	-40 to +85	8-Pin MSOP, 8-Pin SOIC
TC1321	10	1	SMBus	Ext	10	±2	0.1	350	-40 to +85	8-Pin MSOP, 8-Pin SOIC
MCP4821	12	1	SPI	Y	4.5	1	0.3	330	-40 to +125	8-Pin PDIP, 8-Pin SOIC, 8-Pin MSOP
MCP4822	12	2	SPI	Y	4.5	1	0.3	415	-40 to +125	8-Pin PDIP, 8-Pin SOIC, 8-Pin MSOP
MCP4921	12	1	SPI	Ext	4.5	0.75	1	175	-40 to +125	8-Pin PDIP, 8-Pin SOIC, 8-Pin MSOP
MCP4922	12	2	SPI	Ext	4.5	0.75	1	350	-40 to +125	14-Pin PDIP, 14-Pin SOIC, 14-Pin TSSOP

NOTE: The analog output is voltage.

### INTERFACE – Controller Area Network (CAN) Products

Part #	Operating Voltage (V)	Temperature Range (°C)	Tx Buffers	Rx Buffers	Filters	Masks	Interrupt Output	Unique Features	Packages
MCP2510 <sup>(1)</sup>	2.7 to 5.5	-40 to +125	3	2	6	2	Yes	CAN 2.0B Active controller with SPI interface to MCU, 3 transmit buffers, 2 receive buffers, HW and SW message triggers	18-Pin PDIP, 18-Pin SOIC, 20-Pin TSSOP
MCP2515	2.7 to 5.5	-40 to +125	3	2	6	2	Yes	MCP2510 pin compatible upgrade with enhanced features including higher throughput and data byte filtering	18-Pin PDIP, 18-Pin SOIC, 20-Pin TSSOP
MCP25020	2.7 to 5.5	-40 to +125	3	2	2	1	N/A	CAN 2.0B Active I/O Expander, Configurable I/O, 2 PWM outputs	14-Pin PDIP, 14-Pin SOIC
MCP25025	2.7 to 5.5	-40 to +85	3	2	2	1	N/A	CAN 2.0B Active I/O Expander, Configurable I/O, 2 PWM outputs, One-wire CAN option	14-Pin PDIP, 14-Pin SOIC
MCP25050	2.7 to 5.5	-40 to +125	3	2	2	1	N/A	Mixed-Signal CAN 2.0B Active I/O Expander, Configurable I/O, 4 10-bit ADCs, 2 PWM outputs	14-Pin PDIP, 14-Pin SOIC
MCP25055	2.7 to 5.5	-40 to +85	3	2	2	1	N/A	Mixed-Signal CAN 2.0B Active I/O Expander, Configurable I/O, 4 10-bit ADCs, 2 PWM outputs, One-wire CAN option	14-Pin PDIP, 14-Pin SOIC
MCP2551	4.5 to 5.5	-40 to +125	n/a	n/a	n/a	n/a	N/A	High-speed CAN Transceiver (1 Mbps max. CAN bus speed), ISO11898 compatible, Industry standard pinout	8-Pin PDIP, 8-Pin SOIC

NOTE 1: Not recommended for new designs.

### INTERFACE – Infrared Products

Part #	Operating Voltage (V)	Operating Temperature Range (°C)	Max. Baud Rate (Kbaud)	Unique Features	Packages
MCP2120	2.5 to 5.5	-40 to +85	325	UART to IR encoder/decoder with both hardware and software baud rate selection	14-Pin PDIP, 14-Pin SOIC
MCP2122	1.8 to 5.5	-40 to +85	16x less than clock input	UART to IR encoder/decoder	8-Pin PDIP, 8-Pin SOIC
MCP2140	2.7 to 5.5	-40 to +85	9.6	IrDA® Standard protocol handler plus bit encoder/decoder, Fixed baud rate, Low-cost applications, Programmable ID	18-Pin PDIP, 18-Pin SOIC, 20-Pin SSOP
MCP2150	3.0 to 5.5	-40 to +85	115.2	IrDA® Standard protocol handler plus bit encoder/decoder on one chip for DTE applications, Programmable ID	18-Pin PDIP, 18-Pin SOIC, 20-Pin SSOP
MCP2155	3.0 to 5.5	-40 to +85	115.2	IrDA® Standard protocol handler plus bit encoder/decoder on one chip for DCE applications, Programmable ID	18-Pin PDIP, 18-Pin SOIC, 20-Pin SSOP

NOTE: IrDA® is a registered trademark of Infrared Data Association.

### INTERFACE – Ethernet Products

Part #	Operating Voltage (V)	Operating Temperature Range (°C)	MAC	PHY	TX/RX Dual Port RAM	Bus Type	Max Bus Speed (MHz)	Features	Packages
ENC28J60	3.14 to 3.45	0 to +70	yes	10-Base-T	8 KB	SPI	25	Ethernet controller, IEEE 802.3 compatible, Loopback Test modes, Auto-polarity detection	28-Pin SOIC, 28-Pin SSOP, 28-Pin 6x6 QFN

**INTERFACE – LIN Transceiver Products**

Part #	Description	Vreg Output Voltage (V)	Operating Temperature Range (°C)	Vreg Output Current (mA)	Vcc Range (V)	Max Baud Rate	LIN Specification Supported	Packages
MCP201	LIN Transceiver with integrated VREG	4.75 to 5.25	-40 to +125	50	7.4 to 18 <sup>(1)</sup>	20 Kbaud	Revision 1.2	8-pin PDIP, 8-pin SOIC, 8-Pin DFN

NOTE 1: Can withstand 40V load dump.

**INTERFACE – Serial Peripherals**

Part #	Description	Operating Voltage (V)	Operating Temperature Range (°C)	Bus Type	Max. Bus Frequency (kHz)	Features	Packages
MCP23008	8-bit I/O Port Expander	1.8 to 5.5	-40 to +85	I <sup>2</sup> C™	1700	3 HW address pins, HW interrupt, 25 mA source/sink capability per I/O	18-Pin PDIP, 18-Pin SOIC, 20-Pin SSOP
MCP23S08	8-bit I/O Port Expander	1.8 to 5.5	-40 to +85	SPI	10000	2 HW address pins, HW interrupt, 25 mA source/sink capability per I/O	18-Pin PDIP, 18-Pin SOIC, 20-Pin SSOP
MCP23016	16-bit I/O Port Expander	2.0 to 5.5	-40 to +85	I <sup>2</sup> C™	400	3 HW address inputs, HW interrupt, 25 mA source/sink capability per I/O	28-Pin PDIP, 28-Pin SOIC, 28-Pin SSOP, 28-Pin 6x6 QFN
MCP23017	16-bit I/O expander	1.8 to 5.5	-40 to +125	I <sup>2</sup> C™	1,700	3 HW address pins, 25 mA sink/source per I/O, 100 kHz, 400 kHz and 3-4 MHz I <sup>2</sup> C™ supported, Interrupt output	28-Pin PDIP, 28-Pin SOIC, 28-Pin SSOP, 28-Pin QFN
MCP23S17	16-bit I/O expander	1.8 to 5.5	-40 to +125	SPI	10,000	3 HW address pins, 25 mZ sink/source per I/O, Interrupt output	28-Pin PDIP, 28-Pin SOIC, 28-Pin SSOP, 28-Pin QFN

**INTERFACE – Passive Access Products**

Part #	Operating Voltage (V)	Operating Temp. Range (°C)	Bus Type	RF Carrier Frequency	Data Format	Features	Packages
MCP2030	1.8 to 3.6	-40 to +85	SPI	125 kHz	NRZ	Three axis signal conditioning devices for passive access applications, high-sensitivity, configurable smart wake-up filter	14-Pin PDIP, 14-Pin SOIC, 14-Pin TSSOP

## FUTURE ANALOG/INTERFACE PRODUCTS

Lead-free versions of many devices are currently offered. Check Microchip's web site for availability.

### Power Management – Low-Side Power MOSFET Drivers

Part #	Configuration	Operating Temperature Range (°C)	Peak Output Current (A)	Output Resistance (Ω)	Max. Supply Voltage	Input/Output Delay (td1, td2)	Packages
TC4420A	Single Inverting	-40 to +125	6	1.8 (typ)/2.0 (typ)	18	30/30	5-Pin TO-220, 8-Pin PDIP, 8-Pin 6x5 DFN, 8-Pin SOIC
TC4429A	Single, Non-inverting	-40 to +125	6	1.8 (typ)/2.0 (typ)	18	30/30	5-Pin TO-220, 8-Pin PDIP, 8-Pin 6x5 DFN, 8-Pin SOIC

### Power Management – Battery Chargers

Part #	Mode	Cell Type	# of Cells	Vcc Range (V)	Max. Voltage Regulation (%)	In/Ext FET	Features	Packages
MCP73837/8	Linear	Li-Ion/Li-Polymer	1	3.75 to 6.0	±0.5	Int	1A max Charging current, 2 Status outputs, Cell temperature monitor, LDO Test mode, USB/AC input auto-switch	10-Pin 3x3 DFN

### Power Management – Linear Regulators

Part #	Max. Input Voltage (V)	Output Voltage (V)	Output Current (mA)	Junction Temp. Range (°C)	Typical Active Current (µA)	Typical Dropout Voltage of Rated IOUT (mV)	Typical Output Voltage Accuracy (%)	Features	Packages
MCP1725	6.0	Fixed: 5, 3.3, 3.0, 2.5, 1.8, 1.2, 0.8 Adj: 0.8 to 5.0	500	-40 to +125	140	210	±0.5	Ceramic cap stable, shutdown, Cdelay, Power Good	8-Pin SOIC, 8-Pin 2x3 DFN

### Power Management – Switching Regulators

Part #	Description	Input Voltage (V)	Output Voltage (V)	Operating Temp. Range (°C)	Control Scheme	Switching Freq. (kHz)	Typical Active Current (mA)	Output Current (mA)	Features	Packages
MCP1602	Synchronous Buck DC/DC Regulator	2.7 to 5.5	0.8 to 4.5	-40 to +85	PWM/ PWM	2000	35	500	PFM, PWM auto-switching, UVLO, soft-start, Power Good	8-Pin MSOP, 8-Pin 3x3 DFN
MCP1603	Synchronous Buck DC/DC Regulator	2.7 to 5.5	0.8 to 4.5	-40 to +85	PWM/ PWM	2000	35	500	PFM, PWM auto-switching, UVLO, soft-start	5-Pin SOT-23, 8-Pin 2x3 DFN

### Linear – Linear Gain Blocks

Part #	Channels	-3dB BW (kHz)	Iq (µA)	Vos (mV)	Operating Voltage (V)	Temperature Range (°C)	Gain Steps (V/V)	Features	Packages
MCP6G01	1	1000	120	3	1.8 to 5.5	-40 to +125	1, 10, 50	Tri-State Control Pin	8-Pin PDIP, 8-Pin SOIC, 8-Pin TSSOP
MCP6G02	2	1000	120	3	1.8 to 5.5	-40 to +125	1, 10, 50	Tri-State Control Pin	8-Pin PDIP, 8-Pin SOIC, 8-Pin TSSOP
MCP6G04	4	1000	120	3	1.8 to 5.5	-40 to +125	1, 10, 50	Tri-State Control Pin	14-Pin PDIP, 14-Pin SOIC, 14-Pin TSSOP

# CURRENT 8-BIT PICmicro® MICROCONTROLLER FAMILY PRODUCTS

Product	Program Memory (Kbytes/ K words)	Self-Write	RAM (Kbytes)	I/O Pins	Packages	Analog		Digital Timers/WDT	Max. Speed MHz	IntOSC	ICSP™	BOR/ PBOR/ PLVD	ICD # of Breakpoints	Operating Voltage (V)	Other Features
						ADC	Comp.								
<b>Baseline 8-Bit PICmicro® Microcontroller Family (12-Bit Instruction Word)</b>															
<b>PIC10FXXX: 500 ns Instruction Execution, 33 Instructions, 25 mA Source and Sink per I/O</b>															
PIC10F200	0.375/0.25	—	16	4	60T, 8P	—	—	1-8 bit, 1-WDT	4	4 MHz	✓	—	1**	2.0-5.5	
PIC10F202	0.75/0.50	—	24	4	60T, 8P	—	—	1-8 bit, 1-WDT	4	4 MHz	✓	—	1**	2.0-5.5	
PIC10F204	0.375/0.25	—	16	4	60T, 8P	—	1	1-8 bit, 1-WDT	4	4 MHz	✓	—	1**	2.0-5.5	Band gap reference
PIC10F206	0.75/0.50	—	24	4	60T, 8P	—	1	1-8 bit, 1-WDT	4	4 MHz	✓	—	1**	2.0-5.5	Band gap reference
PIC10F220	0.375/0.25	—	16	4	60T, 8P	2x8-bit	—	1-8 bit, 1-WDT	8	8 MHz	✓	—	1**	2.0-5.5	Band gap reference
PIC10F222	0.75/0.50	—	23	4	60T, 8P	2x8-bit	—	1-8 bit, 1-WDT	8	8 MHz	✓	—	1**	2.0-5.5	Band gap reference
<b>PIC12FXXX: 500 ns Instruction Execution, 33 Instructions, 25 mA Source and Sink per I/O</b>															
PIC12F508	0.75/0.50	—	25	6	8P, 8SN, 8MS	—	—	1-8 bit, 1-WDT	4	4 MHz	✓	—	1**	2.0-5.5	
PIC12F509	1.5/1	—	41	6	8P, 8SN, 8MS	—	—	1-8 bit, 1-WDT	4	4 MHz	✓	—	1**	2.0-5.5	
PIC12F510	1.5/1	—	38	6	8P, 8SN, 8MS	3x8-bit	1	1-8 bit, 1-WDT	8	8 MHz	✓	—	1**	2.0-5.5	Band gap reference
<b>PIC16F5XX: 100-200 ns Instruction Execution, 33 Instructions, 25 mA Source and Sink per I/O</b>															
PIC16F505	1.5/1	—	72	12	14P, 14SL, 14ST	—	—	1-8 bit, 1-WDT	20	4 MHz	✓	—	1**	2.0-5.5	
PIC16F506	1.5/1	—	67	12	14P, 14SL, 14ST	3x8-bit	2	1-8 bit, 1-WDT	20	8 MHz	✓	—	1**	2.0-5.5	Band gap reference
PIC16F54	0.75/0.50	—	25	12	18P, 18SO, 20SS	—	—	1-8 bit, 1-WDT	20	—	✓	—	—	2.0-5.5	
PIC16F57	3/2	—	72	20	28P, 28SO, 28SS, 28SP	—	—	1-8 bit, 1-WDT	20	—	✓	—	—	2.0-5.5	
PIC16F59	3/2	—	134	32	40P, 44PT	—	—	1-8 bit, 1-WDT	20	—	✓	—	—	2.0-5.5	
<b>PIC16C5X: 100-200 ns Instruction Execution, 33 Instructions, 25 mA Source and Sink per I/O</b>															
PIC16C55A	0.75/0.50	—	24	20	28P, 28JW, 28SP, 28SO, 28SS	—	—	1-8 bit, 1-WDT	40	—	—	—	—	2.5-5.5	
PIC16C56A	1.5/1	—	25	12	18P, 18JW, 18SO, 20SS	—	—	1-8 bit, 1-WDT	40	—	—	—	—	2.5-5.5	
PIC16C56A	1.5/1	—	25	12	18P, 18SO, 20SS	—	—	1-8 bit, 1-WDT	20	—	—	—	—	2.5-5.5	
PIC16C58B	3/2	—	73	12	18P, 18JW, 18SO, 20SS	—	—	1-8 bit, 1-WDT	40	—	—	—	—	2.5-5.5	
PIC16C58B	3/2	—	73	12	18P, 18SO, 20SS	—	—	1-8 bit, 1-WDT	20	—	—	—	—	2.5-5.5	
PIC16HV540	1.5/0.50	—	25	12	18P, 18JW, 18SO, 20SS	—	—	1-8 bit, 1-WDT	20	—	—	BOR	—	3.5-15	8 high-voltage (15V) I/Os, 4 deep stack, 5 I/Os with wake-up-on-change

\*Contact Microchip Technology for availability date.

\*\* Requires ICD specific device with header module – refer to Development Tools. Abbreviations are found on the last page of the Selector Guide.

**Mid-Range 8-Bit PICmicro® Microcontroller Family (14-Bit Instruction Word)**

Product	Program Memory (Kbytes/ K words)	Self-Write	Data EEPROM (Bytes)	RAM (Kbytes)	I/O Pins	Packages	Analog		Digital		Max. Speed MHz	IntOSC	BOR/ PBOR/ PLVD	ICD # of Breakpoints	CCP/ ECCP	nW	Other Features
							ADC Ch	Comp.	Timers/WDT	Serial I/O							
<b>PIC12CXXX: 200 ns Instruction Execution, 35 Instructions, ICSP™</b>																	
PIC12F629	1.75/1	—	128	64	6	8P, 8SN, 8MD	—	1	1-8 bit, 1-16 bit, 1-WDT	—	20	4 MHz	BOR	1**	—	—	—
PIC12F635	1.75/1	—	128	64	6	8P, 8SN, 8MD	—	1	1-8 bit, 1-16 bit, 1-WDT	—	20	8 MHz, 32 KHz	BOR/ PLVD	1**	—	✓	KEELOQ® hardware peripheral, WUR
PIC12F675	1.75/1	—	128	64	6	8P, 8SN, 8MD	4x10-bit	1	1-8 bit, 1-16 bit, 1-WDT	—	20	4 MHz	BOR	1**	—	—	—
PIC12F683	3.5/2	—	256	128	6	8P, 8SN, 8MD	4x10-bit	1	1-16 bit, 2-8 bit, 1-WDT	—	20	8 MHz, 32 KHz	BOR	1**	1/0	✓	—
<b>PIC16FXXX: 200 ns Instruction Execution, 35 Instructions, ICSP™ (except ROM), 25 mA Source and Sink per I/O</b>																	
PIC16F616*	3.5/2	—	—	128	12	14P, 14SL, 14ST, 16ML	8x10-bit	2	1-16 bit, 2-8 bit, 1-WDT	—	20	8 MHz	BOR	1**	0/1	—	High-Voltage Option with Internal Shunt Regulator, SR-Latch
PIC16F627A	1.75/1	—	128	224	16	18P, 18SO, 20SS, 28ML	—	2	1-16 bit, 2-8 bit, 1-WDT	AUSART	20	4 MHz	BOR	1**	1/0	✓	—
PIC16F628A	3.5/2	—	128	224	16	18P, 18SO, 20SS, 28ML	—	2	1-16 bit, 2-8 bit, 1-WDT	AUSART	20	4 MHz	BOR	1**	1/0	✓	—
PIC16F631*	1.75/1	—	128	64	18	20P, 20SO, 20SS, 20ML	—	2	1-16 bit, 1-8 bit, 1-WDT	—	20	8 MHz, 32 KHz	BOR	1**	—	✓	SR-Latch
PIC16F648A	7/4	—	256	256	16	18P, 18SO, 20SS, 28ML	—	2	1-16 bit, 2-8 bit, 1-WDT	AUSART	20	4 MHz	BOR	1**	1/0	✓	—
PIC16F630	1.75/1	—	128	64	12	14P, 14SL, 14ST, 16ML	—	1	1-8 bit, 1-16 bit, 1-WDT	—	20	4 MHz	BOR	1**	—	—	—
PIC16F636	3.5/2	—	256	128	12	14P, 14SL, 14ST, 16ML	—	2	1-8 bit, 1-16 bit, 1-WDT	—	20	8 MHz, 32 KHz	BOR/ PLVD	1**	—	✓	KEELOQ® hardware peripheral, WUR
PIC16F639	3.5/2	—	256	128	12	20SS	—	2	1-16 bit, 1-8 bit, 1-WDT	—	20	8 MHz, 32 KHz	BOR	1**	—	✓	Transponder Analog Front End, KEELOQ® hardware peripheral, WUR
PIC16F676	1.75/1	—	128	64	12	14P, 14SL, 14ST, 16ML	8x10-bit	1	1-8 bit, 1-16 bit, 1-WDT	—	20	4 MHz	BOR	1**	—	—	—
PIC16F677*	3.5/2	—	256	128	18	20P, 20SO, 20SS, 20ML	12x10-bit	2	1-16 bit, 1-8 bit, 1-WDT	I <sup>2</sup> C/SPI	20	8 MHz, 32 KHz	BOR	1**	—	✓	SR-Latch
PIC16F684	3.5/2	—	256	128	12	14P, 14SL, 14ST, 16ML	8x10-bit	2	1-16 bit, 2-8 bit, 1-WDT	—	20	8 MHz, 32 KHz	BOR	1**	0/1	✓	—
PIC16F685	7/4	—	256	256	18	20P, 20SO, 20SS, 20ML	12x10-bit	2	1-16 bit, 2-8 bit, 1-WDT	—	20	8 MHz, 32 KHz	BOR	1**	0/1	✓	SR-Latch
PIC16F687	3.5/2	—	256	128	18	20P, 20SO, 20SS, 20ML	12x10-bit	2	1-16 bit, 1-8 bit, 1-WDT	EUSART, I <sup>2</sup> C/SPI	20	8 MHz, 32 KHz	BOR	1**	—	✓	SR-Latch
PIC16F688	7/4	—	256	256	12	14P, 14SL, 14ST, 16ML	8x10-bit	2	1-8 bit, 1-16 bit, 1-WDT	EUSART	20	8 MHz, 32 KHz	BOR	1**	—	✓	—
PIC16F689	7/4	—	256	256	18	20P, 20SO, 20SS, 20ML	12x10-bit	2	1-16 bit, 1-8 bit, 1-WDT	EUSART, I <sup>2</sup> C/SPI	20	8 MHz, 32 KHz	BOR	1**	—	✓	SR-Latch
PIC16F690	7/4	—	256	256	18	20P, 20SO, 20SS, 20ML	12x10-bit	2	1-16 bit, 2-8 bit, 1-WDT	EUSART, I <sup>2</sup> C/SPI	20	8 MHz, 32 KHz	BOR	1**	0/1	✓	SR-Latch
PIC16F716	3.5/2	—	—	128	13	18P, 18SO, 20SS	4x8-bit	—	1-16 bit, 2-8 bit, 1-WDT	—	20	—	BOR	1**	0/1	—	—

\*Contact Microchip Technology for availability date.

\*\* Requires ICD specific device with header module – refer to Development Tools. Abbreviations are found on the last page of the Selector Guide.

**NEW**

**NEW**

**NEW**

**NEW**

Mid-Range 8-Bit PICmicro® Microcontroller Family (14-Bit Instruction Word) (continued)

Product	Program Memory (Kbytes/ K words)	Self-Write	Data EEPROM (Bytes)	RAM (Kbytes)	I/O Pins	Packages	Analog		Digital		Max. Speed MHz	IntOSC	BOR/ PBOR/ PLVD	ICD # of Breakpoints	CCP/ ECCP	nW	Other Features
							ADC Ch	Comp.	Timers/WDT	Serial I/O							
<b>PIC16FXXX: 200 ns Instruction Execution, 35 Instructions, ICSP™ (except ROM), 25 mA Source and Sink per I/O (continued)</b>																	
PIC16F72	3.5/2	—	—	128	22	28SP, 28SO, 28SS, 28ML	5x8-bit	—	1-16 bit, 2-8 bit, 1-WDT	I <sup>2</sup> C/SPI	20	—	BOR	—	1/0	—	
PIC16F73	7/4	—	—	192	22	28SP, 28SO, 28SS, 28ML	5x8-bit	—	1-16 bit, 2-8 bit, 1-WDT	USART, I <sup>2</sup> C/SPI	20	—	BOR	—	2/0	—	
PIC16F737	7/4	—	—	368	25	28SP, 28SO, 28SS, 28ML	11x10-bit	2	1-16 bit, 2-8 bit, 1-WDT	AUSART, MI <sup>2</sup> C/SPI	20	8 MHz	PBOR/ PLVD	1	3/0	✓	
PIC16F74	7/4	—	—	192	33	40P, 44ML, 44L, 44PT	8x8-bit	—	1-16 bit, 2-8 bit, 1-WDT	USART, I <sup>2</sup> C/SPI	20	—	BOR	—	2/0	—	PSP
PIC16F747	7/4	—	—	368	36	40P, 44PT, 44ML	14x10-bit	2	1-16 bit, 2-8 bit, 1-WDT	AUSART, MI <sup>2</sup> C/SPI	20	8 MHz	PBOR/ PLVD	1	3/0	✓	PSP
PIC16F76	14/8	—	—	368	22	28SP, 28SO, 28SS, 28ML	5x8-bit	—	1-16 bit, 2-8 bit, 1-WDT	USART, I <sup>2</sup> C/SPI	20	—	BOR	—	2/0	—	
PIC16F767	14/8	—	—	368	25	28SP, 28SO, 28SS, 28ML	11x10-bit	2	1-16 bit, 2-8 bit, 1-WDT	AUSART, MI <sup>2</sup> C/SPI	20	8 MHz	PBOR/ PLVD	1	3/0	✓	
PIC16F77	14/8	—	—	368	33	40P, 44ML, 44L, 44PT	8x8-bit	—	1-16 bit, 2-8 bit, 1-WDT	USART, I <sup>2</sup> C/SPI	20	—	BOR	—	2/0	—	PSP
PIC16F777	14/8	—	—	368	36	40P, 44PT, 44ML	14x10-bit	2	1-16 bit, 2-8 bit, 1-WDT	AUSART, MI <sup>2</sup> C/SPI	20	8 MHz	PBOR/ PLVD	1	3/0	✓	PSP
PIC16F785	3.5/2	—	256	128	18	20P, 20SO, 20SS, 20ML	12x10-bit	2	1-16 bit, 2-8 bit, 1-WDT	—	20	8 MHz 32 KHz	BOR	1**	1/0	✓	2-phase PWM, 2 x Op Amp, VREF, High-Voltage Option with Internal Shunt Regulator
PIC16F818	1.75/1	✓	128	128	16	18P, 18SO, 20SS, 28ML	5x10-bit	—	1-16 bit, 2-8 bit, 1-WDT	I <sup>2</sup> C/SPI	20	8 MHz	BOR	1	1/0	✓	
PIC16F819	3.5/2	✓	256	256	16	18P, 18SO, 20SS, 28ML	5x10-bit	—	1-16 bit, 2-8 bit, 1-WDT	I <sup>2</sup> C/SPI	20	8 MHz	BOR	1	1/0	✓	
PIC16F84A	1.75/1	—	64	68	13	18P, 18SO, 20SS	—	—	1-8 bit, 1-WDT	—	20	—	—	—	—	—	
PIC16F87	7/4	✓	256	368	16	18P, 18SO, 20SS, 28ML	—	2	1-16 bit, 2-8 bit, 1-WDT	AUSART, I <sup>2</sup> C/SPI	20	8 MHz	BOR	1	1/0	✓	
PIC16F870	3.5/2	✓	64	128	22	28SP, 28SO, 28SS	5x10-bit	—	1-16 bit, 2-8 bit, 1-WDT	AUSART	20	—	BOR	1	1/0	—	
PIC16F871	3.5/2	✓	64	128	33	40P, 44L, 44PT	8x10-bit	—	1-16 bit, 2-8 bit, 1-WDT	AUSART	20	—	BOR	1	1/0	—	PSP
PIC16F872	3.5/2	✓	64	128	22	28SP, 28SO, 28SS	5x10-bit	—	1-16 bit, 2-8 bit, 1-WDT	MI <sup>2</sup> C/SPI	20	—	BOR	1	1/0	—	
PIC16F873A	7/4	✓	128	192	22	28SP, 28SO, 28SS, 28ML	5x10-bit	2	1-16 bit, 2-8 bit, 1-WDT	AUSART, MI <sup>2</sup> C/SPI	20	—	BOR	1	2/0	—	
PIC16F874A	7/4	✓	128	192	33	40P, 44ML, 44L, 44PT	8x10-bit	2	1-16 bit, 2-8 bit, 1-WDT	AUSART, MI <sup>2</sup> C/SPI	20	—	BOR	1	2/0	—	PSP
PIC16F876A	14/8	✓	256	368	22	28SP, 28SO, 28SS, 28ML	5x10-bit	2	1-16 bit, 2-8 bit, 1-WDT	AUSART, MI <sup>2</sup> C/SPI	20	—	BOR	1	2/0	—	
PIC16F877A	14/8	✓	256	368	33	40P, 44ML, 44L, 44PT	8x10-bit	2	1-16 bit, 2-8 bit, 1-WDT	AUSART, MI <sup>2</sup> C/SPI	20	—	BOR	1	2/0	—	PSP

\*Contact Microchip Technology for availability date.

\*\* Requires ICD specific device with header module – refer to Development Tools. Abbreviations are found on the last page of the Selector Guide.



**Mid-Range 8-Bit PICmicro® Microcontroller Family (14-Bit Instruction Word) (continued)**

Product	Program Memory (Kbytes/ K words)	Self-Write	Data EEPROM (Bytes)	RAM (Kbytes)	I/O Pins	Packages	Analog		Digital		Max. Speed MHz	IntOSC	BOR/ PBOR/ PLVD	ICD # of Breakpoints	CCP/ ECCP	nW	Other Features
							ADC Ch	Comp.	Timers/WDT	Serial I/O							
<b>PIC16FXXX: 200 ns Instruction Execution, 35 Instructions, ICSP™ (except ROM), 25 mA Source and Sink per I/O (continued)</b>																	
PIC16F88	7/4	✓	256	368	16	18P, 18SO, 20SS, 28ML	7x10-bit	2	1-16 bit, 2-8 bit, 1-WDT	AUSART, I <sup>2</sup> C/SPI	20	8 MHz	BOR	1	1/0	✓	
PIC16F883*	7/4	✓	256	256	25	28P, 28SO, 28SS, 28ML	11x10-bit	2	1-16 bit, 2-8 bit, 1-WDT	EUSART, MI <sup>2</sup> C/SPI	20	8 MHz, 32 kHz	BOR	1	1/1	✓	SR-Latch
PIC16F884*	7/4	✓	256	256	36	40P, 44PT, 44ML	14x10-bit	2	1-16 bit, 2-8 bit, 1-WDT	EUSART, MI <sup>2</sup> C/SPI	20	8 MHz, 32 kHz	BOR	1	1/1	✓	SR-Latch
PIC16F886*	14/8	✓	256	368	25	28P, 28SO, 28SS, 28ML	11x10-bit	2	1-16 bit, 2-8 bit, 1-WDT	EUSART, MI <sup>2</sup> C/SPI	20	8 MHz, 32 kHz	BOR	1	1/1	✓	SR-Latch
PIC16F887*	14/8	✓	256	368	36	40P, 44PT, 44ML	14x10-bit	2	1-16 bit, 2-8 bit, 1-WDT	EUSART, MI <sup>2</sup> C/SPI	20	8 MHz, 32 kHz	BOR	1	1/1	✓	SR-Latch
PIC16F913	7/4	—	256	256	25	28P, 28SO, 28SS, 28ML	5x10-bit	2	1-16 bit, 2-8 bit, 1-WDT	AUSART, I <sup>2</sup> C/SPI	20	8 MHz, 32 kHz	BOR/ PLVD	1	1/0	✓	Integrated LCD control modules with 60 Segments
PIC16F914	7/4	—	256	256	36	40P, 44PT, 44ML	8x10-bit	2	1-16 bit, 2-8 bit, 1-WDT	AUSART, I <sup>2</sup> C/SPI	20	8 MHz, 32 kHz	BOR/ PLVD	1	2/0	✓	Integrated LCD control modules with 96 Segments
PIC16F916	14/8	—	256	352	25	28P, 28SO, 28SS, 28ML	5x10-bit	2	1-16 bit, 2-8 bit, 1-WDT	AUSART, I <sup>2</sup> C/SPI	20	8 MHz, 32 kHz	BOR/ PLVD	1	1/0	✓	Integrated LCD control modules with 60 Segments
PIC16F917	14/8	—	256	352	36	40P, 44PT, 44ML	8x10-bit	2	1-16 bit, 2-8 bit, 1-WDT	AUSART, I <sup>2</sup> C/SPI	20	8 MHz, 32 kHz	BOR/ PLVD	1	2/0	✓	Integrated LCD control modules with 96 Segments
PIC16F946	14/8	—	256	336	53	64PT	8x10-bit	2	1-16 bit, 2-8 bit, 1-WDT	AUSART/ I <sup>2</sup> C/SPI	20	8 MHz, 32 kHz	BOR/ PLVD	1	2/0	✓	Integrated LCD control modules with 168 Segments
<b>PIC16CXXX: 100-200 ns Instruction Execution, 35 Instructions, ICSP™ (except ROM), 25 mA Source and Sink per I/O</b>																	
PIC14000	7/4	—	—	192	20	28SP, 28SO, 28SS, 28JW	8 SLAC	2	1-8 bit, 1-16 bit, 1-WDT	I <sup>2</sup> C/SMB	20	4 MHz	—	—	—	—	Temperature Sensor, Program Reference Generator
PIC16C432	3.5/2	—	—	128	12	20SS, 20P, 20JW	—	2	1-8 bit, 1-WDT	LIN	20	—	BOR	—	—	—	LIN XCVR, 18V/40 mA
PIC16C433	3.5/2	—	—	128	6	18SO, 18P, 18JW	4x8-bit	—	1-8 bit, 1-WDT	LIN	10	4 MHz	—	—	—	—	LIN XCVR, 18V/40 mA
PIC16C554	0.875/0.50	—	—	80	13	18P, 18SO, 18JW, 20SS	—	—	1-8 bit, 1-WDT	—	20	—	—	—	—	—	
PIC16C558	3.5/2	—	—	128	13	18P, 18SO, 18JW, 20SS	—	—	1-8 bit, 1-WDT	—	20	—	—	—	—	—	
PIC16C62B	3.5/2	—	—	128	22	28SP, 28SO, 28SS, 28JW, 28ML	—	—	1-16 bit, 2-8 bit, 1-WDT	I <sup>2</sup> C/SPI	20	—	BOR	—	1/0	—	
PIC16C620A	0.875/0.50	—	—	96	13	18P, 18SO, 18JW, 20SS	—	2	1-8 bit, 1-WDT	—	40	—	BOR	—	—	—	
PIC16C620A	0.875/0.50	—	—	96	13	18P, 18SO, 20SS	—	2	1-8 bit, 1-WDT	—	20	—	BOR	—	—	—	
PIC16C621A	1.75/1	—	—	96	13	18P, 18SO, 18JW, 20SS	—	2	1-8 bit, 1-WDT	—	40	—	BOR	—	—	—	
PIC16C622A	3.5/2	—	—	128	13	18P, 18SO, 18JW, 20SS	—	2	1-8 bit, 1-WDT	—	40	—	BOR	—	—	—	
PIC16C63A	7/4	—	—	192	22	28SP, 28SO, 28SS, 28JW, 28ML	—	—	1-16 bit, 2-8 bit, 1-WDT	USART, I <sup>2</sup> C/SPI	20	—	BOR	—	2/0	—	
PIC16C63	7/4	—	—	192	22	28SP, 28SO, 28SS	—	—	1-16 bit, 2-8 bit, 1-WDT	USART, I <sup>2</sup> C/SPI	20	—	BOR	—	2/0	—	

\*Contact Microchip Technology for availability date.

\*\* Requires ICD specific device with header module – refer to Development Tools. Abbreviations are found on the last page of the Selector Guide.

**Mid-Range 8-Bit PICmicro® Microcontroller Family (14-Bit Instruction Word) (continued)**

Product	Program Memory (Kbytes/ K words)	Self-Write	Data EEPROM (Bytes)	RAM (Kbytes)	I/O Pins	Packages	Analog		Digital		Max. Speed MHz	IntOSC	BOR/ PBOR/ PLVD	ICD # of Breakpoints	CCP/ ECCP	nW	Other Features
							ADC Ch	Comp.	Timers/WDT	Serial I/O							
<b>PIC16CXXX: 100-200 ns Instruction Execution, 35 Instructions, ICSP™ (except ROM), 25 mA Source and Sink per I/O (continued)</b>																	
PIC16C65B	7/4	—	—	192	33	40P, 40JW, 44L, 44PQ, 44PT	—	—	1-16 bit, 2-8 bit, 1-WDT	USART, I <sup>2</sup> C/SPI	20	—	BOR	—	2/0	—	PSP
PIC16CR65	7/4	—	—	192	33	40P, 44L, 44PQ, 44PT	—	—	1-16 bit, 2-8 bit, 1-WDT	USART, I <sup>2</sup> C/SPI	20	—	BOR	—	2/0	—	PSP
PIC16C717	3.5/2	—	—	256	16	18P, 18SO, 18JW, 20SS	6x10-bit	—	1-16 bit, 2-8 bit, 1-WDT	M <sup>2</sup> C/SPI	20	4 MHz	PBOR/ PLVD	—	0/1	—	
PIC16CR72	3.5/2	—	—	128	22	28SP, 28SO, 28SS	5x8-bit	—	1-16 bit, 2-8 bit, 1-WDT	I <sup>2</sup> C/SPI	20	—	BOR	—	1/0	—	
PIC16C745	14/8	—	—	256	22	28SP, 28SO, 28JW	5x8-bit	—	1-16 bit, 2-8 bit, 1-WDT	USART, low-speed USB	24	—	BOR	—	2/0	—	USB 1.1, 64 bytes dual port RAM
PIC16C765	14/8	—	—	256	33	40P, 40JW, 44L, 44PT	8x8-bit	—	1-16 bit, 2-8 bit, 1-WDT	USART, low-speed USB	24	—	BOR	—	2/0	—	USB 1.1, 64 bytes dual port RAM, PSP
PIC16C770	3.5/2	—	—	256	16	20P, 20SO, 20JW, 20SS	6x12-bit	—	1-16 bit, 2-8 bit, 1-WDT	M <sup>2</sup> C/SPI	20	4 MHz	PBOR/ PLVD	—	0/1	—	
PIC16C771	7/4	—	—	256	16	20P, 20SO, 20JW, 20SS	6x12-bit	—	1-16 bit, 2-8 bit, 1-WDT	M <sup>2</sup> C/SPI	20	4 MHz	PBOR/ PLVD	—	0/1	—	
PIC16C773	7/4	—	—	256	22	28SP, 28SO, 28SS, 28JW	6x12-bit	—	1-16 bit, 2-8 bit, 1-WDT	AUSART, M <sup>2</sup> C/SPI	20	—	PBOR/ PLVD	—	2/0	—	
PIC16C774	7/4	—	—	256	33	40P, 40JW, 44L, 44PQ, 44PT	10x12-bit	—	1-16 bit, 2-8 bit, 1-WDT	AUSART, M <sup>2</sup> C/SPI	20	—	PBOR/ PLVD	—	2/0	—	PSP
PIC16C781	1.75/1	—	—	128	16	20P, 20SO, 20SS, 20JW	8x8-bit	2	1-16 bit, 2-8 bit, 1-WDT	—	20	4 MHz	PBOR	—	—	—	Op Amp, PSMC, DAC
PIC16C782	3.5/2	—	—	128	16	20P, 20SO, 20SS, 20JW	8x8-bit	2	1-16 bit, 2-8 bit, 1-WDT	—	20	4 MHz	PBOR/ PLVD	—	—	—	Op Amp, PSMC, DAC
PIC16C925	7/4	—	—	176	52	64PT, 68CL, 68L	5x10-bit	—	1-16 bit, 2-8 bit, 1-WDT	I <sup>2</sup> C/SPI	20	—	BOR	—	1/0	—	LCD module, static, 1/2, 1/3, 1/4 multiplex
PIC16C926	14/8	—	—	336	52	64PT, 68CL, 68L	5x10-bit	—	1-16 bit, 2-8 bit, 1-WDT	I <sup>2</sup> C/SPI	20	—	BOR	—	1/0	—	LCD module, static, 1/2, 1/3, 1/4 multiplex

\*Contact Microchip Technology for availability date.  
 \*\* Requires ICD specific device with header module – refer to Development Tools.  
 Abbreviations are found on the last page of the Selector Guide.

**High-Performance 8-Bit PICmicro® Microcontroller Family (16-Bit Instruction Word)**

Product	Program Memory (Kbytes/ K words)	Self-Write	Data EEPROM (Bytes)	RAM (Bytes)	I/O Pins	Packages	Analog		Digital		Max. Speed MHz	IntOSC	BOR/ PBOR/ PLVD	ICD # of Breakpoints	CCP/ ECCP	nW	Other Features
							ADC Ch	Comp.	Timers/WDT	Serial I/O							
<b>PIC18 Flash MCUs: 10 MIPS, V<sub>DD</sub> = 2.0V-5.5V, Upwardly Compatible with PIC16C, 77 Instructions, C Compiler Efficient Instruction Set</b>																	
PIC18C601	ROM-less	—	—	1536	26	64PT, 68L	8x10-bit 30 kspcs	—	3-16 bit, 1-8 bit, 1-WDT	AUSART, M <sup>2</sup> C/SPI	25	—	—	—	2/0	—	256 KB EMA, Bootloader RAM
PIC18C801	ROM-less	—	—	1536	37	80PT, 84L	12x10-bit 30 kspcs	—	3-16 bit, 1-8 bit, 1-WDT	AUSART, M <sup>2</sup> C/SPI	25	—	—	—	2/0	—	2 MB EMA, Bootloader RAM

\*Contact Microchip Technology for availability date.  
 Abbreviations are found on the last page of the Selector Guide.

### High-Performance 8-Bit PICmicro® Microcontroller Family (16-Bit Instruction Word) (continued)

Product	Program Memory (Kbytes/ K words)	Self-Write	Data EEPROM (Bytes)	RAM (Bytes)	I/O Pins	Packages	Analog		Digital		Max. Speed MHz	IntOSC	BOR/ PBOR/ PLVD	ICD # of Breakpoints	CCP/ ECCP	nW	Other Features
							ADC Ch	Comp.	Timers/WDT	Serial I/O							
<b>PIC18 Flash MCUs: 10 MIPS, VDD = 2.0V-5.5V, Upwardly Compatible with PIC16C, 77 Instructions, C Compiler Efficient Instruction Set (continued)</b>																	
PIC18F1220	4/2	✓	256	256	16	18P, 18SO, 20SS, 28ML	7x10-bit 30 kcps	—	3-16 bit, 1-8 bit, 1-WDT	EUSART	40	8 MHz 32 kHz	PBOR/ PLVD	1	0/1	✓	
PIC18F1230*	4/2	✓	128	256	16	18P, 18SO, 20SS, 28ML	4x10-bit 100 kcps	3	2-16 bit, 1-WDT	EUSART	40	8 MHz 32 kHz	PBOR/ PLVD	3	—	✓	6-channel 14-bit Motor Control PWMs
PIC18F1320	8/4	✓	256	256	16	18P, 18SO, 20SS, 28ML	7x10-bit 30 kcps	—	3-16 bit, 1-8 bit, 1-WDT	EUSART	40	8 MHz 32 kHz	PBOR/ PLVD	1	0/1	✓	
PIC18F1330*	8/4	✓	128	256	16	18P, 18SO, 20SS, 28ML	4x10-bit 100 kcps	3	2-16 bit, 1-WDT	EUSART	40	8 MHz 32 kHz	PBOR/ PLVD	3	—	✓	6-channel 14-bit Motor Control PWMs
PIC18F2220	4/2	✓	256	512	25	28SP, 28SO	10x10-bit 30 kcps	2	3-16 bit, 1-8 bit, 1-WDT	AUSART, MI <sup>2</sup> C/SPI	40	8 MHz 32 kHz	PBOR/ PLVD	1	2/0	✓	
PIC18F2221*	4/2	✓	256	512	25	28SP, 28SO, 28ML	10x10-bit 100 kcps	2	3-16 bit, 1-8 bit, 1-WDT	EUSART, MI <sup>2</sup> C/SPI	40	8 MHz 32 kHz	PBOR/ PLVD	3	2/0	✓	
PIC18F2320	8/4	✓	256	512	25	28SP, 28SO	10x10-bit 30 kcps	2	3-16 bit, 1-8 bit, 1-WDT	AUSART, MI <sup>2</sup> C/SPI	40	8 MHz 32 kHz	PBOR/ PLVD	1	2/0	✓	
PIC18F2321*	8/4	✓	256	512	25	28SP, 28SO, 28ML	10x10-bit 100 kcps	2	3-16 bit, 1-8 bit, 1-WDT	EUSART, MI <sup>2</sup> C/SPI	40	8 MHz 32 kHz	PBOR/ PLVD	3	2/0	✓	
PIC18F2331	8/4	✓	256	768	24	28SP, 28SO, 28MM	5x10-bit, 200 kcps	—	3-16 bit, 1-8 bit, 1-WDT	EUSART, I <sup>2</sup> C/SPI	40	8 MHz 32 kHz	PBOR/ PLVD	1	2/0	✓	6-channel 14-bit Motor Control PWMs, 2-ch Quadrature Encoder
PIC18F2410	16/8	✓	—	768	25	28SP, 28SO, 28ML	10x10-bit 100 kcps	2	3-16 bit, 1-8 bit, 1-WDT	EUSART, MI <sup>2</sup> C/SPI	40	8 MHz 32 kHz	PBOR/ PLVD	3	2/0	✓	
PIC18F2420	16/8	✓	256	768	25	28SP, 28SO, 28ML	10x10-bit 100 kcps	2	3-16 bit, 1-8 bit, 1-WDT	EUSART, MI <sup>2</sup> C/SPI	40	8 MHz 32 kHz	PBOR/ PLVD	3	2/0	✓	
PIC18F2423*	16/8	✓	256	768	25	28SP, 28SO, 28ML	10x12-bit 100 kcps	2	3-16 bit, 1-8 bit, 1-WDT	EUSART, MI <sup>2</sup> C/SPI	32	8 MHz 32 kHz	PBOR/ PLVD	3	2/0	✓	VDD = 2.7V-3.6V
PIC18F2431	16/8	✓	256	768	24	28SP, 28SO, 28MM	5x10-bit, 200 kcps	—	3-16 bit, 1-8 bit, 1-WDT	EUSART, I <sup>2</sup> C/SPI	40	8 MHz 32 kHz	PBOR/ PLVD	1	2/0	✓	6-channel 14-bit Motor Control PWMs, 2-ch Quadrature Encoder
PIC18F2450	16/8	✓	—	768	23	28SP, 28SO, 28ML	10x10-bit, 100 kcps	—	2-16 bit, 1-8 bit, 1-WDT	USB 2.0, AUSART	48	8 MHz 32 kHz	PBOR/ PLVD	3	1/0	✓	Full-Speed USB 2.0 Compliant
PIC18F2455	256/128	✓	256	2048	23	28SP, 28SO	11x10-bit 100 kcps	2	3-16 bit, 1-8 bit, 1-WDT	USB 2.0, MI <sup>2</sup> C/SPI, EUSART	48	8 MHz 32 kHz	PBOR/ PLVD	3	2/0	✓	Full-Speed USB 2.0 Compliant
PIC18F2480	16/8	✓	256	768	25	28SP, 28SO, 28ML	8x10-bit 100 kcps	—	3-16 bit, 1-8 bit, 1-WDT	CAN 2.0B, MI <sup>2</sup> C/SPI, EUSART	40	8 MHz 32 kHz	PBOR/ PLVD	3	1/0	✓	ECAN™ technology
PIC18F2510	32/16	—	—	1536	25	28SP, 28SO, 28ML	10x10-bit 100 kcps	2	3-16 bit, 1-8 bit, 1-WDT	EUSART, MI <sup>2</sup> C/SPI	40	8 MHz 32 kHz	PBOR/ PLVD	3	2/0	✓	
PIC18F2520	32/16	✓	256	1536	25	28SP, 28SO, 28ML	10x10-bit 100 kcps	2	3-16 bit, 1-8 bit, 1-WDT	EUSART, MI <sup>2</sup> C/SPI	40	8 MHz 32 kHz	PBOR/ PLVD	3	2/0	✓	
PIC18F2523*	32/16	✓	256	1536	25	28SP, 28SO, 28ML	10x10-bit 100 kcps	2	3-16 bit, 1-8 bit, 1-WDT	EUSART, MI <sup>2</sup> C/SPI	32	8 MHz 32 kHz	PBOR/ PLVD	3	2/0	✓	VDD = 2.7V-3.6V
PIC18F2515	48/24	—	—	3968	25	28SP, 28SO	10x10-bit 100 kcps	2	3-16 bit, 1-8 bit, 1-WDT	EUSART, MI <sup>2</sup> C/SPI	40	8 MHz 32 kHz	PBOR/ PLVD	3	2/0	✓	

\*Contact Microchip Technology for availability date. Abbreviations are found on the last page of the Selector Guide.

**NEW**

High-Performance 8-Bit PICmicro® Microcontroller Family (16-Bit Instruction Word) (continued)

Product	Program Memory (Kbytes/ K words)	Self-Write	Data EEPROM (Bytes)	RAM (Bytes)	I/O Pins	Packages	Analog		Digital		Max. Speed MHz	IntOSC	BOR/ PBOR/ PLVD	ICD # of Breakpoints	CCP/ ECCP	nW	Other Features
							ADC Ch	Comp.	Timers/WDT	Serial I/O							
PIC18 Flash MCUs: 10 MIPS, V <sub>DD</sub> = 2.0V-5.5V, Upwardly Compatible with PIC16C, 77 Instructions, C Compiler Efficient Instruction Set (continued)																	
PIC18F2525	48/24	✓	1024	3968	25	28SP, 28SO	10x10-bit 100 ksps	2	3-16 bit, 1-8 bit, 1-WDT	EUSART, M <sup>2</sup> C/SPI	40	8 MHz 32 kHz	PBOR/ PLVD	3	2/0	✓	
PIC18F2550	32/16	✓	256	2048	23	28SP, 28SO	11x10-bit 100 ksps	2	3-16 bit, 1-8 bit, 1-WDT	USB 2.0, M <sup>2</sup> C/SPI, EUSART	48	8 MHz 32 kHz	PBOR/ PLVD	3	2/0	✓	Full-Speed USB 2.0 Compliant
PIC18F2580	32/16	✓	256	1536	25	28SP, 28SO, 28ML	8x10-bit 100 ksps	—	3-16 bit, 1-8 bit, 1-WDT	CAN 2.0B, M <sup>2</sup> C/SPI, EUSART	40	8 MHz 32 kHz	PBOR/ PLVD	3	1/0	✓	ECAN™ technology
PIC18F2585	48/24	✓	1024	3328	25	28SP, 28SO	8x10-bit 100 ksps	—	3-16 bit, 1-8 bit, 1-WDT	EUSART, M <sup>2</sup> C/SPI	40	8 MHz 32 kHz	PBOR/ PLVD	3	1/0	✓	ECAN™ technology
PIC18F2610	64/32	—	—	3968	25	28SP, 28SO	10x10-bit 100 ksps	2	3-16 bit, 1-8 bit, 1-WDT	EUSART, M <sup>2</sup> C/SPI	40	8 MHz 32 kHz	PBOR/ PLVD	3	2/0	✓	
PIC18F2620	64/32	✓	1024	3968	25	28SP, 28SO	10x10-bit 100 ksps	2	3-16 bit, 1-8 bit, 1-WDT	EUSART, M <sup>2</sup> C/SPI	40	8 MHz 32 kHz	PBOR/ PLVD	3	2/0	✓	
PIC18F2680	64/32	✓	1024	3328	25	28SP, 28SO	8x10-bit 100 ksps	—	3-16 bit, 1-8 bit, 1-WDT	CAN 2.0B, M <sup>2</sup> C/SPI, EUSART	40	8 MHz 32 kHz	PBOR/ PLVD	3	1/0	✓	ECAN™ technology
PIC18F2682*	80/40	✓	1024	3328	25	28SP, 28SO	8x10-bit 100 ksps	—	3-16 bit, 1-8 bit, 1-WDT	CAN 2.0B, M <sup>2</sup> C/SPI, EUSART	40	8 MHz 32 kHz	PBOR/ PLVD	3	1/0	✓	ECAN™ technology
PIC18F2685*	96/48	✓	1024	3328	25	28SP, 28SO	8x10-bit 100 ksps	—	3-16 bit, 1-8 bit, 1-WDT	CAN 2.0B, M <sup>2</sup> C/SPI, EUSART	40	8 MHz 32 kHz	PBOR/ PLVD	3	1/0	✓	ECAN™ technology
PIC18F4220	4/2	✓	256	512	36	40P, 44ML, 44PT	13x10-bit 30 ksps	2	3-16 bit, 1-8 bit, 1-WDT	AUSART, M <sup>2</sup> C/SPI	40	8 MHz 32 kHz	PBOR/ PLVD	1	1/1	✓	PSP
PIC18F4221*	4/2	✓	256	512	36	40P, 44ML, 44PT	13x10-bit 100 ksps	2	3-16 bit, 1-8 bit, 1-WDT	EUSART, M <sup>2</sup> C/SPI	40	8 MHz 32 kHz	PBOR/ PLVD	3	1/1	✓	PSP
PIC18F4320	8/4	✓	256	512	36	40P, 44ML, 44PT	13x10-bit 100 ksps	2	3-16 bit, 1-8 bit, 1-WDT	AUSART, M <sup>2</sup> C/SPI	40	8 MHz 32 kHz	PBOR/ PLVD	1	1/1	✓	PSP
PIC18F4321*	8/4	✓	256	512	36	40P, 44ML, 44PT	13x10-bit 100 ksps	2	3-16 bit, 1-8 bit, 1-WDT	EUSART, M <sup>2</sup> C/SPI	40	8 MHz 32 kHz	PBOR/ PLVD	3	1/1	✓	PSP
PIC18F4331	8/4	✓	256	768	36	40P, 44ML, 44PT	9x10-bit 200 ksps	—	3-16 bit, 1-8 bit, 1-WDT	EUSART, I <sup>2</sup> C/SPI	40	8 MHz 32 kHz	PBOR/ PLVD	1	2/0	✓	8-channel 14-bit Motor Control PWMs, 2-ch Quadrature Encoder
PIC18F4410	16/8	—	—	768	36	40P, 44ML, 44PT	13x12-bit 100 ksps	2	3-16 bit, 1-8 bit, 1-WDT	EUSART, M <sup>2</sup> C/SPI	40	8 MHz 32 kHz	PBOR/ PLVD	3	1/1	✓	PSP
PIC18F4420	16/8	✓	256	768	36	40P, 44ML, 44PT	13x12-bit 100 ksps	2	3-16 bit, 1-8 bit, 1-WDT	EUSART, M <sup>2</sup> C/SPI	40	8 MHz 32 kHz	PBOR/ PLVD	3	1/1	✓	PSP
PIC18F4423*	16/8	✓	256	768	36	40P, 44ML, 44PT	13x12-bit 100 ksps	2	3-16 bit, 1-8 bit, 1-WDT	EUSART, M <sup>2</sup> C/SPI	32	8 MHz 32 kHz	PBOR/ PLVD	3	1/1	✓	V <sub>DD</sub> = 2.7V-3.6V, PSP
PIC18F4431	16/8	✓	256	768	36	40P, 44ML, 44PT	9x10-bit 200 ksps	—	3-16 bit, 1-8 bit, 1-WDT	EUSART, I <sup>2</sup> C/SPI	40	8 MHz 32 kHz	PBOR/ PLVD	1	2/0	✓	8-channel 14-bit Motor Control PWMs, 2-ch Quadrature Encoder

\*Contact Microchip Technology for availability date. Abbreviations are found on the last page of the Selector Guide.

NEW

NEW

### High-Performance 8-Bit PICmicro® Microcontroller Family (16-Bit Instruction Word) (continued)

Product	Program Memory (Kbytes/ K words)	Self-Write	Data EEPROM (Bytes)	RAM (Bytes)	I/O Pins	Packages	Analog		Digital		Max. Speed MHz	IntOSC	BOR/ PBOR/ PLVD	ICD # of Breakpoints	CCP/ ECCP	nW	Other Features
							ADC Ch	Comp.	Timers/WDT	Serial I/O							
<b>PIC18 Flash MCUs: 10 MIPS, V<sub>DD</sub> = 2.0V-5.5V, Upwardly Compatible with PIC16C, 77 Instructions, C Compiler Efficient Instruction Set (continued)</b>																	
PIC18F4450	16/8	✓	—	768	34	40P, 44ML, 44PT	13x10-bit 100 kspcs	—	2-16 bit, 1-8 bit, 1-WDT	USB 2.0, AUSART	48	8 MHz 32 kHz	PBOR/ PLVD	3	1/0	✓	Full-Speed USB 2.0 Compliant
PIC18F4455	24/12	✓	256	2048	34	40P, 44ML, 44PT	13x10-bit 100 kspcs	2	3-16 bit, 1-8 bit, 1-WDT	USB 2.0, M <sup>2</sup> C/SPI, EUSART	48	8 MHz 32 kHz	PBOR/ PLVD	3	1/1	✓	Full-Speed USB 2.0 Compliant, Streaming Port
PIC18F4480	16/8	✓	256	768	36	40P, 44ML, 44PT	11x10-bit 100 kspcs	2	3-16 bit, 1-8 bit, 1-WDT	CAN 2.0B, M <sup>2</sup> C/SPI, EUSART	40	8 MHz 32 kHz	PBOR/ PLVD	3	1/1	✓	ECAN™ technology
PIC18F4510	32/16	—	—	1536	36	40P, 44ML, 44PT	13x10-bit 100 kspcs	2	3-16 bit, 1-8 bit, 1-WDT	EUSART, M <sup>2</sup> C/SPI	40	8 MHz 32 kHz	PBOR/ PLVD	3	1/1	✓	PSP
PIC18F4520	32/16	✓	256	1536	36	40P, 44ML, 44PT	13x10-bit 100 kspcs	2	3-16 bit, 1-8 bit, 1-WDT	EUSART, M <sup>2</sup> C/SPI	40	8 MHz 32 kHz	PBOR/ PLVD	3	1/1	✓	PSP
PIC18F4523*	32/16	✓	256	1536	36	40P, 44ML, 44PT	13x12-bit 100 kspcs	2	3-16 bit, 1-8 bit, 1-WDT	EUSART, M <sup>2</sup> C/SPI	32	8 MHz 32 kHz	PBOR/ PLVD	3	1/1	✓	V <sub>DD</sub> = 2.7V-3.6V, PSP
PIC18F4515	48/24	—	—	3968	36	40P, 44ML, 44PT	13x10-bit 100 kspcs	2	3-16 bit, 1-8 bit, 1-WDT	EUSART, M <sup>2</sup> C/SPI	40	8 MHz 32 kHz	PBOR/ PLVD	3	1/1	✓	PSP
PIC18F4525	48/24	✓	1024	3968	36	40P, 44ML, 44PT	13x10-bit 100 kspcs	2	3-16 bit, 1-8 bit, 1-WDT	EUSART, M <sup>2</sup> C/SPI	40	8 MHz 32 kHz	PBOR/ PLVD	3	1/1	✓	PSP
PIC18F4550	32/16	✓	256	2048	34	40P, 44ML, 44PT	13x10-bit 100 kspcs	2	3-16 bit, 1-8 bit, 1-WDT	USB 2.0, M <sup>2</sup> C/SPI, EUSART	48	8 MHz 32 kHz	PBOR/ PLVD	3	1/1	✓	Full-Speed USB 2.0 Compliant, Streaming Port
PIC18F4580	32/16	✓	256	1536	36	40P, 44ML, 44PT	11x10-bit 100 kspcs	2	3-16 bit, 1-8 bit, 1-WDT	CAN 2.0B, M <sup>2</sup> C/SPI, EUSART	40	8 MHz 32 kHz	PBOR/ PLVD	3	1/1	✓	ECAN™ technology
PIC18F4585	48/24	✓	1024	3328	36	40P, 44ML, 44PT	11x10-bit 100 kspcs	2	3-16 bit, 1-8 bit, 1-WDT	CAN 2.0B, M <sup>2</sup> C/SPI, EUSART	40	8 MHz 32 kHz	PBOR/ PLVD	3	1/1	✓	ECAN™ technology
PIC18F4610	64/32	—	—	3968	36	40P, 44ML, 44PT	13x10-bit 100 kspcs	2	3-16 bit, 1-8 bit, 1-WDT	EUSART, M <sup>2</sup> C/SPI	40	8 MHz 32 kHz	PBOR/ PLVD	3	1/1	✓	PSP
PIC18F4620	64/32	✓	1024	3968	36	40P, 44ML, 44PT	13x10-bit 100 kspcs	2	3-16 bit, 1-8 bit, 1-WDT	EUSART, M <sup>2</sup> C/SPI	40	8 MHz 32 kHz	PBOR/ PLVD	3	1/1	✓	PSP
PIC18F4680	64/32	✓	1024	3328	36	40P, 44ML, 44PT	11x10-bit 100 kspcs	2	3-16 bit, 1-8 bit, 1-WDT	CAN 2.0B, M <sup>2</sup> C/SPI, EUSART	40	8 MHz 32 kHz	PBOR/ PLVD	3	1/1	✓	ECAN™ technology
PIC18F4682*	80/40	✓	1024	3328	36	40P, 44ML, 44PT	11x10-bit 100 kspcs	2	3-16 bit, 1-8 bit, 1-WDT	CAN 2.0B, M <sup>2</sup> C/SPI, EUSART	40	8 MHz 32 kHz	PBOR/ PLVD	3	1/1	✓	ECAN™ technology
PIC18F4685*	96/48	✓	1024	3328	36	40P, 44ML, 44PT	11x10-bit 100 kspcs	2	3-16 bit, 1-8 bit, 1-WDT	CAN 2.0B, M <sup>2</sup> C/SPI, EUSART	40	8 MHz 32 kHz	PBOR/ PLVD	3	1/1	✓	ECAN™ technology
PIC18F6310	8/4	—	—	768	54	64PT	12x10-bit 100 kspcs	2	3-16 bit, 1-8 bit, 1-WDT	M <sup>2</sup> C/SPI, EUSART, AUSART	40	8 MHz 32 kHz	PBOR/ PLVD	3	3/0	3	EMA

\*Contact Microchip Technology for availability date. Abbreviations are found on the last page of the Selector Guide.

**NEW**

**NEW**

**NEW**

**High-Performance 8-Bit PICmicro® Microcontroller Family (16-Bit Instruction Word) (continued)**

Product	Program Memory (Kbytes/ K words)	Self-Write	Data EEPROM (Bytes)	RAM (Bytes)	I/O Pins	Packages	Analog		Digital		Max. Speed MHz	IntOSC	BOR/ PBOR/ PLVD	ICD # of Breakpoints	CCP/ ECCP	nW	Other Features
							ADC Ch	Comp.	Timers/WDT	Serial I/O							
<b>PIC18 Flash MCUs: 10 MIPS, V<sub>DD</sub> = 2.0V-5.5V, Upwardly Compatible with PIC16C, 77 Instructions, C Compiler Efficient Instruction Set (continued)</b>																	
PIC18F6410	16/8	—	—	768	54	64PT	12x10-bit 100 kspcs	2	3-16 bit, 1-8 bit, 1-WDT	M <sup>2</sup> C/SPI, EUSART, AUSART	40	8 MHz 32 kHz	PBOR/ PLVD	3	3/0	✓	EMA
PIC18F6390	8/4	—	—	768	50	64PT	12x10-bit 100 kspcs	2	3-16 bit, 1-8 bit, 1-WDT	M <sup>2</sup> C/SPI, EUSART, AUSART	40	8 MHz 32 kHz	PBOR/ PLVD	3	2/0	✓	LCD: up to 128 Segments
PIC18F6490	16/8	—	—	768	50	64PT	12x10-bit 100 kspcs	2	3-16 bit, 1-8 bit, 1-WDT	M <sup>2</sup> C/SPI, EUSART, AUSART	40	8 MHz 32 kHz	PBOR/ PLVD	3	2/0	✓	LCD: up to 128 Segments
PIC18F6520	32/16	✓	1024	2048	52	64PT	12x10-bit 100 kspcs	2	3-16 bit, 2-8 bit, 1-WDT	2xAUSART, M <sup>2</sup> C/SPI	40	—	PBOR/ PLVD	1	5/0	—	PSP
PIC18F6527	48/24	✓	1024	3936	54	64PT	12x10-bit 100 kspcs	2	3-16 bit, 2-8 bit, 1-WDT	2XEUSART, 2xM <sup>2</sup> C/SPI	40	8 MHz 32 kHz	PBOR/ PLVD	3	2/3	✓	PSP
PIC18F6585	48/24	✓	1024	3328	53	64PT, 68L	12x10-bit 100 kspcs	2	3-16 bit, 1-8 bit, 1-WDT	EUSART, M <sup>2</sup> C/SPI, CAN 2.0B	40	—	PBOR/ PLVD	1	1/1	—	ECAN™ technology
PIC18F6622	64/32	✓	1024	3936	54	64PT	12x10-bit 100 kspcs	2	3-16 bit, 2-8 bit, 1-WDT	2XEUSART, 2xM <sup>2</sup> C/SPI	40	8 MHz 32 kHz	PBOR/ PLVD	3	2/3	✓	PSP
PIC18F6627	96/48	✓	1024	3936	54	64PT	12x10-bit 100 kspcs	2	3-16 bit, 2-8 bit, 1-WDT	2XEUSART, 2xM <sup>2</sup> C/SPI	40	8 MHz 32 kHz	PBOR/ PLVD	3	2/3	✓	PSP
PIC18F6680	64/32	✓	1024	3328	53	64PT, 68L	12x10-bit 100 kspcs	2	3-16 bit, 1-8 bit, 1-WDT	EUSART, M <sup>2</sup> C/SPI, CAN 2.0B	40	—	PBOR/ PLVD	1	1/1	—	ECAN™ technology
PIC18F6722	128/64	✓	1024	3936	54	64PT	12x10-bit 100 kspcs	2	3-16 bit, 2-8 bit, 1-WDT	2XEUSART, 2xM <sup>2</sup> C/SPI	40	8 MHz 32 kHz	PBOR/ PLVD	3	2/3	✓	PSP
PIC18F8310	8/4	—	—	768	70	80PT	12x10-bit 100 kspcs	2	3-16 bit, 1-8 bit, 1-WDT	M <sup>2</sup> C/SPI, EUSART, AUSART	40	8 MHz 32 kHz	PBOR/ PLVD	3	3/0	✓	EMA
PIC18F8410	16/8	—	—	768	70	80PT	12x10-bit 100 kspcs	2	3-16 bit, 2-8 bit, 1-WDT	M <sup>2</sup> C/SPI, EUSART, AUSART	40	8 MHz 32 kHz	PBOR/ PLVD	3	3/0	✓	EMA
PIC18F8390	8/4	—	—	768	66	80PT	12x10-bit 100 kspcs	2	3-16 bit, 1-8 bit, 1-WDT	M <sup>2</sup> C/SPI, EUSART, AUSART	40	8 MHz 32 kHz	PBOR/ PLVD	3	2/0	✓	LCD: up to 192 Segments
PIC18F8490	16/8	—	—	768	66	80PT	12x10-bit 100 kspcs	2	3-16 bit, 2-8 bit, 1-WDT	M <sup>2</sup> C/SPI, EUSART, AUSART	40	8 MHz 32 kHz	PBOR/ PLVD	3	2/0	✓	LCD: up to 192 Segments
PIC18F8520	32/16	✓	1024	2048	68	80PT	16x10-bit 30 kspcs	2	2-8 bit, 3-16 bit, 1-WDT	2xAUSART, M <sup>2</sup> C/SPI	40	—	PBOR/ PLVD	1	5/0	—	PSP, EMA
PIC18F8527	48/24	✓	1024	3936	70	80PT	16x10-bit 30 kspcs	2	3-16 bit, 2-8 bit, 1-WDT	2XEUSART, 2xM <sup>2</sup> C/SPI	40	8 MHz 32 kHz	PBOR/ PLVD	3	2/3	✓	PSP, EMA
PIC18F8585	48/24	✓	1024	3328	69	80PT	16x10-bit 30 kspcs	2	3-16 bit, 1-8 bit, 1-WDT	EUSART, M <sup>2</sup> C/SPI, CAN 2.0B	40	—	PBOR/ PLVD	1	1/1	—	ECAN™ technology, EMA
PIC18F8622	64/32	✓	1024	3936	70	80PT	16x10-bit 30 kspcs	2	3-16 bit, 2-8 bit, 1-WDT	2XEUSART, 2xM <sup>2</sup> C/SPI	40	8 MHz 32 kHz	PBOR/ PLVD	3	2/3	✓	PSP, EMA

\*Contact Microchip Technology for availability date. Abbreviations are found on the last page of the Selector Guide.

### High-Performance 8-Bit PICmicro® Microcontroller Family (16-Bit Instruction Word) (continued)

Product	Program Memory (Kbytes/ K words)	Self-Write	Data EEPROM (Bytes)	RAM (Bytes)	I/O Pins	Packages	Analog		Digital		Max. Speed MHz	IntOSC	BOR/ PBOR/ PLVD	ICD # of Breakpoints	CCP/ ECCP	nW	Other Features
							ADC Ch	Comp.	Timers/WDT	Serial I/O							
<b>PIC18 Flash MCUs: 10 MIPS, V<sub>DD</sub> = 2.0V-5.5V, Upwardly Compatible with PIC16C, 77 Instructions, C Compiler Efficient Instruction Set (continued)</b>																	
PIC18F8627	96/48	✓	1024	3936	70	80PT	16x10-bit 30 kspcs	2	3-16 bit, 2-8 bit, 1-WDT	2xEUSART, 2xMI <sup>2</sup> C/SPI	40	8 MHz 32 kHz	PBOR/ PLVD	3	2/3	✓	PSP, EMA
PIC18F8680	64/32	✓	1024	3328	69	80PT	16x10-bit 30 kspcs	2	3-16 bit, 1-8 bit, 1-WDT	EUSART, MI <sup>2</sup> C/SPI, CAN 2.0B	40	—	PBOR/ PLVD	1	1/1	—	ECANTM technology, EMA
PIC18F8722	128/64	✓	1024	3936	70	80PT	16x10-bit 100 kspcs	2	3-16 bit, 2-8 bit, 1-WDT	2xEUSART, 2xMI <sup>2</sup> C/SPI	40	8 MHz 32 kHz	PBOR/ PLVD	3	2/3	✓	PSP, EMA
<b>PIC18FXXJXX Flash MCUs: 10 MIPS, V<sub>DD</sub> = 2.0V-3.6V, Upwardly Compatible with PIC18/PIC16, 77 Instructions, C Compiler Efficient Instruction Set</b>																	
PIC18F24J10	16/8	✓	—	1024	21	28SP, 28SO, 28SS, 28ML	10x10-bit 100 kspcs	2	2-16 bit, 1-8 bit, 1-WDT	EUSART, MI <sup>2</sup> C/SPI	40	32 kHz	BOR	3	2/0	✓	
PIC18F25J10	32/16	✓	—	1024	21	28SP, 28SO, 28SS, 28ML	10x10-bit 100 kspcs	2	2-16 bit, 1-8 bit, 1-WDT	EUSART, MI <sup>2</sup> C/SPI	40	32 kHz	BOR	3	2/0	✓	
PIC18F44J10	16/8	✓	—	1024	32	40P, 44ML, 44PT	13x10-bit 100 kspcs	2	2-16 bit, 1-8 bit, 1-WDT	EUSART, 2xMI <sup>2</sup> C/SPI	40	32 kHz	BOR	3	1/1	✓	PSP
PIC18F45J10	32/16	✓	—	1024	32	40P, 44ML, 44PT	13x10-bit 100 kspcs	2	2-16 bit, 1-8 bit, 1-WDT	EUSART, 2xMI <sup>2</sup> C/SPI	40	32 kHz	BOR	3	1/1	✓	PSP
PIC18F63J11*	8/4	✓	—	1024	54	64PT	12x10-bit 100 kspcs	2	3-16 bit, 1-8 bit, 1-WDT	AUSART, EUSART, MI <sup>2</sup> C/SPI	40	8 MHz 32 kHz	BOR, LVD	3	2/0	✓	
PIC18F63J90*	8/4	✓	—	1024	50	64PT	12x10-bit 100 kspcs	2	3-16 bit, 1-8 bit, 1-WDT	AUSART, EUSART, MI <sup>2</sup> C/SPI	40	8 MHz 32 kHz	BOR, LVD	3	2/0	✓	LCD: up to 132 Segments
PIC18F64J11*	16/8	✓	—	1024	54	64PT	12x10-bit 100 kspcs	2	3-16 bit, 1-8 bit, 1-WDT	AUSART, EUSART, MI <sup>2</sup> C/SPI	40	8 MHz 32 kHz	BOR, LVD	3	2/0	✓	
PIC18F64J90*	16/8	✓	—	1024	50	64PT	12x10-bit 100 kspcs	2	3-16 bit, 1-8 bit, 1-WDT	AUSART, EUSART, MI <sup>2</sup> C/SPI	40	8 MHz 32 kHz	BOR, LVD	3	2/0	✓	LCD: up to 132 Segments
PIC18F65J10	32/16	✓	—	2048	50	64PT	11x10-bit 100 kspcs	2	3-16 bit, 2-8 bit, 1-WDT	2xEUSART, 2xMI <sup>2</sup> C/SPI	40	32 kHz	BOR	3	2/3	✓	PSP
PIC18F65J11*	32/16	✓	—	2048	54	64PT	12x10-bit 100 kspcs	2	3-16 bit, 1-8 bit, 1-WDT	AUSART, EUSART, MI <sup>2</sup> C/SPI	40	8 MHz 32 kHz	BOR, LVD	3	2/0	✓	
PIC18F65J15	48/24	✓	—	2048	50	64PT	11x10-bit 100 kspcs	2	3-16 bit, 2-8 bit, 1-WDT	2xEUSART, 2xMI <sup>2</sup> C/SPI	40	32 kHz	BOR	3	2/3	✓	PSP
PIC18F65J90*	32/16	✓	—	2048	50	64PT	12x10-bit 100 kspcs	2	3-16 bit, 1-8 bit, 1-WDT	AUSART, EUSART, MI <sup>2</sup> C/SPI	40	8 MHz 32 kHz	BOR, LVD	3	2/0	✓	LCD: up to 132 Segments
PIC18F66J10	64/32	✓	—	2048	50	64PT	11x10-bit 100 kspcs	2	3-16 bit, 2-8 bit, 1-WDT	2xEUSART, 2xMI <sup>2</sup> C/SPI	40	32 kHz	BOR	3	2/3	✓	PSP
PIC18F66J60*	64/32	✓	—	3808	39	64PT	11x10-bit 100 kspcs	2	3-16 bit, 2-8 bit, 1-WDT	EUSART, MI <sup>2</sup> C/SPI	42	32 kHz	BOR	3	2/3	✓	10Base-T Ethernet
PIC18F66J15	96/48	✓	—	3936	50	64PT	11x10-bit 100 kspcs	2	3-16 bit, 2-8 bit, 1-WDT	2xEUSART, 2xMI <sup>2</sup> C/SPI	40	32 kHz	BOR	3	2/3	✓	PSP

\*Contact Microchip Technology for availability date. Abbreviations are found on the last page of the Selector Guide.

High-Performance 8-Bit PICmicro® Microcontroller Family (16-Bit Instruction Word) (continued)

Product	Program Memory (Kbytes/ K words)	Self-Write	Data EEPROM (Bytes)	RAM (Bytes)	I/O Pins	Packages	Analog		Digital		Max. Speed MHz	IntOSC	BOR/ PBOR/ PLVD	ICD # of Breakpoints	CCP/ ECCP	nW	Other Features
							ADC Ch	Comp.	Timers/WDT	Serial I/O							
PIC18FXXJXX Flash MCUs: 10 MIPS, V <sub>DD</sub> = 2.0V-3.6V, Upwardly Compatible with PIC18PIC16; 77 Instructions, C Compiler Efficient Instruction Set (continued)																	
PIC18F66J65*	96/48	✓	—	3808	39	64PT	11x10-bit 100 kspcs	2	3-16 bit, 2-8 bit, 1-WDT	EUSART, M <sup>2</sup> C/SPI	42	32 kHz	BOR	3	2/3	✓	10Base-T Ethernet
PIC18F67J10	128/64	✓	—	3936	50	64PT	11x10-bit 100 kspcs	2	3-16 bit, 2-8 bit, 1-WDT	2xEUSART, 2xM <sup>2</sup> C/SPI	40	32 kHz	BOR	3	2/3	✓	PSP
PIC18F67J60*	128/64	✓	—	3808	39	64PT	11x10-bit 100 kspcs	2	3-16 bit, 2-8 bit, 1-WDT	EUSART, M <sup>2</sup> C/SPI	42	32 kHz	BOR	3	2/3	✓	10Base-T Ethernet
PIC18F83J11*	8/4	✓	—	1024	70	80PT	12x10-bit 100 kspcs	2	3-16 bit, 1-8 bit, 1-WDT	AUSART, EUSART, M <sup>2</sup> C/SPI	40	8 MHz 32 kHz	BOR, LVD	3	2/0	✓	PSP
PIC18F83J90*	8/4	✓	—	1024	66	80PT	12x10-bit 100 kspcs	2	3-16 bit, 1-8 bit, 1-WDT	AUSART, EUSART, M <sup>2</sup> C/SPI	40	8 MHz 32 kHz	BOR, LVD	3	2/0	✓	LCD: up to 192 Segments
PIC18F84J11*	16/8	✓	—	1024	70	80PT	12x10-bit 100 kspcs	2	3-16 bit, 1-8 bit, 1-WDT	AUSART, EUSART, M <sup>2</sup> C/SPI	40	8 MHz 32 kHz	BOR, LVD	3	2/0	✓	PSP
PIC18F84J90*	16/8	✓	—	1024	66	80PT	12x10-bit 100 kspcs	2	3-16 bit, 1-8 bit, 1-WDT	AUSART, EUSART, M <sup>2</sup> C/SPI	40	8 MHz 32 kHz	BOR, LVD	3	2/0	✓	LCD: up to 192 Segments
PIC18F85J10	32/16	✓	—	2048	66	80PT	15x10-bit 100 kspcs	2	3-16 bit, 2-8 bit, 1-WDT	2xEUSART, 2xM <sup>2</sup> C/SPI	40	32 kHz	BOR	3	2/3	✓	PSP, EMA
PIC18F85J11*	32/16	✓	—	2048	70	80PT	12x10-bit 100 kspcs	2	3-16 bit, 1-8 bit, 1-WDT	AUSART, EUSART, M <sup>2</sup> C/SPI	40	8 MHz 32 kHz	BOR, LVD	3	2/0	✓	PSP
PIC18F85J15	48/24	✓	—	2048	66	80PT	15x10-bit 100 kspcs	2	3-16 bit, 2-8 bit, 1-WDT	2xEUSART, 2xM <sup>2</sup> C/SPI	40	32 kHz	BOR	3	2/3	✓	PSP, EMA
PIC18F85J90*	32/16	✓	—	2048	66	80PT	12x10-bit 100 kspcs	2	3-16 bit, 1-8 bit, 1-WDT	AUSART, EUSART, M <sup>2</sup> C/SPI	40	8 MHz 32 kHz	BOR, LVD	3	2/0	✓	LCD: up to 192 Segments
PIC18F86J10	64/32	✓	—	2048	66	80PT	15x10-bit 100 kspcs	2	3-16 bit, 2-8 bit, 1-WDT	2xEUSART, 2xM <sup>2</sup> C/SPI	40	32 kHz	BOR	3	2/3	✓	PSP, EMA
PIC18F86J60*	64/32	✓	—	3808	55	80PT	15x10-bit 100 kspcs	2	3-16 bit, 2-8 bit, 1-WDT	2xEUSART, M <sup>2</sup> C/SPI	42	32 kHz	BOR	3	2/3	✓	10Base-T Ethernet
PIC18F86J15	96/48	✓	—	3936	66	80PT	15x10-bit 100 kspcs	2	3-16 bit, 2-8 bit, 1-WDT	2xEUSART, 2xM <sup>2</sup> C/SPI	40	32 kHz	BOR	3	2/3	✓	PSP, EMA
PIC18F86J65*	96/48	✓	—	3808	55	80PT	15x10-bit 100 kspcs	2	3-16 bit, 2-8 bit, 1-WDT	2xEUSART, M <sup>2</sup> C/SPI	42	32 kHz	BOR	3	2/3	✓	10Base-T Ethernet
PIC18F87J10	128/64	✓	—	3936	66	80PT	15x10-bit 100 kspcs	2	3-16 bit, 2-8 bit, 1-WDT	2xEUSART, 2xM <sup>2</sup> C/SPI	40	32 kHz	BOR	3	2/3	✓	PSP, EMA
PIC18F87J60*	128/64	✓	—	3808	55	80PT	15x10-bit 100 kspcs	2	3-16 bit, 2-8 bit, 1-WDT	2xEUSART, M <sup>2</sup> C/SPI	42	32 kHz	BOR	3	2/3	✓	10Base-T Ethernet
PIC18F96J60*	64/32	✓	—	3808	70	100PT	16x10-bit 100 kspcs	2	3-16 bit, 2-8 bit, 1-WDT	2xEUSART, 2xM <sup>2</sup> C/SPI	42	32 kHz	BOR	3	2/3	✓	PSP, EMA, 10Base-T Ethernet
PIC18F96J65*	96/48	✓	—	3808	70	100PT	16x10-bit 100 kspcs	2	3-16 bit, 2-8 bit, 1-WDT	2xEUSART, 2xM <sup>2</sup> C/SPI	42	32 kHz	BOR	3	2/3	✓	PSP, EMA, 10Base-T Ethernet
PIC18F97J60*	128/64	✓	—	3808	70	100PT	16x10-bit 100 kspcs	2	3-16 bit, 2-8 bit, 1-WDT	2xEUSART, 2xM <sup>2</sup> C/SPI	42	32 kHz	BOR	3	2/3	✓	PSP, EMA, 10Base-T Ethernet

\*Contact Microchip Technology for availability date. Abbreviations are found on the last page of the Selector Guide.



# FUTURE PICmicro® MICROCONTROLLER FAMILY PRODUCTS

## Mid-Range 8-Bit PICmicro® Microcontroller Family (14-Bit Instruction Word)

Product	Program Memory (Kbytes/ K words)	Self-Write	Data EEPROM (Bytes)	RAM (Bytes)	I/O Pins	Packages	Analog		Digital		Max. Speed MHz	IntOSC	BOR/ PBOR/ PLVD	ICD # of Breakpoints	CCP/ ECCP	nW	Other Features
							ADC Channels	Comp.	Timers/WDT	Serial I/O							
<b>PIC12FXXX: 200 ns Instruction Execution, 35 Instructions, 25 mA Source and Sink per I/O</b>																	
PIC12F609	1.75/1	—	—	64	6	8P, 8SN, 8MD, 8MS	—	1	1-16 bit, 1-8 bit, 1-WDT	—	20	8 MHz	BOR	1**	—	—	High-Voltage Option with Internal Shunt Regulator
PIC12F615	1.75/1	—	—	64	6	8P, 8SN, 8MD, 8MS	4x10-bit	1	1-16 bit, 2-8 bit, 1-WDT	—	20	8 MHz	BOR	1**	0/1	—	High-Voltage Option with Internal Shunt Regulator
<b>PIC16FXXX: 200 ns Instruction Execution, 35 Instructions, ICSPTM, 25 mA Source and Sink per I/O</b>																	
PIC16F610	1.75/1	—	—	72	12	14P, 14SL, 14ST, 16ML	—	2	1-16 bit, 2-8 bit, 1-WDT	—	20	8 MHz	BOR	1**	—	—	High-Voltage Option with Internal Shunt Regulator, SR-Latch
PIC16F722	3.5/2	—	—	128	25	28SP, 28SO, 28SS, 28ML	11x8-bit	—	1-16 bit, 2-8 bit, 1-EWDT	—	20	8 MHz	BOR	1**	1/0	—	1.8V-5.5V operation Program Memory Read
PIC16F723	7/4	—	—	192	25	28SP, 28SO, 28SS, 28ML	11x8-bit	—	1-16 bit, 2-8 bit, 1-EWDT	—	20	8 MHz	BOR	1**	2/0	—	1.8V-5.5V operation Program Memory Read
PIC16F724	7/4	—	—	192	36	40P, 44PT, 44ML	14x8-bit	—	1-16 bit, 2-8 bit, 1-EWDT	—	20	8 MHz	BOR	1**	2/0	—	1.8V-5.5V operation Program Memory Read
PIC16F726	14/8	—	—	368	25	28SP, 28SO, 28SS, 28ML	11x8-bit	—	1-16 bit, 2-8 bit, 1-EWDT	—	20	8 MHz	BOR	1**	2/0	—	1.8V-5.5V operation Program Memory Read
PIC16F727	14/8	—	—	368	36	40P, 44PT, 44ML	14x8-bit	—	1-16 bit, 2-8 bit, 1-EWDT	—	20	8 MHz	BOR	1**	2/0	—	1.8V-5.5V operation Program Memory Read
PIC16F882	3.5/2	✓	128	128	25	28SP, 28SO, 28SS, 28ML	11x10-bit	2	1-16 bit, 2-8 bit, 1-EWDT	EUSART, I <sup>2</sup> C/SPI	20	8 MHz 32 kHz	BOR	1	1/1	✓	SR-Latch
<b>PIC16CRXX: 200 ns Instruction Execution, 35 Instructions, 25 mA Source and Sink per I/O</b>																	
PIC16CR73	7/4	—	—	192	22	28SP, 28SO, 28SS, 28ML	5x8-bit	—	1-16 bit, 2-8 bit, 1-WDT	USART, I <sup>2</sup> C/SPI	20	—	BOR	—	2/0	—	—
PIC16CR74	7/4	—	—	192	33	40P, 44ML, 44L, 44PT	8x8-bit	—	1-16 bit, 2-8 bit, 1-WDT	USART, I <sup>2</sup> C/SPI	20	—	BOR	—	2/0	—	PSP
PIC16CR76	14/8	—	—	368	22	28SP, 28SO, 28SS, 28ML	5x8-bit	—	1-16 bit, 2-8 bit, 1-WDT	USART, I <sup>2</sup> C/SPI	20	—	BOR	—	2/0	—	—
PIC16CR77	14/8	—	—	368	33	40P, 44ML, 44L, 44PT	8x8-bit	—	1-16 bit, 2-8 bit, 1-WDT	USART, I <sup>2</sup> C/SPI	20	—	BOR	—	2/0	—	PSP

\*\* Requires ICD specific device with header module – refer to Development Tools. Abbreviations are found on the last page of the Selector Guide.

**High-Performance 8-Bit PICmicro® Microcontroller Family (16-Bit Instruction Word)**

Product	Program Memory (Kbytes/ K words)	Self-Write	Data EEPROM (Bytes)	RAM (Bytes)	I/O Pins	Packages	Analog		Digital		Max. Speed MHz	IntOSC	BOR/ PLVD	ICD # of Breakpoints	CCP/ ECCP	nW	Other Features
							ADC Channels	Comp.	Timers/WDT	Serial I/O							
<b>PIC18FXX: Upwardly Compatible with PIC16, 77 Instructions, C Compiler Efficient Instruction Set, Software Stack Capability, Table Read/Write, Switchable Oscillator Sources, 4x PLL, 10-12 MIPS, ICSP™</b>																	
PIC18F6522	32/16	✓	1024	2048	54	64PT	12x10-bit 100 ksp	2	3-16 bit, 2-8 bit, 1-WDT	2xEUSART, 2xMI <sup>2</sup> C/SPI	40	8 MHz 32 kHz	PBOR	3	2/3	✓	PSP
PIC18F6493	16/8	—	—	768	50	64PT	12x12-bit 100 ksp	2	3-16 bit, 1-8 bit, 1-WDT	MI <sup>2</sup> C/SPI, EUSART, AUSART	32	8 MHz 32 kHz	PBOR/ PLVD	3	2/0	✓	LCD: up to 132 Segments
PIC18F8493	16/8	—	—	768	66	80PT	12x12-bit 100 ksp	2	3-16 bit, 2-8 bit, 1-WDT	MI <sup>2</sup> C/SPI, EUSART, AUSART	32	8 MHz 32 kHz	PBOR/ PLVD	3	2/0	✓	LCD: up to 192 Segments
PIC18F8522	32/16	✓	1024	2048	70	80PT	16x10-bit 100 ksp	2	3-16 bit, 2-8 bit, 1-WDT	2xEUSART, 2xMI <sup>2</sup> C/SPI	40	8 MHz 32 kHz	PBOR	3	2/3	✓	PSP, EMA
<b>PIC18FXXJXX: Flash and ROM MCUs: 10 MIPS, V<sub>DD</sub> = 2.0V-3.6V, Upwardly Compatible with PIC18/PIC16, 77 Instructions and C Compiler Efficient Instruction Set</b>																	
PIC18F24J11	16/8	✓	—	2048	21	28SP, 28SO, 28SS, 28ML	10x10-bit 100 ksp	2	3-16 bit, 2-8 bit, 1-WDT	2xEUSART, 2xMI <sup>2</sup> C/SPI	48	8 MHz 32 kHz	PBOR/ LVD	3	0/2	✓	Peripheral remapping capability (cross bar), PMP
PIC18F25J11	32/16	✓	—	2048	21	28SP, 28SO, 28SS, 28ML	10x10-bit 100 ksp	2	3-16 bit, 2-8 bit, 1-WDT	2xEUSART, 2xMI <sup>2</sup> C/SPI	48	8 MHz 32 kHz	PBOR/ LVD	3	0/2	✓	Peripheral remapping capability (cross bar), PMP
PIC18F25J16	48/24	✓	—	3936	21	28SP, 28SO, 28SS, 28ML	10x10-bit 100 ksp	2	3-16 bit, 2-8 bit, 1-WDT	2xEUSART, 2xMI <sup>2</sup> C/SPI	48	8 MHz 32 kHz	PBOR/ LVD	3	0/2	✓	Peripheral remapping capability (cross bar), PMP
PIC18F26J11	64/32	✓	—	3936	21	28SP, 28SO, 28SS, 28ML	10x10-bit 100 ksp	2	3-16 bit, 2-8 bit, 1-WDT	2xEUSART, 2xMI <sup>2</sup> C/SPI	48	8 MHz 32 kHz	PBOR/ LVD	3	0/2	✓	Peripheral remapping capability (cross bar), PMP
PIC18F44J11	16/8	✓	—	2048	32	40P, 44PT, 44ML	13x10-bit 100 ksp	2	3-16 bit, 2-8 bit, 1-WDT	2xEUSART, 2xMI <sup>2</sup> C/SPI	48	8 MHz 32 kHz	PBOR/ LVD	3	0/2	✓	Peripheral remapping capability (cross bar), PMP
PIC18F45J11	32/16	✓	—	2048	32	40P, 44PT, 44ML	13x10-bit 100 ksp	2	3-16 bit, 2-8 bit, 1-WDT	2xEUSART, 2xMI <sup>2</sup> C/SPI	48	8 MHz 32 kHz	PBOR/ LVD	3	0/2	✓	Peripheral remapping capability (cross bar), PMP
PIC18F45J16	48/24	✓	—	3936	32	40P, 44PT, 44ML	13x10-bit 100 ksp	2	3-16 bit, 2-8 bit, 1-WDT	2xEUSART, 2xMI <sup>2</sup> C/SPI	48	8 MHz 32 kHz	PBOR/ LVD	3	0/2	✓	Peripheral remapping capability (cross bar), PMP
PIC18F46J11	64/32	✓	—	3936	32	40P, 44PT, 44ML	13x10-bit 100 ksp	2	3-16 bit, 2-8 bit, 1-WDT	2xEUSART, 2xMI <sup>2</sup> C/SPI	48	8 MHz 32 kHz	PBOR/ LVD	3	0/2	✓	Peripheral remapping capability (cross bar), PMP
PIC18F65J50	32/16	✓	—	3904	50	64PT	8x10-bit 100 ksp	2	3-16 bit, 2-8 bit, 1-WDT	USB 2.0, 2xEUSART, 2xMI <sup>2</sup> C/SPI	48	8 MHz 32 kHz	BOR, LVD	3	2/3	✓	Full-Speed USB 2.0 Compliant PMP
PIC18R65J10	32/16	✓	—	2048	50	64PT	11x10-bit, 100 ksp	2	3-16 bit, 2-8 bit, 1-WDT	2xEUSART, 2xMI <sup>2</sup> C/SPI	40	32 kHz	BOR	3	2/3	✓	PSP
PIC18R66J10	64/32	✓	—	2048	50	64PT	11x10-bit 100 ksp	2	3-16 bit, 2-8 bit, 1-WDT	2xEUSART, 2xMI <sup>2</sup> C/SPI	40	32 kHz	BOR	3	2/3	✓	PSP
PIC18F66J11	64/32	✓	—	3904	50	64PT	8x10-bit 100 ksp	2	3-16 bit, 2-8 bit, 1-WDT	2xEUSART, 2xMI <sup>2</sup> C/SPI	48	8 MHz 32 kHz	BOR, LVD	3	2/3	✓	PMP
PIC18F66J50	64/32	✓	—	3904	50	64PT	8x10-bit 100 ksp	2	3-16 bit, 2-8 bit, 1-WDT	USB 2.0, 2xEUSART, 2xMI <sup>2</sup> C/SPI	48	8 MHz 32 kHz	BOR, LVD	3	2/3	✓	Full-Speed USB 2.0 Compliant PMP
PIC18R67J10	128/64	✓	—	3936	50	64PT	11x10-bit, 100 ksp	2	3-16 bit, 2-8 bit, 1-WDT	2xEUSART, 2xMI <sup>2</sup> C/SPI	40	32 kHz	BOR	3	2/3	✓	PSP
PIC18F67J11	128/64	✓	—	3904	50	64PT	8x10-bit 100 ksp	2	3-16 bit, 2-8 bit, 1-WDT	2xMI <sup>2</sup> C/SPI	48	8 MHz 32 kHz	BOR, LVD	3	2/3	✓	PMP

Abbreviations are found on the last page of the Selector Guide.

### High-Performance 8-Bit PICmicro® Microcontroller Family (16-Bit Instruction Word) (continued)

Product	Program Memory (Kbytes/ K words)	Self-Write	Data EEPROM (Bytes)	RAM (Bytes)	I/O Pins	Packages	Analog		Digital		Max. Speed MHz	IntOSC	BOR/ PBOR/ PLVD	ICD # of Breakpoints	CCP/ ECCP	nW	Other Features
							ADC Channels	Comp.	Timers/WDT	Serial I/O							
<b>PIC18FXXJXX: Flash and ROM MCUs: 10 MIPS, V<sub>DD</sub> = 2.0V-3.6V, Upwardly Compatible with PIC18/PIC16, 77 Instructions and C Compiler Efficient Instruction Set (continued)</b>																	
PIC18F67J50	128/64	✓	—	3904	50	64PT	8x10-bit 100 ksp	2	3-16 bit, 2-8 bit, 1-WDT	USB 2.0, 2xEUSART, 2xMI <sup>2</sup> C/SPI	48	8 MHz 32 kHz	BOR, LVD	3	2/3	✓	Full-Speed USB 2.0 Compliant PMP, EMA
PIC18F85J50	32/16	✓	—	3904	66	80PT	12x10-bit 100 ksp	2	3-16 bit, 2-8 bit, 1-WDT	USB 2.0, 2xEUSART, 2xMI <sup>2</sup> C/SPI	48	8 MHz 32 kHz	BOR/ LVD	3	2/3	✓	Full-Speed USB 2.0 Compliant PMP, EMA
PIC18R85J10	32/16	✓	—	2048	66	80PT	15x10-bit 100 ksp	2	3-16 bit, 2-8 bit, 1-WDT	2xEUSART, 2xMI <sup>2</sup> C/SPI	40	32 kHz	BOR	3	2/3	✓	PSP, EMA
PIC18R86J10	64/32	✓	—	2048	66	80PT	15x10-bit, 100 ksp	2	3-16 bit, 2-8 bit, 1-WDT	2xEUSART, 2xMI <sup>2</sup> C/SPI	40	32 kHz	BOR	3	2/3	✓	PSP, EMA
PIC18F86J11	64/32	✓	—	3904	66	80PT	12x10-bit 100 ksp	2	3-16 bit, 2-8 bit, 1-WDT	2xEUSART, 2xMI <sup>2</sup> C/SPI	48	8 MHz 32 kHz	BOR, LVD	3	2/3	✓	PMP, EMA
PIC18F86J50	64/32	✓	—	3904	66	80PT	12x10-bit 100 ksp	2	3-16 bit, 2-8 bit, 1-WDT	USB 2.0, 2xEUSART, 2xMI <sup>2</sup> C/SPI	48	8 MHz 32 kHz	BOR, LVD	3	2/3	✓	Full-Speed USB 2.0 Compliant PMP, EMA
PIC18R87J10	128/64	✓	—	3936	66	80PT	15x10-bit, 100 ksp	2	3-16 bit, 2-8 bit, 1-WDT	2xEUSART, 2xMI <sup>2</sup> C/SPI	40	32 kHz	BOR	3	2/3	✓	PSP, EMA
PIC18F87J11	128/64	✓	—	3904	66	80PT	12x10-bit 100 ksp	2	3-16 bit, 2-8 bit, 1-WDT	2xEUSART, 2xMI <sup>2</sup> C/SPI	48	8 MHz 32 kHz	BOR, LVD	3	2/3	✓	PMP, EMA
PIC18F87J50	128/64	✓	—	3904	66	80PT	12x10-bit, 100 ksp	2	3-16 bit, 2-8 bit, 1-WDT	USB 2.0, 2xEUSART, 2xMI <sup>2</sup> C/SPI	48	8 MHz 32 kHz	BOR, LVD	3	2/3	✓	Full-Speed USB 2.0 Compliant PMP, EMA
<b>PIC18FXXKXX Flash MCUs: 16 MIPS, V<sub>DD</sub> = 1.8V-3.6V</b>																	
PIC18F23K20	8/4	✓	256	768	25	28SP, 28SO, 28SS, 28ML	10x10 bit 100 ksp	2	3-16 bit, 1-8 bit, 1-WDT	EUSART, MI <sup>2</sup> C/SPI	64	16 MHz 32 kHz	PBOR/ PLVD	3	1/1	✓	
PIC18F24K20	16/8	✓	256	768	25	28SP, 28SO, 28SS, 28ML	10x10 bit 100 ksp	2	3-16 bit, 1-8 bit, 1-WDT	EUSART, MI <sup>2</sup> C/SPI	64	16 MHz 32 kHz	PBOR/ PLVD	3	1/1	✓	
PIC18F25K20	32/16	✓	256	1536	25	28SP, 28SO, 28SS, 28ML	11x10 bit 100 ksp	2	3-16 bit, 1-8 bit, 1-WDT	EUSART, MI <sup>2</sup> C/SPI	64	16 MHz 32 kHz	PBOR/ PLVD	3	1/1	✓	
PIC18F26K20	64/32	✓	1024	3968	25	28SP, 28SO, 28SS, 28ML	11x10 bit 100 ksp	2	3-16 bit, 1-8 bit, 1-WDT	EUSART, MI <sup>2</sup> C/SPI	64	16 MHz 32 kHz	PBOR/ PLVD	3	1/1	✓	
PIC18F43K20	8/4	✓	256	768	36	40P, 44ML, 44PT	13x10 bit 100 ksp	2	3-16 bit, 1-8 bit, 1-WDT	EUSART, MI <sup>2</sup> C/SPI	64	16 MHz 32 kHz	PBOR/ PLVD	3	1/1	✓	PSP
PIC18F44K20	16/8	✓	256	768	36	40P, 44ML, 44PT	13x10 bit 100 ksp	2	3-16 bit, 1-8 bit, 1-WDT	EUSART, MI <sup>2</sup> C/SPI	64	16 MHz 32 kHz	PBOR/ PLVD	3	1/1	✓	PSP
PIC18F45K20	32/16	✓	256	1536	36	40P, 44ML, 44PT	14x10 bit 100 ksp	2	3-16 bit, 1-8 bit, 1-WDT	EUSART, MI <sup>2</sup> C/SPI	64	16 MHz 32 kHz	PBOR/ PLVD	3	1/1	✓	PSP
PIC18F46K20	64/32	✓	1024	3968	36	40P, 44ML, 44PT	14x10 bit 100 ksp	2	3-16 bit, 1-8 bit, 1-WDT	EUSART, MI <sup>2</sup> C/SPI	64	16 MHz 32 kHz	PBOR/ PLVD	3	1/1	✓	PSP

Abbreviations are found on the last page of the Selector Guide.

# MATURE – PICmicro® MCU AND dsPIC® DSC FAMILY PRODUCTS

Not recommended for new designs.  
Please use a device from the recommended column for new designs.

Product	Program Memory (Bytes/Words)	Pin Count	Recommended Design-In Device	Product	Program Memory (Bytes/Words)	Pin Count	Recommended Design-In Device
PIC12C508	768/12x12	8	PIC12F508	PIC16C715	3,584/2,048x14	18	PIC16F716
PIC12C508A	768/12x12	8	PIC12F508	PIC16C716	3,584/2,048x14	18	PIC16F716
PIC12C509	1,536/1,024x12	8	PIC12F509	PIC16C73A	7,168/4,096x14	28	PIC16F73
PIC12C509A	1,536/1,024x12	8	PIC12F509	PIC16C73B	7,168/4,096x14	28	PIC16F73
PIC12C671	1,536/1,024x14	8	PIC12F675	PIC16C74A	7,168/4,096x14	40	PIC16F74
PIC12C672	3,584/2,048x14	8	PIC12F683	PIC16C74B	7,168/4,096x14	40	PIC16F74
PIC12CE673	1,792/1,024x14	8	PIC12F675	PIC16C745	14,336/8,192x14	28	PIC18F4450
PIC12CE674	3,584/2,048x14	8	PIC12F683	PIC16C76	14,336/8,192x14	28	PIC16F76
PIC12CE518	768/12x12	8	PIC12F629	PIC16C77	14,336/8,192x14	40	PIC16F77
PIC12CE519	1,536/1,024x12	8	PIC12F629	PIC16C923	7,168/4,096x14	68	PIC16C925
PIC12CR509A	1,536/1,024x12	8	PIC12F509	PIC16C924	7,168/4,096x14	68	PIC16C925
PIC16C505	1,536/1,024x12	14	PIC16F505	PIC16CE623	896/512x14	18	PIC16F627A
PIC16C54	768/12x12	18	PIC16F54	PIC16CE625	1,792/1,024x14	18	PIC16F627A
PIC16C54A	768/12x12	18	PIC16F54	PIC16CE625	3,584/2,048x14	18	PIC16F628A
PIC16C54C	768/12x12	18	PIC16F54	PIC16CR54A	768/512x12	18	PIC16CR54C
PIC16C55	768/12x12	28	PIC16C55A	PIC16CR54C	768/512x12	18	PIC16F54
PIC16C56	1,536/1,024x12	18	PIC16C56A	PIC16CR57C	3,072/2,048x12	28	PIC16F57
PIC16C57	3,072/2,048x12	28	PIC16F57	PIC16CR83	896/512x14	18	PIC16F84A
PIC16C57C	3,072/2,048x12	28	PIC16F57	PIC16CR84	1,792/1,024x14	18	PIC16F84A
PIC16C62A	3,584/2,048x14	28	PIC16C62B or PIC16F72	PIC16F827	1,792/1,024x14	18	PIC16F627A
PIC16C620	896/2,048x14	18	PIC16C620A	PIC16F828	3,584/2,048x14	18	PIC16F628A
PIC16C621	1,792/1,024x14	18	PIC16C621A	PIC16F83	896/512x14	18	PIC16F84A
PIC16C622	3,584/2,048x14	18	PIC16C622A	PIC16F84	1,792/1,024x14	18	PIC16F84A
PIC16C63	7,168/4,096x14	28	PIC16C63B or PIC16F73	PIC16F873	7,168/4,096x14	28	PIC16F873A
PIC16C64	3,584/2,048x14	40	PIC16F74	PIC16F874	7,168/4,096x14	28	PIC16F874A
PIC16C642	7,168/4,096x14	28	PIC16F72	PIC16F876	14,336/8,192x14	40	PIC16F876A
PIC16C65A	7,168/4,096x14	40	PIC16C65B or PIC16F74	PIC16F877	14,336/8,192x14	40	PIC16F877A
PIC16C66	1,4336/8,192x14	28	PIC16F76	PIC17C42A	4,096/2,048x16	40	PIC18F4220
PIC16C662	7,168/4,096x14	40	PIC16F74	PIC17C43	8,192/4,096x16	40	PIC18F4320
PIC16C67	14,336/8,192x14	40	PIC16F77	PIC17C44	16,384/8,192x16	40	PIC18F4420
PIC16C71	1,792/1,024x14	18	PIC16F716	PIC17C752	16,384/8,192x16	68	PIC18F6520
PIC16C72	3,584/2,048x14	28	PIC16F72	PIC17C756A	32,768/16,384x16	68	PIC18F6520
PIC16C72A	3,584/2,048x14	28	PIC16F72	PIC17C762	16,384/8,192x16	84	PIC18F8520
PIC16C710	896/512x14	18	PIC16F716	PIC17C766	32,768/16,384x16	84	PIC18F8520
PIC16C711	1,792/1,024x14	18	PIC16F716	PIC18C242	16,384/8,192x16	28	PIC18F2420
PIC16C712	1,792/1,024x14	18	PIC16F716	PIC18C252	32,768/16,384x16	28	PIC18F2520

Product	Program Memory (Bytes/Words)	Pin Count	Recommended Design-In Device
PIC18C442	16,384/8,192x16	40	PIC18F4420
PIC18C452	32,768/16,384x16	40	PIC18F4520
PIC18C658	32,768/16,384x16	68	PIC18F6585
PIC18C858	32,768/16,384x16	84	PIC18F8585
PIC18F242	16,384/8,192x16	28	PIC18F2420
PIC18F248	16,384/8,192x16	28	PIC18F2480
PIC18F252	32,768/16,384x16	28	PIC18F2520
PIC18F258	32,768/16,384x16	28	PIC18F2580
PIC18F442	16,384/8,192x16	40	PIC18F4420
PIC18F448	16,384/8,192x16	40	PIC18F4480
PIC18F452	32,768/16,384x16	40	PIC18F4520
PIC18F458	32,768/16,384x16	40	PIC18F4580
PIC18F2439	12,288/6,144x16	28	PIC18F2431
PIC18F2539	24,576/12,288x16	28	PIC18F2431
PIC18F4439	12,288/6,144x16	40	PIC18F4431

Product	Program Memory (Bytes/Words)	Pin Count	Recommended Design-In Device
PIC18F4539	24,576/12,288x16	40	PIC18F4431
PIC18F6525	49,152/24,576x16	64	PIC18F6527
PIC18F6620	65,536/32,768x16	64	PIC18F6622
PIC18F6621	65,536/32,768x16	64	PIC18F6622
PIC18F6720	131,072/65,536x16	64	PIC18F6722
PIC18F8525	49,152/24,576x16	80	PIC18F8527
PIC18F8620	65,536/32,768x16	80	PIC18F8622
PIC18F8621	65,536/32,768x16	80	PIC18F8622
PIC18F8720	131,072/65,536x16	80	PIC18F8722
dsPIC30F6010	144K/48K	80	dsPIC30F6010A
dsPIC30F6011	132K/44K	64	dsPIC30F6011A
dsPIC30F6012	144K/48K	64	dsPIC30F6012A
dsPIC30F6013	132K/44K	80	dsPIC30F6013A
dsPIC30F6014	144K/48K	80	dsPIC30F6014A

# FOCUSED SOLUTIONS

CAN Solutions ([www.microchip.com/can](http://www.microchip.com/can))

Product	Program Memory (Kbytes/ K words)	Self-Write	Data EEPROM (Bytes)	RAM (Bytes)	I/O Pins	Packages	Analog Peripherals	Digital Peripherals	Max. Speed MHz	ICD # of Breakpoints	ISO-16845 Tested	Function-Specific Features			Development Boards	
												Transmit Buffers	Receive Buffers	Configurable RX/TX		Acceptance Filters/ Mask
PIC18F2480	16/8	✓	256	768	25	28SP, 28SO, 28ML	ADC	EUSART, CCP, Mi <sup>2</sup> C/SPI	40	3	Planned	3	2	6	16/2	DM163011 PICDEM™ CAN-LIN 2
PIC18F2580	32/16	✓	256	1536	25	28SP, 28SO, 28ML	ADC	EUSART, CCP, Mi <sup>2</sup> C/SPI	40	3	Planned	3	2	6	16/2	DM163011 PICDEM™ CAN-LIN 2
PIC18F2585	48/24	✓	1024	3328	25	28SP, 28SO	ADC	EUSART, CCP, Mi <sup>2</sup> C/SPI	40	3	Planned	3	2	6	16/2	DM163011 PICDEM™ CAN-LIN 2
PIC18F2680	64/32	✓	1024	3328	25	28SP, 28SO	ADC	EUSART, CCP, Mi <sup>2</sup> C/SPI	40	3	Planned	3	2	6	16/2	DM163011 PICDEM™ CAN-LIN 2
PIC18F2682*	80/40	✓	1024	3328	25	28SP, 28SO	ADC	EUSART, CCP, Mi <sup>2</sup> C/SPI	40	3	Planned	3	2	6	16/2	DM163011 PICDEM™ CAN-LIN 2
PIC18F2685*	96/48	✓	1024	3328	25	28SP, 28SO	ADC	EUSART, CCP, Mi <sup>2</sup> C/SPI	40	3	Planned	3	2	6	16/2	DM163011 PICDEM™ CAN-LIN 2
PIC18F4480	16/8	✓	256	768	36	40P, 44PT, 44ML	ADC/Comp	EUSART, CCP/ECCP, Mi <sup>2</sup> C/SPI	40	3	Planned	3	2	6	16/2	DM163011 PICDEM™ CAN-LIN 2
PIC18F4580	32/16	✓	256	1536	36	40P, 44PT, 44ML	ADC/Comp	EUSART, CCP/ECCP, Mi <sup>2</sup> C/SPI	40	3	Planned	3	2	6	16/2	DM163011 PICDEM™ CAN-LIN 2
PIC18F4585	48/24	✓	1024	3328	36	40P, 44PT, 44ML	ADC/Comp	EUSART, CCP/ECCP, Mi <sup>2</sup> C/SPI	40	3	Planned	3	2	6	16/2	DM163011 PICDEM™ CAN-LIN 2
PIC18F4680	64/32	✓	1024	3328	36	40P, 44PT, 44ML	ADC/Comp	EUSART, CCP/ECCP, Mi <sup>2</sup> C/SPI	40	3	Planned	3	2	6	16/2	DM163011 PICDEM™ CAN-LIN 2
PIC18F4682*	80/40	✓	1024	3328	36	40P, 44PT, 44ML	ADC/Comp	EUSART, CCP/ECCP, Mi <sup>2</sup> C/SPI	40	3	Planned	3	2	6	16/2	DM163011 PICDEM™ CAN-LIN 2
PIC18F4685*	96/48	✓	1024	3328	36	40P, 44PT, 44ML	ADC/Comp	EUSART, CCP/ECCP, Mi <sup>2</sup> C/SPI	40	3	Planned	3	2	6	16/2	DM163011 PICDEM™ CAN-LIN 2
PIC18F6585	48/24	✓	1024	3328	53	64PT, 68L	ADC/Comp	EUSART, CCP/ECCP, Mi <sup>2</sup> C/SPI	40	1	Yes	3	2	6	16/2	DM163015 PICDEM™ CAN-LIN 3
PIC18F6680	64/32	✓	1024	3328	53	64PT, 68L	ADC/Comp	EUSART, CCP/ECCP, Mi <sup>2</sup> C/SPI	40	1	Yes	3	2	6	16/2	DM163015 PICDEM™ CAN-LIN 3
PIC18F8585	48/24	✓	1024	3328	69	80PT	ADC/Comp	EUSART, CCP/ECCP, Mi <sup>2</sup> C/SPI	40	1	Yes	3	2	6	16/2	DM163015 PICDEM™ CAN-LIN 3
PIC18F8680	64/32	✓	1024	3328	69	80PT	ADC/Comp	EUSART, CCP/ECCP, Mi <sup>2</sup> C/SPI	40	1	Yes	3	2	6	16/2	DM163015 PICDEM™ CAN-LIN 3
dsPIC30F4011	48/16	✓	1024	2048	30	40P, 44PT, 44ML (8x8)	ADC	CAN, SPI, I <sup>2</sup> C, 2xUART	120	1	Yes	3	2	0	4/2	DM300018 dsPICDEM™ 2

NEW

NEW

NEW

NEW

\* Contact Microchip Technology Inc. for availability. Refer to Connectivity Design Center on [www.microchip.com/can](http://www.microchip.com/can) for further details. Abbreviations are found on the last page of the Selector Guide.

**CAN Solutions (www.microchip.com/can) (continued)**

Product	Program Memory (Kbytes/ K words)	Self-Write	Data EEPROM (Bytes)	RAM (Bytes)	I/O Pins	Packages	Analog Peripherals	Digital Peripherals	Max. Speed MHz	ICD # of Breakpoints	Function-Specific Features				Development Boards	
											ISO-16845 Tested	Transmit Buffers	Receive Buffers	Configurable RX/TX		Acceptance Filters/ Mask
dsPIC30F4012	48/16	✓	1024	2048	20	28SP, 28SO, 44ML (8x8)	ADC	CAN, SPI, I <sup>2</sup> C, 2xUART	120	1	Yes	3	2	0	4/2	DM300018 dsPICDEM™ 2
dsPIC30F4013	48/16	✓	1024	2048	30	40P, 44PT, 44ML (8x8)	ADC	CAN, SPI, I <sup>2</sup> C, 2xUART	120	1	Yes	3	2	0	4/2	DM300018 dsPICDEM™ 2
dsPIC30F5011	66/22	✓	1024	4096	52	64PT	ADC	2xCAN, 2xSPI, I <sup>2</sup> C, 2xUART	120	2	Yes	3	2	0	4/2	DM300014 dsPICDEM™ 1.1
dsPIC30F5013	66/22	✓	1024	4096	68	80PT	ADC	2xCAN, 2xSPI, I <sup>2</sup> C, 2xUART	120	2	Yes	3	2	0	4/2	DM300014 dsPICDEM™ 1.1
dsPIC30F5015	66/22	✓	1024	2048	52	64PT	ADC	CAN, UART, 2xSPI, I <sup>2</sup> C	120	2	Yes	3	2	0	4/2	DM300020
dsPIC30F5016	66/22	✓	1024	2048	68	80PT	ADC	CAN, UART, 2xSPI, I <sup>2</sup> C	120	2	Yes	3	2	0	4/2	DM300020
dsPIC30F6010A	144/48	✓	4096	8192	68	80PF, 80PT	ADC	2xCAN, 2xSPI, I <sup>2</sup> C, 2xUART	120	2	Yes	3	2	0	4/2	DM300020
dsPIC30F6011A	132/44	✓	2048	6144	52	64PF, 64PT	ADC	2xCAN, 2xSPI, I <sup>2</sup> C, 2xUART	120	2	Yes	3	2	0	4/2	DM300014 dsPICDEM™ 1.1
dsPIC30F6012A	144/48	✓	4096	8192	52	64PF, 64PT	ADC	2xCAN, 2xSPI, I <sup>2</sup> C, 2xUART	120	2	Yes	3	2	0	4/2	DM300014 dsPICDEM™ 1.1
dsPIC30F6013A	132/44	✓	2048	6144	68	80PF, 80PT	ADC	2xCAN, 2xSPI, I <sup>2</sup> C, 2xUART	120	2	Yes	3	2	0	4/2	DM300014 dsPICDEM™ 1.1
dsPIC30F6014A	144/48	✓	4096	8192	68	80PF, 80PT	ADC	2xCAN, 2xSPI, I <sup>2</sup> C, 2xUART	120	2	Yes	3	2	0	4/2	DM300014 dsPICDEM™ 1.1
dsPIC30F6015	144/48	✓	4096	8192	52	64PT	ADC	2xCAN, 2xSPI, I <sup>2</sup> C, 2xUART	120	2	Yes	3	2	0	4/2	DM300014 dsPICDEM™ 1.1
dsPIC33FJ64MC506*	64/21	✓	—	8192	53	64PT	10/12-bit ADC	1xECAN, 2xSPI, 2xI <sup>2</sup> C, 2xUART	160	4	Planned	8 max	32 max	8	16/3	DM240001
dsPIC33FJ64MC508	64/21	✓	—	8192	69	80PT	10/12-bit ADC	1xECAN, 2xSPI, 2xI <sup>2</sup> C, 2xUART	160	4	Planned	8 max	32 max	8	16/3	DM240001
dsPIC33FJ64MC510*	64/21	✓	—	8192	85	100PT, 100PF	10/12-bit ADC	1xECAN, 2xSPI, 2xI <sup>2</sup> C, 2xUART	160	4	Planned	8 max	32 max	8	16/3	DM240001
dsPIC33FJ64MC706	64/21	✓	—	16K	53	64PT	10/12-bit ADC	1xECAN, 2xSPI, 2xI <sup>2</sup> C, 2xUART	160	4	Planned	8 max	32 max	8	16/3	DM240001
dsPIC33FJ64MC710	64/21	✓	—	16K	53	100PT, 100PF	10/12-bit ADC	2xECAN, 2xSPI, 2xI <sup>2</sup> C, 2xUART	160	4	Planned	16 max	64 max	16	32/6	DM240001
dsPIC33FJ128MC506*	128/43	✓	—	8192	53	64PT	10/12-bit ADC	1xECAN, 2xSPI, 2xI <sup>2</sup> C, 2xUART	160	4	Planned	8 max	16 max	8	16/3	DM240001
dsPIC33FJ128MC706	128/43	✓	—	16K	53	64PT	10/12-bit ADC	1xECAN, 2xSPI, 2xI <sup>2</sup> C, 2xUART	160	4	Planned	8 max	32 max	8	16/3	DM240001
dsPIC33FJ128MC708	128/43	✓	—	16K	69	80PT	10/12-bit ADC	2xECAN, 2xSPI, 2xI <sup>2</sup> C, 2xUART	160	4	Planned	16 max	64 max	16	32/6	DM240001
dsPIC33FJ128MC710*	128/43	✓	—	16K	85	100PT, 100PF	10/12-bit ADC	2xECAN, 2xSPI, 2xI <sup>2</sup> C, 2xUART	160	4	Planned	16 max	64 max	16	32/6	DM240001

\* Contact Microchip Technology Inc. for availability. Refer to Connectivity Design Center on [www.microchip.com/can](http://www.microchip.com/can) for further details. Abbreviations are found on the last page of the Selector Guide.

**NEW**

**NEW**

**NEW**

**NEW**

**NEW**

**NEW**

**NEW**

**NEW**

**NEW**

**NEW**

**NEW**

**CAN Solutions (www.microchip.com/can) (continued)**

Product	Program Memory (Kbytes/ K words)	Self-Write	Data EEPROM (Bytes)	RAM (Bytes)	I/O Pins	Packages	Analog Peripherals	Digital Peripherals	Max. Speed MHz	ICD # of Breakpoints	Function-Specific Features			Development Boards		
											ISO-16845 Tested	Transmit Buffers	Receive Buffers		Configurable RX/TX	Acceptance Filters/ Mask
<b>NEW</b> dsPIC33FJ256MC710	256/85	✓	—	30K	85	100PT, 100PF	10/12-bit ADC	2xE CAN, 2xSPI, 2xI <sup>2</sup> C 2xUART	160	4	Planned	16 max	64 max	16	32/6	DM240001
<b>NEW</b> dsPIC33FJ64GP706	64/21	✓	—	16K	53	64PT	10/12-bit ADC	2xE CAN, 2xSPI, 2xI <sup>2</sup> C 2xUART	160	4	Planned	16 max	64 max	16	32/6	DM240001
<b>NEW</b> dsPIC33FJ64GP708	64/21	✓	—	16K	69	80PT	10/12-bit ADC	2xE CAN, 2xSPI, 2xI <sup>2</sup> C 2xUART	160	4	Planned	16 max	64 max	16	32/6	DM240001
<b>NEW</b> dsPIC33FJ64GP710	64/21	✓	—	16K	85	100PT, 100PF	10/12-bit ADC	2xE CAN, 2xSPI, 2xI <sup>2</sup> C 2xUART	160	4	Planned	16 max	64 max	16	32/6	DM240001
<b>NEW</b> dsPIC33FJ128GP706	128/43	✓	—	—	53	64PT	10/12-bit ADC	1xE CAN, 2xSPI, 2xI <sup>2</sup> C 2xUART	160	4	Planned	8 max	32 max	8	16/3	DM240001
<b>NEW</b> dsPIC33FJ128GP708	128/43	✓	—	16K	69	80PT	10/12-bit ADC	2xE CAN, 2xSPI, 2xI <sup>2</sup> C 2xUART	160	4	Planned	16 max	64 max	16	32/6	DM240001
<b>NEW</b> dsPIC33FJ128GP710*	128/43	✓	—	—	85	100PT, 100PF	10/12-bit ADC	2xE CAN, 2xSPI, 2xI <sup>2</sup> C 2xUART	160	4	Planned	16 max	64 max	16	32/6	DM240001
<b>NEW</b> dsPIC33FJ256GP506	256/85	✓	—	16K	53	64PT	10/12-bit ADC	1xE CAN, 2xSPI, 2xI <sup>2</sup> C 2xUART	160	4	Planned	8 max	32 max	8	16/3	DM240001
<b>NEW</b> dsPIC33FJ256GP710	256/85	✓	—	30K	85	100PT, 100PF	10/12-bit ADC	2xE CAN, 2xSPI, 2xI <sup>2</sup> C 2xUART	160	4	Planned	16 max	64 max	16	32/6	DM240001
<b>NEW</b> PIC24HJ64GP506*	64/21	✓	—	8192	53	64PT	10/12-bit ADC	1xE CAN, 2xSPI, 2xI <sup>2</sup> C 2xUART	160	4	Planned	8 max	32 max	8	16/3	DM240001
<b>NEW</b> PIC24HJ64GP510*	64/21	✓	—	8192	85	100PT, 100PF	10/12-bit ADC	1xE CAN, 2xSPI, 2xI <sup>2</sup> C 2xUART	160	4	Planned	8 max	32 max	8	16/3	DM240001
<b>NEW</b> PIC24HJ128GP506	128/43	✓	—	8192	53	64PT	10/12-bit ADC	1xE CAN, 2xSPI, 2xI <sup>2</sup> C 2xUART	160	4	Planned	8 max	32 max	8	16/3	DM240001
<b>NEW</b> PIC24HJ128GP510*	128/43	✓	—	8192	85	100PT, 100PF	10/12-bit ADC	1xE CAN, 2xSPI, 2xI <sup>2</sup> C 2xUART	160	4	Planned	8 max	32 max	8	16/3	DM240001
<b>NEW</b> PIC24HJ256GP610	256/85	✓	—	16K	85	100PT, 100PF	10/12-bit ADC	2xE CAN, 2xSPI, 2xI <sup>2</sup> C 2xUART	160	4	Planned	16 max	64 max	16	32/6	DM240001

\* Contact Microchip Technology Inc. for availability. Refer to Connectivity Design Center on [www.microchip.com/can](http://www.microchip.com/can) for further details. Abbreviations are found on the last page of the Selector Guide.

**CAN Solutions (www.microchip.com/can)**

**CAN Peripherals/Transceivers**

Part #	Operating Voltage (V)	Temperature Range (°C)	Tx Buffers	Rx Buffers	Filters	Masks	Interrupt Output	Unique Features	Packages
MCP2515	2.7 to 5.5	-40 to +125	3	2	6	2	Yes	MCP2510 pin compatible upgrade with enhanced features including higher throughput and data byte filtering	18-Pin PDIP, 18-Pin SOIC, 20-Pin TSSOP
MCP25020	2.7 to 5.5	-40 to +125	3	2	2	1	N/A	CAN 2.0B Active I/O Expander. See "Interface Section" of the Analog/Interface Family Products.	14-Pin PDIP, 14-Pin SOIC
MCP25025	2.7 to 5.5	-40 to +85	3	2	2	1	N/A	CAN 2.0B Active I/O Expander. See "Interface Section" of the Analog/Interface Family Products.	14-Pin PDIP, 14-Pin SOIC



### CAN Solutions (www.microchip.com/can) (continued)

#### CAN Peripherals/Transceivers (continued)

Part #	Operating Voltage (V)	Temperature Range (°C)	Tx Buffers	Rx Buffers	Filters	Masks	Interrupt Output	Unique Features	Packages
MCP25050	2.7 to 5.5	-40 to +125	3	2	2	1	N/A	CAN 2.0B Active I/O Expander. See "Interface Section" of the Analog/Interface Family Products.	14-Pin PDIP, 14-Pin SOIC
MCP25055	2.7 to 5.5	-40 to +85	3	2	2	1	N/A	CAN 2.0B Active I/O Expander. See "Interface Section" of the Analog/Interface Family Products.	14-Pin PDIP, 14-Pin SOIC
MCP2551	4.5 to 5.5	-40 to +125	n/a	n/a	n/a	n/a	N/A	CAN 2.0B Active I/O Expander. See "Interface Section" of the Analog/Interface Family Products.	8-Pin PDIP, 8-Pin SOIC

### Ethernet Solutions (www.microchip.com/ethernet)

Product	Program Memory (Kbytes/ K words)	Self-Write (Bytes)	RAM (Bytes)	I/O Pins	Packages	Analog Peripherals	Digital Peripherals	Max. Speed MHz	ICD # of Breakpoints	Function-Specific Features				Development Boards	
										IEEE.802.3 Compliant	MAC	PHY	TX/RX Buffer (Bytes)		Ethernet Voltage Range (V)
PIC18F66J60*	64/32	✓	3808	39	64PT	ADC/Comp	EUSART, 2xCCP/ 3xECCP, MI <sup>2</sup> C/SPI	42	3	Yes	Yes	10Base-T	8192	3.14 to 3.45	
PIC18F66J65*	96/48	✓	3808	39	64PT	ADC/Comp	EUSART, 2xCCP/ 3xECCP, MI <sup>2</sup> C/SPI	42	3	Yes	Yes	10Base-T	8192	3.14 to 3.45	
PIC18F67J60*	128/64	✓	3808	39	64PT	ADC/Comp	EUSART, 2xCCP/ 3xECCP, MI <sup>2</sup> C/SPI	42	3	Yes	Yes	10Base-T	8192	3.14 to 3.45	
PIC18F86J60*	64/32	✓	3808	55	80PT	ADC/Comp	EUSART, 2xCCP/ 3xECCP, MI <sup>2</sup> C/SPI	42	3	Yes	Yes	10Base-T	8192	3.14 to 3.45	
PIC18F86J65*	96/48	✓	3808	55	80PT	ADC/Comp	EUSART, 2xCCP/ 3xECCP, MI <sup>2</sup> C/SPI	42	3	Yes	Yes	10Base-T	8192	3.14 to 3.45	
PIC18F87J60*	128/64	✓	3808	55	80PT	ADC/Comp	EUSART, 2xCCP/ 3xECCP, MI <sup>2</sup> C/SPI	42	3	Yes	Yes	10Base-T	8192	3.14 to 3.45	
PIC18F96J60*	64/32	✓	3808	70	100PT	ADC/Comp	EUSART, 2xCCP/ 3xECCP, MI <sup>2</sup> C/SPI	42	3	Yes	Yes	10Base-T	8192	3.14 to 3.45	
PIC18F96J65*	96/48	✓	3808	70	100PT	ADC/Comp	EUSART, 2xCCP/ 3xECCP, MI <sup>2</sup> C/SPI	42	3	Yes	Yes	10Base-T	8192	3.14 to 3.45	
PIC18F97J60*	128/64	✓	3808	70	100PT	ADC/Comp	EUSART, 2xCCP/ 3xECCP, MI <sup>2</sup> C/SPI	42	3	Yes	Yes	10Base-T	8192	3.14 to 3.45	

#### Ethernet Solutions – Stand-Alone

Product	Program Memory (Kbytes/ K words)	Self-Write (Bytes)	RAM (Bytes)	Interrupts	Packages	LEDs	Serial	Max. Speed MHz	Features	Function-Specific Features				Development Boards	
										IEEE.802.3 Compliant	MAC	PHY	TX/RX Buffer (Bytes)		Ethernet Voltage Range (V)
ENC28J60	—	—	—	2	28SO, 28SS, 28ML	2	SPI	25	Loopback Test modes, auto-polarity	Yes	Yes	10Base-T	8192	3.14 to 3.45	AC164121

\*Contact Microchip Technology Inc. for availability. Refer to Connectivity Design Center on [www.microchip.com/ethernet](http://www.microchip.com/ethernet) for further details. Abbreviations are found on the last page of the Selector Guide.

USB Solutions ([www.microchip.com/usb](http://www.microchip.com/usb))

Product	Program Memory (Kbytes/ K words)	Self-Write	Data EEPROM (Bytes)	RAM (Bytes)	I/O Pins	Packages	Analog Peripherals	Digital Peripherals	Max. Speed MHz	ICD # of Breakpoints	Function-Specific Features				Development Boards
											Compliant	Speed	# of Endpoints	USB Buffer (Bytes)	
PIC16C745	16/8	—	—	256	22	28SP, 28SO, 28JW	ADC	UART	24	—	16	64	—	DM163010 PICDEM™ USB	
PIC16C765	16/8	—	—	256	33	40P, 40JW, 44L, 44PT	ADC	UART	24	—	16	64	—	DM163010 PICDEM™ USB	
PIC18F2450*	16/8	✓	—	768	23	28SP, 28SO, 28ML	ADC	AUSART, CCP	48	3	16	256	—	DM163025 PICDEM™ FS-USB	
PIC18F2455	24/12	✓	256	2048	24	28SP, 28SO	ADC/Comp	EUSART, 2xCCP, MI <sup>2</sup> C/SPI	48	3	16	1024	—	DM163025 PICDEM™ FS-USB	
PIC18F2550	32/16	✓	256	2048	24	28SP, 28SO	ADC/Comp	EUSART, 2xCCP, MI <sup>2</sup> C/SPI	48	3	16	1024	—	DM163025 PICDEM™ FS-USB	
PIC18F4450*	16/8	✓	—	768	34	40P, 44PT, 44ML	ADC	AUSART, CCP	48	3	16	256	—	DM163025 PICDEM™ FS-USB	
PIC18F4455	24/12	✓	256	2048	36	40P, 44PT, 44ML	ADC/Comp	EUSART, MI <sup>2</sup> C/SPI	48	3	16	1024	✓	DM163025 PICDEM™ FS-USB	
PIC18F4550	32/16	✓	256	2048	36	40P, 44PT, 44ML	ADC/Comp	EUSART, 2xCCP, MI <sup>2</sup> C/SPI	48	3	16	1024	✓	DM163025 PICDEM™ FS-USB	
PIC18F65J50*	32/16	✓	—	3904	50	64PT	ADC/Comp	2xEUSART, 2xCCP/3xECCP, 2xMI <sup>2</sup> C/SPI	48	3	16	1024	—		
PIC18F66J50*	64/32	✓	—	3904	50	64PT	ADC/Comp	2xEUSART, 2xCCP/3xECCP, 2xMI <sup>2</sup> C/SPI	48	3	16	1024	—		
PIC18F67J50*	128/64	✓	—	3904	50	64PT	ADC/Comp	2xEUSART, 2xCCP/3xECCP, 2xMI <sup>2</sup> C/SPI	48	3	16	1024	—		
PIC18F85J50*	32/16	✓	—	3904	66	80PT	ADC/Comp	2xEUSART, 2xCCP/3xECCP, 2xMI <sup>2</sup> C/SPI	48	3	16	1024	—		
PIC18F86J50*	64/32	✓	—	3904	66	80PT	ADC/Comp	2xEUSART, 2xCCP/3xECCP, 2xMI <sup>2</sup> C/SPI	48	3	16	1024	—		
PIC18F87J50*	128/64	✓	—	3904	66	80PT	ADC/Comp	2xEUSART, 2xCCP/3xECCP, 2xMI <sup>2</sup> C/SPI	48	3	16	1024	—		

\*Contact Microchip Technology Inc. for availability. Refer to Connectivity Design Center on [www.microchip.com/usb](http://www.microchip.com/usb) for further details. Abbreviations are found on the last page of the Selector Guide.

### USB Battery Chargers

Part #	Mode	Cell Type	# of Cells	Vcc Range (V)	Max. Voltage Regulation (%)	Int/Ext FET	Features	Packages
MCP73853	Linear	Li-Ion/Li-Polymer	1	4.5 to 5.5	±0.5	Int	USB control, Safety charge timers, Temperature monitor, Thermal regulation	16-Pin QFN (4x4)
MCP73855	Linear	Li-Ion/Li-Polymer	1	4.5 to 5.5	±0.5	Int	USB control, Safety charge timers, Thermal regulation	10-Pin DFN (3x3)

### Radio Frequency Solutions (www.microchip.com/rf)

Product	Program Memory (Kbytes/ K words)	Self-Write (Bytes)	Data EEPROM (Bytes)	RAM (Bytes)	I/O Pins	Packages	Analog Peripherals	Digital Peripherals	Max. Speed (MHz)	Function-Specific Specifications				Development Boards
										Modulation	Data Rate (kbps)	Output Power (dBm)	Operating Voltage (V)	
<b>rfPIC® Microcontrollers with UHF RF Transmitter, ICSP™</b>														
rfPIC12C509AF	1.5/1	—	—	41	6	20JW, 20SS	—	1-8 bit Timer, WDT	4	FSK, ASK	40	2	2.5-5.5	310-440
rfPIC12C509AG	1.5/1	—	—	41	6	18JW, 18SO	—	1-8 bit Timer, WDT	4	ASK	40	2	2.5-5.5	310-440
rfPIC12F675F	2/1	—	128	64	6	20SS	4x10-bit A/D, Comp	1-8 bit, 1-16 bit Timer, WDT	20	FSK, ASK	40	10	2.0-5.5	380-450
rfPIC12F675H	2/1	—	128	64	6	20SS	4x10-bit A/D, Comp	1-8 bit, 1-16 bit Timer, WDT	20	FSK, ASK	40	10	2.0-5.5	850-930
rfPIC12F675K	2/1	—	128	64	6	20SS	4x10-bit A/D, Comp	1-8 bit, 1-16 bit Timer, WDT	20	FSK, ASK	40	10	2.0-5.5	290-350

Product	Transmission Code Length Bits	Code Hopping Bits	Programmable Encryption Key Bits	Packages	Protocols	Function Codes	Tunable OSC	CRC	Function-Specific Specifications			Development Boards	
									Modulation	Output Power (dBm)	Operating Voltage (V)		Frequency Range (MHz)
<b>rfHCS KEELoc® Encoders with UHF RF Transmitter</b>													
rfHCS362F	69	32	2 x 64	20SS	PWM, Manchester	4 x 15	3	3	FSK, ASK	2	2.2-5.5	310-440	DM303006 KEELoc® Evaluation Kit II
rfHCS362G	69	32	2 x 64	18SO	PWM, Manchester	4 x 15	3	3	ASK	2	2.2-5.5	310-440	DM303006 KEELoc® Evaluation Kit II

Product	Modulation	Data Rate (kbps)	Frequency Range (MHz)	Sensitivity dBm (FSK)	IF Frequency Range (MHz)	Operating Voltage (V)	Package	Development Boards
rfRXD0420	ASK, FSK, FM	80	300-450	-111	0.455-21.4	2.5-5.5	32LQ	DV164102 rfPIC® Development Kit
rfRXD0920	ASK, FSK, FM	80	800-930	-109	0.455-21.4	2.5-5.5	32LQ	DV164102 rfPIC® Development Kit

Product	Carrier Frequency	Programming	Anticollision	Memory Type	Memory Size	Protocols	Packages	Other
MCRF355	13.56 MHz	Contact/Factory	Yes	R/W	154 bits	ASK Manchester	W, WF, S, P, SN	—
MCRF450	13.56 MHz	Contactless	Yes	R/W	1 Kbit	PPM, ASK Manchester	W, WF, S, P, SN	32-bit unique ID user lock control by block
MCRF452	13.56 MHz	Contactless	Yes	R/W	1 Kbit	PPM, ASK Manchester	W, WF, S, P, SN	Dual 50 pF res cap

Refer to RF Design Center on [www.microchip.com/rf](http://www.microchip.com/rf) for further details. Abbreviations are found on the last page of the Selector Guide.



LCD Solutions ([www.microchip.com/lcd](http://www.microchip.com/lcd))

Product	Program Memory (Kbytes/ K words)	Self-Write	Data EEPROM (Bytes)	RAM (Bytes)	I/O Pins	Packages	Analog Peripherals	Digital Peripherals	Max. Speed MHz	ICD # of Breakpoints	LCD Function-Specific Features					Development Boards
											COMxSegment = # Segments	Drive in Sleep	Software Configurable Driver Pins	Direct Drive	Intl. Charge Pump	
PIC16C925	8/4	—	—	176	52	64PT, 68CL, 68L	ADC	I <sup>2</sup> C/SPI	20	—	4x29 (116)	Yes	No	Yes	Yes	DM163003 PICDEM™ 3 LCD
PIC16C926	16/8	—	—	336	52	64PT, 68CL, 68L	ADC	I <sup>2</sup> C/SPI	20	—	4x29 (116)	Yes	No	Yes	Yes	DM163003 PICDEM™ 3 LCD
PIC16F913	8/4	—	256	256	25	28P, 28SO, 28SS, 28ML	ADC/Comp	AUSART, I <sup>2</sup> C/SPI	20	1	4x15 (60)	Yes	Yes	Yes	No	DS163028 PICDEM™ LCD with MA160011 daughter boards
PIC16F914	8/4	—	256	256	36	40P, 44PT, 44ML	ADC/Comp	AUSART, I <sup>2</sup> C/SPI	20	1	4x24 (96)	Yes	Yes	Yes	No	DS163028 PICDEM™ LCD with MA160011 daughter boards
PIC16F916	16/8	—	256	352	25	28P, 28SO, 28SS, 28ML	ADC/Comp	AUSART, I <sup>2</sup> C/SPI	20	1	4x15 (60)	Yes	Yes	Yes	No	DS163028 PICDEM™ LCD with MA160011 daughter boards
PIC16F917	16/8	—	256	352	36	40P, 44PT, 44ML	ADC/Comp	AUSART, I <sup>2</sup> C/SPI	20	1	4x24 (96)	Yes	Yes	Yes	No	DS163028 PICDEM™ LCD with MA160011 daughter boards
PIC16F946	16/8	—	256	336	53	64PT	ADC/Comp	AUSART, I <sup>2</sup> C/SPI	20	1	4x42 (168)	Yes	Yes	Yes	No	DS163028 PICDEM™ LCD with MA160011 daughter boards
PIC18F6390	8/4	—	—	768	50	64PT	ADC/Comp	EUSART, AUSART, 2xCCP, Mi <sup>2</sup> C/SPI	40	3	4x32 (128)	Yes	Yes	Yes	No	DM163028 PICDEM™ LCD
PIC18F6390*	8/4	✓	—	1024	50	64PT	ADC/Comp	EUSART, AUSART, 2xCCP, Mi <sup>2</sup> C/SPI	40	3	4x33 (132)	Yes	Yes	Yes	Yes	
PIC18F6490	16/8	—	—	768	50	64PT	ADC/Comp	EUSART, AUSART, 2xCCP, Mi <sup>2</sup> C/SPI	40	3	4x32 (128)	Yes	Yes	Yes	No	DM163028 PICDEM™ LCD
PIC18F6493*	16/8	—	—	768	50	64PT	ADC (12-bit)/Comp	EUSART, AUSART, 2xCCP, Mi <sup>2</sup> C/SPI	40	3	4x32 (128)	Yes	Yes	Yes	No	DM163028 PICDEM™ LCD
PIC18F6490*	16/8	✓	—	1024	50	64PT	ADC/Comp	EUSART, AUSART, 2xCCP, Mi <sup>2</sup> C/SPI	40	3	4x33 (132)	Yes	Yes	Yes	Yes	
PIC18F6590*	32/16	✓	—	2048	50	64PT	ADC/Comp	EUSART, AUSART, 2xCCP, Mi <sup>2</sup> C/SPI	40	3	4x33 (132)	Yes	Yes	Yes	Yes	
PIC18F8390	8/4	—	—	768	66	80PT	ADC/Comp	EUSART, AUSART, 2xCCP, Mi <sup>2</sup> C/SPI	40	3	4x48 (192)	Yes	Yes	Yes	No	DM163028 PICDEM™ LCD
PIC18F8390*	8/4	✓	—	1024	66	80PT	ADC/Comp	EUSART, AUSART, 2xCCP, Mi <sup>2</sup> C/SPI	40	3	4x48 (192)	Yes	Yes	Yes	Yes	

\*Contact Microchip Technology Inc. for availability. Refer to LCD Design Center on [www.microchip.com/lcd](http://www.microchip.com/lcd) for further details. Abbreviations are found on the last page of the Selector Guide.

**LCD Solutions (www.microchip.com/lcd) (continued)**

Product	Program Memory (Kbytes/ K words)	Self-Write	Data EEPROM (Bytes)	RAM (Bytes)	I/O Pins	Packages	Analog Peripherals	Digital Peripherals	Max. Speed MHz	ICD # of Breakpoints	LCD Function-Specific Features					Development Boards
											COMxSegment = # Segments	Drive in Sleep	Software Configurable Driver Pins	Direct Drive	Intl. Charge Pump	
PIC18F8490	16/8	—	—	768	66	80PT	ADC/Comp	EUSART, AUSART, 2xCCP, Mi <sup>2</sup> C/SPI	40	3	4x48 (192)	Yes	Yes	No	DM163028 PICDEM™ LCD	
PIC18F8493*	16/8	—	—	768	66	80PT	ADC (12-bit)/ Comp	EUSART, AUSART, 2xCCP, Mi <sup>2</sup> C/SPI	40	3	4x48 (192)	Yes	Yes	No	DM163028 PICDEM™ LCD	
PIC18F84J90*	16/8	✓	—	1024	66	80PT	ADC/Comp	EUSART, AUSART, 2xCCP, Mi <sup>2</sup> C/SPI	40	3	4x48 (192)	Yes	Yes	Yes		
PIC18F85J90*	32/16	✓	—	2048	66	80PT	ADC/Comp	EUSART, AUSART, 2xCCP, Mi <sup>2</sup> C/SPI	40	3	4x48 (192)	Yes	Yes	Yes	DM183022 HPC Explorer Board	

\*Contact Microchip Technology Inc. for availability. Refer to LCD Design Center on www.microchip.com/lcd for further details. Abbreviations are found on the last page of the Selector Guide.

**Display Solutions**

Part #	Display Type	Supply Voltage (V)	Resolution (Digits)	Resolution (Counts)	Power (mW)	Temp. Range (°C)	Features	Packages
TC820	LCD	9	3½	±4,000	10	0 to +70	DMM plus frequency counter and logic probe	40-Pin PDIP, 44-Pin PLCC, 44-Pin MQFP
TC7106	LCD	9	3½	±2,000	10	-25 to +85	For DMM, DPM, Data logger applications	40-Pin PDIP, 44-Pin PLCC, 44-Pin MQFP, 40-Pin CerDIP
TC7106A	LCD	9	3½	±2,000	10	-25 to +85	For DMM, DPM, Data logger applications	40-Pin PDIP, 44-Pin PLCC, 44-Pin MQFP, 40-Pin CerDIP
TC7116	LCD	9	3½	±2,000	10	-25 to +85	Hold function	40-Pin PDIP, 44-Pin PLCC, 44-Pin MQFP, 40-Pin CerDIP
TC7116A	LCD	9	3½	±2,000	10	-25 to +85	Hold function	40-Pin PDIP, 44-Pin PLCC, 44-Pin MQFP, 40-Pin CerDIP
TC7126	LCD	9	3½	±2,000	0.5	-25 to +85	Low-power TC7106	40-Pin PDIP, 44-Pin PLCC, 44-Pin MQFP, 40-Pin CerDIP
TC7126A	LCD	9	3½	±2,000	0.5	-25 to +85	Low-power TC7106	40-Pin PDIP, 44-Pin PLCC, 44-Pin MQFP, 40-Pin CerDIP
TC7129	LCD	9	4½	±20,000	4-5	0 to +70	Lowest noise ±3 mV sensitivity	40-Pin PDIP, 44-Pin PLCC, 44-Pin MQFP

Abbreviations are found on the last page of the Selector Guide.

**Motor Control Solutions - MOSFET Drivers**

Part #	Configuration	Operating Temperature Range (°C)	Peak Output Current (A)	Output Resistance (R <sub>H/RL</sub> ) (Max. $\Omega$ @ 25°C)	Max. Supply Voltage (V)	Input/Output Delay (td1, td2) <sup>(1)</sup> (ns)	Packages
TC1410	Single, Inverting	-40 to +85	0.5	22/22	16	30/30	8-Pin PDIP, 8-Pin SOIC, 8-Pin MSOP
TC1411	Single, Inverting	-40 to +85	1	11/11	16	30/30	8-Pin PDIP, 8-Pin SOIC, 8-Pin MSOP
TC1412	Single, Inverting	-40 to +85	2	6/6	16	35/35	8-Pin PDIP, 8-Pin SOIC, 8-Pin MSOP
TC1413	Single, Inverting	-40 to +85	3	4/4	16	35/35	8-Pin PDIP, 8-Pin SOIC, 8-Pin MSOP
TC4421	Single, Inverting	-40 to +125	9	1.4 (typ)/1.7	18	30/33	8-Pin PDIP, 5-Pin TO-220, 8-Pin DFN
TC4422	Single, Non-inverting	-40 to +125	9	1.4 (typ)/1.7	18	30/33	8-Pin PDIP, 5-Pin TO-220, 8-Pin DFN
TC4423	Dual, Inverting	-40 to +125	3	5/5	18	33/38	8-Pin PDIP, 16-Pin SOIC (W), 8-Pin DFN
TC4425	Dual, Inverting and Non-inverting	-40 to +125	3	5/5	18	33/38	8-Pin PDIP, 16-Pin SOIC (W), 8-Pin DFN

**NOTE 1:** \*td1 = delay time from input low-to-high transition to output transition. td2 = delay time from input high-to-low transition to output transition.

**Motor Control Solutions - LINEAR – Comparators**

Part #	# per Package	V <sub>REF</sub> (V)	Typical Propagation Delay ( $\mu$ s)	I <sub>Q</sub> Typical ( $\mu$ A)	V <sub>OS</sub> Max (mV)	Operating Voltage (V)	Temp. Range (°C)	Features	Packages
TC1027	4	1.2	4	18	5	1.8 to 5.5	-40 to +85	On-board V <sub>REF</sub> , Rail-to-Rail Input/Output	16-Pin PDIP, 16-Pin QSO, 16-Pin SOIC
TC1037	1	—	4	4	5	1.8 to 5.5	-40 to +85	Rail-to-Rail Input/Output	5-Pin SOT-23A (S)
TC1038	1	—	4	4	5	1.8 to 5.5	-40 to +85	Shutdown pin, Rail-to-Rail Input/Output	6-Pin SOT-23A (S)
TC1039	1	1.2	4	6	5	1.8 to 5.5	-40 to +85	On-board V <sub>REF</sub> , Rail-to-Rail Input/Output	6-Pin SOT-23A (S)
TC1041	2	1.2	4	10	5	1.8 to 5.5	-40 to +85	On-board V <sub>REF</sub> , Programmable hysteresis, Rail-to-Rail Input/Output	8-Pin MSOP, 8-Pin SOIC
MCP6541	1	—	4	1	5	1.6 to 5.5	-40 to +85	Push-Pull, Rail-to-Rail Input/Output	5-Pin SOT-23(S,R), 5-Pin SC-70(S), 8-Pin PDIP, 8-Pin SOIC, 8-Pin MSOP
MCP6542	2	—	4	1	5	1.6 to 5.5	-40 to +85	Push-Pull, Rail-to-Rail Input/Output	8-Pin PDIP, 8-Pin SOIC, 8-Pin MSOP
MCP6543	1	—	4	1	5	1.6 to 5.5	-40 to +85	Push-Pull, Rail-to-Rail Input/Output, Chip Select	8-Pin PDIP, 8-Pin SOIC, 8-Pin MSOP
MCP6544	4	—	4	1	5	1.6 to 5.5	-40 to +85	Push-Pull, Rail-to-Rail Input/Output	14-Pin PDIP, 14-Pin SOIC, 14-Pin TSSOP
MCP6546	1	—	4	1	5	1.6 to 5.5	-40 to +85	Open-drain, 9V, Rail-to-Rail Input/Output	5-Pin SOT-23(S,R), 5-Pin SC-70(S), 8-Pin PDIP, 8-Pin SOIC, 8-Pin MSOP
MCP6547	2	—	4	1	5	1.6 to 5.5	-40 to +85	Open-drain, 9V, Rail-to-Rail Input/Output	8-Pin PDIP, 8-Pin SOIC, 8-Pin MSOP
MCP6548	1	—	4	1	5	1.6 to 5.5	-40 to +85	Open-drain, 9V, Rail-to-Rail Input/Output, Chip Select	8-Pin PDIP, 8-Pin SOIC, 8-Pin MSOP
MCP6549	4	—	4	1	5	1.6 to 5.5	-40 to +85	Open-drain, 9V, Rail-to-Rail Input/Output	14-Pin PDIP, 14-Pin SOIC, 14-Pin TSSOP

**Legend:** S = Standard Pinout; R = Reverse Pinout

**Motor Control Solutions - LINEAR – Op Amps**

Part #	# per Package	GBWP	Iq Typical (µA)	Vos Max (mV)	Input Voltage Noise Density (nV/√Hz)	Operating Voltage (V)	Temp. Range (°C)	Features	Packages
TC1034	1	90 kHz	6	1.5	125 <sup>(1)</sup>	1.8 to 5.5	-40 to +85	Rail-to-Rail Input/Output	5-Pin SOT-23A <sup>(R)</sup>
TC1035	1	90 kHz	6	1.5	125 <sup>(1)</sup>	1.8 to 5.5	-40 to +85	Rail-to-Rail Input/Output, Shutdown pin	6-Pin SOT-23A <sup>(R)</sup>
TC1029	2	90 kHz	12	1.5	125 <sup>(1)</sup>	1.8 to 5.5	-40 to +85	Rail-to-Rail Input/Output	8-Pin PDIP, 8-Pin MSOP, 8-Pin SOIC
TC1030	4	90 kHz	5	1.5	125 <sup>(1)</sup>	1.8 to 5.5	-40 to +85	Rail-to-Rail Input/Output, Shutdown pins	16-Pin QSOP
MCP6041	1	14 kHz	0.6	3	170 <sup>(1)</sup>	1.4 to 5.5	-40 to +85	Rail-to-Rail Input/Output	8-Pin PDIP, 8-Pin SOIC, 8-Pin MSOP, 5-Pin SOT-23 <sup>(S)</sup>
MCP6042	2	14 kHz	0.6	3	170 <sup>(1)</sup>	1.4 to 5.5	-40 to +85	Rail-to-Rail Input/Output	8-Pin PDIP, 8-Pin SOIC, 8-Pin MSOP
MCP6043	1	14 kHz	0.6	3	170 <sup>(1)</sup>	1.4 to 5.5	-40 to +85	Rail-to-Rail Input/Output, Chip Select	8-Pin PDIP, 8-Pin SOIC, 8-Pin MSOP
MCP6044	4	14 kHz	0.6	3	170 <sup>(1)</sup>	1.4 to 5.5	-40 to +85	Rail-to-Rail Input/Output	14-Pin PDIP, 14-Pin SOIC, 14-Pin TSSOP
MCP6141	1	100 kHz	0.6	3	170 <sup>(1)</sup>	1.4 to 5.5	-40 to +85	Rail-to-Rail Input/Output, G>10 stable	8-Pin PDIP, 8-Pin SOIC, 8-Pin MSOP
MCP6142	2	100 kHz	0.6	3	170 <sup>(1)</sup>	1.4 to 5.5	-40 to +85	Rail-to-Rail Input/Output, G>10 stable	8-Pin PDIP, 8-Pin SOIC, 8-Pin MSOP
MCP6143	1	100 kHz	0.6	3	170 <sup>(1)</sup>	1.4 to 5.5	-40 to +85	Rail-to-Rail Input/Output, G>10 stable, Chip Select	8-Pin PDIP, 8-Pin SOIC, 8-Pin MSOP
MCP6144	4	100 kHz	0.6	3	170 <sup>(1)</sup>	1.4 to 5.5	-40 to +85	Rail-to-Rail Input/Output, G>10 stable	14-Pin PDIP, 14-Pin SOIC, 14-Pin TSSOP
MCP606	1	155 kHz	19	0.25	38 <sup>(1)</sup>	2.5 to 5.5	-40 to +85	Rail-to-Rail Output	8-Pin PDIP, 8-Pin SOIC, 8-Pin TSSOP, 5-Pin SOT23 <sup>(S)</sup>
MCP607	2	155 kHz	19	0.25	38 <sup>(1)</sup>	2.5 to 5.5	-40 to +85	Rail-to-Rail Output	8-Pin PDIP, 8-Pin SOIC, 8-Pin TSSOP
MCP608	1	155 kHz	19	0.25	38 <sup>(1)</sup>	2.5 to 5.5	-40 to +85	Rail-to-Rail Output, Chip Select	8-Pin PDIP, 8-Pin SOIC, 8-Pin TSSOP
MCP609	4	155 kHz	19	0.25	38 <sup>(1)</sup>	2.5 to 5.5	-40 to +85	Rail-to-Rail Output	14-Pin PDIP, 14-Pin SOIC, 14-Pin TSSOP
MCP616	1	190 kHz	19	0.15	32 <sup>(1)</sup>	2.3 to 5.5	-40 to +85	Rail-to-Rail Output, PNP Input	8-Pin PDIP, 8-Pin SOIC, 8-Pin MSOP
MCP617	2	190 kHz	19	0.15	32 <sup>(1)</sup>	2.3 to 5.5	-40 to +85	Rail-to-Rail Output, PNP	8-Pin PDIP, 8-Pin SOIC, 8-Pin MSOP
MCP618	1	190 kHz	19	0.15	32 <sup>(1)</sup>	2.3 to 5.5	-40 to +85	Rail-to-Rail Output, Chip Select, PNP Input	8-Pin PDIP, 8-Pin SOIC, 8-Pin MSOP
MCP619	4	190 kHz	19	0.15	32 <sup>(1)</sup>	2.3 to 5.5	-40 to +85	Rail-to-Rail Output, PNP Input	14-Pin PDIP, 14-Pin SOIC, 14-Pin TSSOP
MCP6231	1	300 kHz	20	5	52 <sup>(1)</sup>	1.8 to 5.5	-40 to +125	Rail-to-Rail Input/Output	5-Pin SC-70 <sup>(U)</sup> , 5-Pin SOT-23 <sup>(S,R,U)</sup> , 8-Pin PDIP, 8-Pin SOIC, 8-Pin MSOP
MCP6232	2	300 kHz	20	5	52 <sup>(1)</sup>	1.8 to 5.5	-40 to +125	Rail-to-Rail Input/Output	8-Pin PDIP, 8-Pin SOIC, 8-Pin MSOP
MCP6234	4	300 kHz	20	5	52 <sup>(1)</sup>	1.8 to 5.5	-40 to +125	Rail-to-Rail Input/Output	14-Pin PDIP, 14-Pin SOIC, 14-Pin TSSOP
MCP6241	1	550 kHz	50	5	45 <sup>(1)</sup>	1.8 to 5.5	-40 to +125	Rail-to-Rail Input/Output	5-Pin SC-70 <sup>(U)</sup> , 5-Pin SOT-23 <sup>(S,R,U)</sup> , 8-Pin PDIP, 8-Pin SOIC, 8-Pin MSOP
MCP6242	2	550 kHz	50	5	45 <sup>(1)</sup>	1.8 to 5.5	-40 to +125	Rail-to-Rail Input/Output	8-Pin PDIP, 8-Pin SOIC, 8-Pin MSOP
MCP6244	4	550 kHz	50	5	45 <sup>(1)</sup>	1.8 to 5.5	-40 to +125	Rail-to-Rail Input/Output	14-Pin PDIP, 14-Pin SOIC, 14-Pin TSSOP

Legend: S = Standard Pinout; R = Reverse Pinout; U = Alternative Pinout

NOTE 1: Values are typical at 1 kHz

2: Values are typical at 10 kHz

Motor Control Solutions - LINEAR – Op Amps (continued)

Part #	# per Package	GBWP	I <sub>Q</sub> Typical (μA)	V <sub>OS</sub> Max (mV)	Input Voltage Noise Density (nV/√Hz)	Operating Voltage (V)	Temp. Range (°C)	Features	Packages
MCP6001	1	1 MHz	140	4.5	28 <sup>(1)</sup>	1.8 to 5.5	-40 to +125	Rail-to-Rail Input/Output	5-Pin SOT-23(U), 5-Pin SC-70(S,R,U)
MCP6002	2	1 MHz	140	4.5	28 <sup>(1)</sup>	1.8 to 5.5	-40 to +125	Rail-to-Rail Input/Output	8-Pin PDIP, 8-Pin SOIC, 8-Pin MSOP
MCP6004	4	1 MHz	140	4.5	28 <sup>(1)</sup>	1.8 to 5.5	-40 to +125	Rail-to-Rail Input/Output	14-Pin PDIP, 14-Pin SOIC, 14-Pin TSSOP
MCP6271	1	2 MHz	170	3	20 <sup>(1)</sup>	2.0 to 5.5	-40 to +125	Rail-to-Rail Input/Output	5-Pin SOT-23(S,R), 8-Pin PDIP, 8-Pin SOIC, 8-Pin MSOP
MCP6272	2	2 MHz	170	3	20 <sup>(1)</sup>	2.0 to 5.5	-40 to +125	Rail-to-Rail Input/Output	8-Pin PDIP, 8-Pin SOIC, 8-Pin MSOP
MCP6273	1	2 MHz	170	3	20 <sup>(1)</sup>	2.0 to 5.5	-40 to +125	Rail-to-Rail Input/Output, Chip Select	5-Pin SOT-23(S), 8-Pin PDIP, 8-Pin SOIC, 8-Pin MSOP
MCP6274	4	2 MHz	170	3	20 <sup>(1)</sup>	2.0 to 5.5	-40 to +125	Rail-to-Rail Input/Output	14-Pin PDIP, 14-Pin SOIC, 14-Pin TSSOP
MCP6275	2	2 MHz	150	3	20 <sup>(1)</sup>	2.0 to 5.5	-40 to +125	Rail-to-Rail Input/Output, Dual connected, Chip Select	8-Pin PDIP, 8-Pin SOIC, 8-Pin MSOP
MCP601	1	2.8 MHz	230	2	29 <sup>(1)</sup>	2.7 to 5.5	-40 to +125	Rail-to-Rail Output	5-Pin SOT-23(S,R), 8-Pin PDIP, 8-Pin SOIC, 8-Pin TSSOP
MCP602	2	2.8 MHz	230	2	29 <sup>(1)</sup>	2.7 to 5.5	-40 to +125	Rail-to-Rail Output	8-Pin PDIP, 8-Pin SOIC, 8-Pin TSSOP
MCP603	1	2.8 MHz	230	2	29 <sup>(1)</sup>	2.7 to 5.5	-40 to +125	Rail-to-Rail Output, Chip Select	6-Pin SOT-23(S), 8-Pin PDIP, 8-Pin SOIC, 8-Pin TSSOP
MCP604	4	2.8 MHz	230	2	29 <sup>(1)</sup>	2.7 to 5.5	-40 to +125	Rail-to-Rail Output	14-Pin PDIP, 14-Pin SOIC, 14-Pin TSSOP
MCP6281	1	5 MHz	445	3	16 <sup>(1)</sup>	2.2 to 5.5	-40 to +125	Rail-to-Rail Input/Output	5-Pin SOT-23(S,R), 8-Pin PDIP, 8-Pin SOIC, 8-Pin MSOP
MCP6282	2	5 MHz	445	3	16 <sup>(1)</sup>	2.2 to 5.5	-40 to +125	Rail-to-Rail Input/Output	8-Pin PDIP, 8-Pin SOIC, 8-Pin MSOP
MCP6283	1	5 MHz	445	3	16 <sup>(1)</sup>	2.2 to 5.5	-40 to +125	Rail-to-Rail Input/Output, Chip Select	6-Pin SOT-23(S,R), 8-Pin PDIP, 8-Pin SOIC, 8-Pin MSOP
MCP6284	4	5 MHz	445	3	16 <sup>(1)</sup>	2.2 to 5.5	-40 to +125	Rail-to-Rail Input/Output	14-Pin PDIP, 14-Pin SOIC, 14-Pin TSSOP
MCP6285	2	5 MHz	400	3	16 <sup>(1)</sup>	2.2 to 5.5	-40 to +125	Rail-to-Rail Input/Output, Dual connected, Chip Select	8-Pin PDIP, 8-Pin SOIC, 8-Pin MSOP
MCP6291	1	10 MHz	1000	3	8.7 <sup>(2)</sup>	2.4 to 5.5	-40 to +125	Rail-to-Rail Input/Output	5-Pin SOT-23(S,R), 8-Pin PDIP, 8-Pin SOIC, 8-Pin MSOP
MCP6292	2	10 MHz	1000	3	8.7 <sup>(2)</sup>	2.4 to 5.5	-40 to +125	Rail-to-Rail Input/Output	8-Pin PDIP, 8-Pin SOIC, 8-Pin MSOP
MCP6293	1	10 MHz	1000	3	8.7 <sup>(2)</sup>	2.4 to 5.5	-40 to +125	Rail-to-Rail Input/Output, Chip Select	6-Pin SOT-23(S), 8-Pin PDIP, 8-Pin SOIC, 8-Pin MSOP
MCP6294	4	10 MHz	1000	3	8.7 <sup>(2)</sup>	2.4 to 5.5	-40 to +125	Rail-to-Rail Input/Output	14-Pin PDIP, 14-Pin SOIC, 14-Pin TSSOP
MCP6295	2	10 MHz	1100	3	8.7 <sup>(2)</sup>	2.4 to 5.5	-40 to +125	Rail-to-Rail Input/Output, Dual connected, Chip Select	8-Pin PDIP, 8-Pin SOIC, 8-Pin MSOP
MCP6021	1	10 MHz	1000	0.5	8.7 <sup>(2)</sup>	2.5 to 5.5	-40 to +125	Rail-to-Rail Input/Output, 1/2 V <sub>CC</sub> VREF	8-Pin PDIP, 8-Pin SOIC, 8-Pin TSSOP

Legend: S = Standard Pinout; R = Reverse Pinout; U = Alternative Pinout

NOTE 1: Values are typical at 1 kHz

2: Values are typical at 10 kHz



### Motor Control Solutions - LINEAR – Op Amps (continued)

Part #	# per Package	GBWP	I <sub>q</sub> Typical (μA)	V <sub>os</sub> Max (mV)	Input Voltage Noise Density (nV/√Hz)	Operating Voltage (V)	Temp. Range (°C)	Features	Packages
MCP6022	2	10 MHz	1000	0.5	8.7(2)	2.5 to 5.5	-40 to +125	Rail-to-Rail Input/Output	8-Pin PDIP, 8-Pin SOIC, 8-Pin TSSOP
MCP6023	1	10 MHz	1000	0.5	8.7(2)	2.5 to 5.5	-40 to +125	Rail-to-Rail Input/Output, Chip Select	8-Pin PDIP, 8-Pin SOIC, 8-Pin TSSOP
MCP6024	4	10 MHz	1000	0.5	8.7(2)	2.5 to 5.5	-40 to +125	Rail-to-Rail Input/Output	14-Pin PDIP, 14-Pin SOIC, 14-Pin TSSOP

Legend: S = Standard Pinout; R = Reverse Pinout; U = Alternative Pinout

NOTE 1: Values are typical at 1 kHz

2: Values are typical at 10 kHz

### Motor Control Solutions - LINEAR – High Precision Operational Amplifiers

Part #	# per Package	GBWP	I <sub>q</sub> MAX (mA)	Typical V <sub>os</sub> (μV)	V <sub>os</sub> Drift Max (μV/°C)	Operating Voltage (V)	Temp. Range (°C)	Features	Packages
TC913A/B	2	1.5 MHz	1.1	15	0.15/0.30	6.5 to 16	0 to 70	Single and Split Supply	8-Pin PDIP, 8-Pin SOIC

### Intelligent Sensing Solutions

Product	Program Memory (Kbytes)	Self-Write	Data EEPROM (Bytes)	RAM (Bytes)	I/O Pins (max.)	Packages	A/D 12-Bit kspcs	A/D 10-Bit 500 kspcs	Timer 16-Bit	Input Cap	Output Comp/Std PWM	Motor Control PWM	Quad. Encoder	UART	SPI	I <sup>2</sup> C™
dsPIC30F2011	12	✓	—	1024	12	18SO, 18P, 28ML (6x6)	8 ch	—	3	2	2	—	—	1	1	1
dsPIC30F3012	24	✓	1024	2048	12	18SO, 18P, 44ML (8x8)	8 ch	—	3	2	2	—	—	1	1	1
dsPIC30F2012	12	✓	—	1024	20	28SO, 28SP, 28ML (6x6)	10 ch	—	3	2	2	—	—	1	1	1
dsPIC30F3013	24	✓	1024	2048	20	28SO, 28SP, 28ML (6x6)	10 ch	—	3	2	2	—	—	2	1	1
dsPIC33FJ12GP202*	12	✓	—	1024	21	28SO, 28SP, 28ML (6x6), 28SS	10x10-bit @ 1.1 Msps or 12-bit @ 500 kspcs	10x10-bit @ 1.1 Msps or 12-bit @ 500 kspcs	5	4	4	—	—	1	1	1

Abbreviations are found on the last page of the Selector Guide.

**NEW**



<b>Motor Control Solutions</b>			
<b>Minimum Motor Control Feature Set (VDD = 2.0V-5.5V)</b>	<b>6-20 Pin</b>	<b>28-44 Pin</b>	<b>64-100 Pin</b>
Internal Oscillator Selectable Clock (31 kHz-8 MHz)			
Timers/WDT: 1-16 bit, 1-8 bit, 1-WDT			
A/D Channels: 8-bit			
I/O: 12			
Program Memory: 4 Kbytes			
<b>Additional Features to Minimum</b>	<b>6-20 Pin</b>	<b>28-44 Pin</b>	<b>64-80 Pin</b>
Motor Type: Stepper	PIC12F508, PIC16F684, PIC16F716	PIC16F7X7, PIC18F2420 Series	dsPIC30F, dsPIC33FJXXMC
Motor Type: Brushed DC	PIC16F616, PIC16F684, PIC16F716	dsPIC30F, dsPIC33FJXXMC	dsPIC30F, dsPIC33FJXXMC
Motor Type: AC Induction	PIC18F1330	PIC16F7X7, PIC18F2X31, PIC18F4X31, dsPIC30F, dsPIC33FJXXMC	dsPIC30F, dsPIC33FJXXMC
Motor Type: Speed Brushless DC or Permanent Magnet Synchronous Motor (PMSM)	PIC18F1331	PIC18F2X31, PIC18F4X31, dsPIC30F, dsPIC33FJXXMC	dsPIC30F, dsPIC33FJXXMC
Motor Type: Switched Reluctance	PIC18F1332	PIC18F2X31, PIC18F4X31, dsPIC30F, dsPIC33FJXXMC	dsPIC30F, dsPIC33FJXXMC

For additional details, please refer to device data sheets and design pages on [www.microchip.com](http://www.microchip.com).

## CURRENT SECURE DATA PRODUCTS

KEELOQ® Encoder Devices															
Product	Transmission Code Length Bits	Code Hopping Bits	Programmable Encryption Key Bits	Seed Length	Operating Voltage (V)	Turnable OSC	Function Codes	CRC	Protocols	Other Features	Packages				
HCS101	66	—	—	—	3.5 to 13.0	✓	7	No	PWM	Fixed code support for non-secure applications, up to 28-bit serial numbers	8P, 8SN				
HCS200	66	32	64	32	3.5 to 13.0	No	7	No	PWM	Entry level, Fixed code support, Battery-low indicator	8P, 8SN				
HCS201	66	32	64	32	3.5 to 13.0	✓	7	No	PWM	Entry level, Fixed code support, Battery-low indicator, Step-up voltage operation	8P, 8SN				
HCS300	66	32	64	32	2.0 to 6.3	No	15	No	PWM	LED Drive, Overflow bits, Time-out, Battery-low indicator	8P, 8SN				
HCS301	66	32	64	32	3.5 to 13.0	No	15	No	PWM	LED Drive, Overflow bits, Time-out, Battery-low indicator	8P, 8SN				
HCS320	66	32	64	32	3.5 to 13.0	No	16	No	PWM	Shift Operation, LED Drive, Overflow bits, Time-out, Battery-low indicator	8P, 8SN				
HCS360	67	32	64	48	2.0 to 6.3	No	15	✓	IR Mode, PWM and Manchester	2 independent counters	8P, 8SN				
HCS361	67	32	64	48	2.0 to 6.3	No	15	✓	IR Mode, PWM and VPWM	2 independent counters	8P, 8SN				
HCS362	69	32	2 x 64	60	2.0 to 6.3	✓	15	✓	PWM and Manchester	Queue counter, PLL interface, Timer bits, Programmable time-out	8P, 8SN, 8ST				
HCS365	69	32	2 x 64	2 x 60	2.05 to 5.5	Factory	15	✓	PWM, VPWM PPM and Manchester	Dual Encoder Operation, 4 inputs, Queue counter	8P, 8SM				
HCS370	69	32	2 x 64	2 x 60	2.05 to 5.5	Factory	15	✓	PWM, VPWM PPM and Manchester	Step-up voltage regulation, Dual Encoder Operation, 6 inputs, Queue counter	14P, 14SL				
HCS410	69	32	2 x 64	60	2.0 to 6.6	✓	7	✓	PWM and Manchester	Self-powered transponder and encoder, Bidirectional authentication, User EEPROM, Queue counter	8P, 8SN, 8ST				
KEELOQ® Decoder Devices															
Product	Reception Length Bits	Encoders Supported**		Transmitters Supported	Operating Voltage (V)	Functions		Other Features		Packages					
HCS500	66	HCS200, HCS201, HCS300, HCS301, HCS320, HCS360, HCS361, HCS362, HCS365, HCS370, HCS410, HCS412, HCS473	Up to 7	3.0 to 5.5	S0, 15 Serial Functions	Full-featured decoder with serial interface to microcontrollers				8P, 8SM					
HCS512	66	HCS200, HCS201, HCS300, HCS301, HCS320, HCS360, HCS361, HCS362, HCS365, HCS370, HCS410, HCS412, HCS473	Up to 4	4.0 to 6.0	S0, S1, S2, S3; V.Low, 15 Serial Functions	Single chip decoder with secure learning				18P, 18SO					
HCS515	66	HCS200, HCS201, HCS300, HCS301, HCS320, HCS360, HCS361, HCS362, HCS365, HCS370, HCS410, HCS412, HCS473	Up to 7	4.5 to 5.5	S0, S1, 15 Serial Functions	Full-featured decoder with serial and parallel interface. On-chip 1K transmitter and 1K user EEPROM.				14P, 14SL					
KEELOQ® Programmable Encoder/Decoder Flash Devices (x14), ICSP™															
Product	Program Memory (Kbytes/ K words)	Data EEPROM (Bytes)	RAM (Bytes)	I/O Pins	Analog		Digital		Max. Speed MHz	IntOSC	BOR/ PBOR/ PLVD	ICD # of Breakpoints	nW	Other Features	Packages
					ADC Channels	Comparators	Timers/WDT	Serial I/O							
PIC12F635	2/1	128	64	6	—	1	1-16 bit, 1-8 bit, 1-WDT	—	20	8 MHz 32 kHz	BOR/ PLVD	1**	✓		8P, 8SN, 8MD
PIC16F636	4/2	256	128	12	—	2	1-16 bit, 1-8 bit, 1-WDT	—	20	8 MHz 32 kHz	BOR/ PLVD	1**	✓		14P, 14SL, 14ST, 16ML
PIC16F639	4/2	256	128	12	—	2	1-16 bit, 1-8 bit, 1-WDT	—	20	8 MHz 32 kHz	BOR/ PLVD	1**	✓	Transponder Analog Front End	20SS

\*\* Requires ICD specific device with header module – refer to Development Tools. Abbreviations are found on the last page of the Selector Guide.

# CURRENT SERIAL ELECTRICALLY ERASABLE PROMS (EEPROM)

Product	E/W Cycles	Density (Organization)	Write Speed	Max. Clock Freq.	Operating Voltage (V)	Temps	Max. Standby Current	Unique Features	Packages <sup>(1)</sup>
<b>Microwire Compatible Serial EEPROM Family – Automatic ERAL before WRAL, self-timed erase and write cycle, power-on/off data protection circuitry, sequential read function and industry standard 3-wire serial I/O</b>									
93C46A	1M	1 Kbit (x8)	2 ms	2 MHz	4.5 to 5.5	C, I, E	5 µA	93Cx6A and 93Cx6B devices have no ORG pin. 93Cx6A parts have x8 organization; 93Cx6B parts are x16. Devices in this family include POR (VDD detect) feature.	P, SN, ST, MS, OT, X/ SN, MC
93C46B	1M	1 Kbit (x16)	2 ms	2 MHz	4.5 to 5.5	C, I, E	5 µA		P, SN, ST, MS, OT, X/ SN, MC
93C56A	1M	2 Kbits (x8)	2 ms	2 MHz	4.5 to 5.5	I, E	5 µA		P, SN, ST, MS, OT, MC
93C56B	1M	2 Kbits (x16)	2 ms	2 MHz	4.5 to 5.5	I, E	5 µA		P, SN, ST, MS, OT, MC
93C66A	1M	4 Kbits (x8)	2 ms	2 MHz	4.5 to 5.5	I, E	5 µA		P, SN, ST, MS, OT, MC
93C66B	1M	4 Kbits (x16)	2 ms	2 MHz	4.5 to 5.5	I, E	5 µA		P, SN, ST, MS, OT, MC
93C76A	1M	8 Kbits (x8)	2 ms	3 MHz	4.5 to 5.5	I, E	5 µA	Use 93C76C or 93C86C devices for P, SN, ST or MS packages.	OT
93C76B	1M	8 Kbits (x16)	2 ms	3 MHz	4.5 to 5.5	I, E	5 µA	Use 93C76C or 93C86C devices for P, SN, ST or MS packages.	OT
93C86A	1M	16 Kbits (x8)	2 ms	3 MHz	4.5 to 5.5	I, E	5 µA	Use 93C76C or 93C86C devices for P, SN, ST or MS packages.	OT
93C86B	1M	16 Kbits (x16)	2 ms	3 MHz	4.5 to 5.5	I, E	5 µA	Use 93C76C or 93C86C devices for P, SN, ST or MS packages.	OT
93LC46A	1M	1 Kbit (x8)	6 ms	2 MHz	2.5 to 5.5	C, I, E	5 µA	93LCx6A and 93LCx6B devices have no ORG pin. 93LCx6A parts have x8 organization; 93LCx6B parts are x16.	P, SN, ST, MS, OT, X/ SN, MC
93LC46B	1M	1 Kbit (x16)	6 ms	2 MHz	2.5 to 5.5	C, I, E	5 µA		P, SN, ST, MS, OT, X/ SN, MC
93LC56A	1M	2 Kbits (x8)	6 ms	2 MHz	2.5 to 5.5	C, I, E	5 µA		P, SN, ST, MS, OT, X/ SN, MC
93LC56B	1M	2 Kbits (x16)	6 ms	2 MHz	2.5 to 5.5	C, I, E	5 µA		P, SN, ST, MS, OT, X/ SN, MC
93LC66A	1M	4 Kbits (x8)	6 ms	2 MHz	2.5 to 5.5	C, I, E	5 µA		P, SN, ST, MS, OT, X/ SN, MC
93LC66B	1M	4 Kbits (x16)	6 ms	2 MHz	2.5 to 5.5	C, I, E	5 µA		P, SN, ST, MS, OT, X/ SN, MC
93LC76A	1M	8 Kbits (x8)	6 ms	3 MHz	2.5 to 5.5	I, E	5 µA	Use 93LC76C or 93LC86C devices for P, SN, ST or MS packages.	OT
93LC76B	1M	8 Kbits (x16)	6 ms	3 MHz	2.5 to 5.5	I, E	5 µA	Use 93LC76C or 93LC86C devices for P, SN, ST or MS packages.	OT
93LC86A	1M	16 Kbits (x8)	6 ms	3 MHz	2.5 to 5.5	I, E	5 µA	Use 93LC76C or 93LC86C devices for P, SN, ST or MS packages.	OT
93LC86B	1M	16 Kbits (x16)	6 ms	3 MHz	2.5 to 5.5	I, E	5 µA	Use 93LC76C or 93LC86C devices for P, SN, ST or MS packages.	OT
93AA46A	1M	1 Kbit (x8)	6 ms	2 MHz	1.8 to 5.5	I	5 µA	93AAx6A and 93AAx6B devices have no ORG pin. 93AAx6A parts have x8 organization; 93AAx6B parts are x16.	P, SN, ST, MS, OT, MC
93AA46B	1M	1 Kbit (x16)	6 ms	2 MHz	1.8 to 5.5	I	5 µA		P, SN, ST, MS, OT, MC
93AA56A	1M	2 Kbits (x8)	6 ms	2 MHz	1.8 to 5.5	I	5 µA		P, SN, ST, MS, OT, MC
93AA56B	1M	2 Kbits (x16)	6 ms	2 MHz	1.8 to 5.5	I	5 µA		P, SN, ST, MS, OT, MC
93AA66A	1M	4 Kbits (x8)	6 ms	2 MHz	1.8 to 5.5	I	5 µA		P, SN, ST, MS, OT, MC
93AA66B	1M	4 Kbits (x16)	6 ms	2 MHz	1.8 to 5.5	I	5 µA		P, SN, ST, MS, OT, MC
93AA76A	1M	8 Kbits (x8)	6 ms	3 MHz	1.8 to 5.5	I	5 µA	Use 93AA76C or 93AA86C devices for P, SN, ST or MS packages.	OT
93AA76B	1M	8 Kbits (x16)	6 ms	3 MHz	1.8 to 5.5	I	5 µA	Use 93AA76C or 93AA86C devices for P, SN, ST or MS packages.	OT
93AA86A	1M	16 Kbits (x8)	6 ms	3 MHz	1.8 to 5.5	I	5 µA	Use 93AA76C or 93AA86C devices for P, SN, ST or MS packages.	OT
93AA86B	1M	16 Kbits (x16)	6 ms	3 MHz	1.8 to 5.5	I	5 µA	Use 93AA76C or 93AA86C devices for P, SN, ST or MS packages.	OT
93C46C	1M	1 Kbit (x8 or x16)	2 ms	3 MHz	4.5 to 5.5	I, E	5 µA	93Cx6C devices can be used in either x8 or x16 organization via the ORG pin. Devices in this family include POR (VDD detect) feature.	P, SN, ST, MS, MC
93C56C	1M	2 Kbits (x8 or x16)	2 ms	3 MHz	4.5 to 5.5	I, E	5 µA		P, SN, ST, MS, MC
93C66C	1M	4 Kbits (x8 or x16)	2 ms	3 MHz	4.5 to 5.5	I, E	5 µA		P, SN, ST, MS, MC
93C76C	1M	8 Kbits (x8 or x16)	2 ms	3 MHz	4.5 to 5.5	I, E	5 µA		P, SN, ST, MS, MC
93C86C	1M	16 Kbits (x8 or x16)	2 ms	3 MHz	4.5 to 5.5	I, E	5 µA		P, SN, ST, MS, MC
93LC46C	1M	1 Kbit (x8 or x16)	6 ms	3 MHz	2.5 to 5.5	I, E	5 µA	93LCx6C devices can be used in either x8 or x16 organization via the ORG pin.	P, SN, ST, MS, X/ SN, MC
93LC56C	1M	2 Kbits (x8 or x16)	6 ms	3 MHz	2.5 to 5.5	I, E	5 µA		P, SN, ST, MS, X/ SN, MC
93LC66C	1M	4 Kbits (x8 or x16)	6 ms	3 MHz	2.5 to 5.5	I, E	5 µA		P, SN, ST, MS, X/ SN, MC
93LC76C	1M	8 Kbits (x8 or x16)	6 ms	3 MHz	2.5 to 5.5	I, E	5 µA		P, SN, ST, MS, X/ SN, MC
93LC86C	1M	16 Kbits (x8 or x16)	6 ms	3 MHz	2.5 to 5.5	I, E	5 µA		P, SN, ST, MS, X/ SN, MC
93AA46C	1M	1 Kbit (x8 or x16)	6 ms	3 MHz	1.8 to 5.5	I	5 µA	93AAx6C devices can be used in either x8 or x16 organization via the ORG pin.	P, SN, ST, MS, X/ SN, MC
93AA56C	1M	2 Kbits (x8 or x16)	6 ms	3 MHz	1.8 to 5.5	I	5 µA		P, SN, ST, MS, X/ SN, MC
93AA66C	1M	4 Kbits (x8 or x16)	6 ms	3 MHz	1.8 to 5.5	I	5 µA		P, SN, ST, MS, X/ SN, MC
93AA76C	1M	8 Kbits (x8 or x16)	6 ms	3 MHz	1.8 to 5.5	I	5 µA		P, SN, ST, MS, X/ SN, MC
93AA86C	1M	16 Kbits (x8 or x16)	6 ms	3 MHz	1.8 to 5.5	I	5 µA		P, SN, ST, MS, X/ SN, MC

NOTE 1. X/ SN package code denotes rotated pinouts.

Product	E/W Cycles	Density (Organization)	Write Speed	Max. Clock Frequency	Operating Voltage (V)	Temps	Unique Features	Packages
<b>2-Wire I<sup>2</sup>C™ Compatible Serial EEPROM Family – Self-timed write cycle and Page Write mode</b>								
24C00	1M	128 bits (x8)	4 ms	400 kHz	4.5 to 5.5	C, I, E	100 kHz operation for voltages from 1.8V to 4.5V.	P, SN, ST, OT, MC
24LC00	1M	128 bits (x8)	4 ms	400 kHz	2.5 to 6.0	C, I		P, SN, ST, OT, MC
24AA00	1M	128 bits (x8)	4 ms	400 kHz	1.8 to 6.0	C, I		P, SN, ST, OT, MC
24C01C	1M	1 Kbit (x8)	1 ms	400 kHz	4.5 to 5.5	C, I, E	The 24C01C and 24C02C are for applications which require fast byte write and/or extended temperature. Three address pins.	P, SN, ST, MS, MC
24C02C	1M	2 Kbits (x8)	1 ms	400 kHz	4.5 to 5.5	C, I, E		P, SN, ST, MS, MC
24LC014	1M	1 Kbit (x8)	10 ms	400 MHz	2.5 to 5.5	I	Three address pins.	P, SN, ST, MS, MC
24AA014	1M	1 Kbit (x8)	10 ms	400 MHz	1.8 to 5.5	I		P, SN, ST, MS, MC
24LC01B	1M	1 Kbit (x8)	5 ms	400 kHz	2.5 to 5.5	I, E	Hardware write protect. Schmitt trigger inputs.	P, SN, ST, MS, OT, MC
24LC02B	1M	2 Kbits (x8)	5 ms	400 kHz	2.5 to 5.5	I, E	2.5V operation @ extended temperatures.	P, SN, ST, MS, OT, MC
24LC04B	1M	4 Kbits (x8)	5 ms	400 kHz	2.5 to 5.5	I, E	100 kHz operation @ extended temperatures.	P, SN, ST, MS, OT, MC
24LC08B	1M	8 Kbits (x8)	5 ms	400 kHz	2.5 to 5.5	I, E		P, SN, ST, MS, OT, MC
24LC16B	1M	16 Kbits (x8)	5 ms	400 kHz	2.5 to 5.5	I, E	B version on 2-wire devices designates that address pins A0, A1, A2 are no-connect.	P, SN, ST, MS, OT, MC
24AA01	1M	1 Kbit (x8)	5 ms	400 kHz	1.8 to 5.5	I	Hardware write protect. Schmitt trigger inputs.	P, SN, ST, MS, OT, MC
24AA02	1M	2 Kbits (x8)	5 ms	400 kHz	1.8 to 5.5	I	100 kHz operation for voltages from 1.8V to 2.5V	P, SN, ST, MS, OT, MC
24AA04	1M	4 Kbits (x8)	5 ms	400 kHz	1.8 to 5.5	I	For all devices in this section (24AA01 through 24AA16), pins A0, A1, A2 are no-connect.	P, SN, ST, MS, OT, MC
24AA08	1M	8 Kbits (x8)	5 ms	400 kHz	1.8 to 5.5	I		P, SN, ST, MS, OT, MC
24AA16	1M	16 Kbits (x8)	5 ms	400 kHz	1.8 to 5.5	I		P, SN, ST, MS, OT, MC
24LC32A	1M	32 Kbits (x8)	5 ms	400 kHz	2.5 to 5.5	I, E	100 kHz operation for voltages from 1.8V to 2.5V.	P, SN, SM, ST, MS, MC
24AA32A	1M	32 Kbits (x8)	5 ms	400 kHz	1.8 to 5.5	I		P, SN, SM, ST, MS, MC
24LC64	1M	64 Kbits (x8)	5 ms	400 kHz	2.5 to 5.5	I, E	32-byte page. 100 kHz operation for voltages from 1.8V to 2.5V.	P, SN, SM, ST, MS, MC
24AA64	1M	64 Kbits (x8)	5 ms	400 kHz	1.8 to 5.5	I		P, SN, SM, ST, MS, MC
24LC65	1 M/10 M	64 Kbits (x8)	5 ms	400 kHz	2.5 to 5.5	C, I	8-byte page. 64-byte input buffer. high-endurance block, write protectable in 4K blocks. Smart Serial™ EEPROM.	P, SM
24AA65	1 M/10 M	64 Kbits (x8)	5 ms	400 kHz	1.8 to 5.5	C		P, SM
24C65	1 M/10 M	64 Kbits (x8)	5 ms	400 kHz	4.5 to 5.5	C, I, E		P, SM
24LC128	1M	128 Kbits (x8)	5 ms	400 kHz	2.5 to 5.5	I, E	64-byte page. 100 kHz operation for voltages from 1.8V to 2.5V.	P, SN, SM, ST, MS, MF
24AA128	1M	128 Kbits (x8)	5 ms	400 kHz	1.8 to 5.5	I	400 kHz operation for voltages below 4.5V (24FC128).	P, SN, SM, ST, MS, MF
24FC128	1M	128 Kbits (x8)	5 ms	1 MHz	2.5 to 5.5	I		P, SN, SM, ST, MS, MF
24LC256	1M	256 Kbits (x8)	5 ms	400 kHz	2.5 to 5.5	I, E	64-byte page. 100 kHz operation for voltages from 1.8V to 2.5V.	P, SM, SN, ST, MS, MF
24AA256	1M	256 Kbits (x8)	5 ms	400 kHz	1.8 to 5.5	I		P, SM, SN, ST, MS, MF
24FC256	1M	256 Kbits (x8)	5 ms	1 MHz	2.5 to 5.5	I	400 kHz operation for voltages below 4.5V (24FC256).	P, SN, SM, ST, MS, MF
24LC512	1M	512 Kbits (x8)	5 ms	400 kHz	2.5 to 5.5	I, E	128-byte page, cascadeable up to 8 devices (4 Mbits).	P, MF, ST14, SM
24AA512	1M	512 Kbits (x8)	5 ms	400 kHz	1.8 to 5.5	I	100 kHz operation for voltages from 1.8 to 2.5V.	P, MF, ST14, SM
24FC512	1M	512 Kbits (x8)	5 ms	1 MHz	2.5 to 5.5	I	400 kHz operation for voltages below 4.5V (24FC512).	P, MF, ST14, SM
24LC515	1M	512 Kbits (x8)	5 ms	400 kHz	2.5 to 5.5	I	Cascadeable up to 4 devices (2 Mbits).	P, SM
24AA515	1M	512 Kbits (x8)	5 ms	400 kHz	1.8 to 5.5	I	100 kHz operation for voltages from 1.8V to 2.5V.	P, SM
24FC515	1M	512 Kbits (x8)	5 ms	1 MHz	2.5 to 5.5	I		P, SM
24LC1025	1M	1 Mbit (x8)	5 ms	400 kHz	2.5 to 5.5	I, E	Cascade up to 4 devices	P, SM
24AA1025	1M	1 Mbit (x8)	5 ms	400 kHz	1.8 to 5.5	I	Cascade up to 4 devices, 100 kHz @ 1.8V-2.5V	P, SM

Product	EW Cycles	Density (Organization)	Write Speed	Max. Clock Frequency	Operating Voltage (V)	Temps	Unique Features	Packages
<b>ISO Smart Card Family – Self-timed write cycle and Page Write mode. All devices meet ISO7816 pinout requirements.</b>								
24LC01SC	1M	1 Kbit (x8)	5 ms	400 kHz	2.5 to 5.5	C, I		S, W, WF
24LC02SC	1M	2 Kbits (x8)	5 ms	400 kHz	2.5 to 5.5	C, I		S, W, WF
24LC04SC	1M	4 Kbits (x8)	5 ms	400 kHz	2.5 to 5.5	C, I		S, W, WF
24LC08SC	1M	8 Kbits (x8)	5 ms	400 kHz	2.5 to 5.5	C, I		S, W, WF
24LC16SC	1M	16 Kbits (x8)	5 ms	400 kHz	2.5 to 5.5	C, I		S, W, WF
24LC32ASC	1M	32 Kbits (x8)	5 ms	400 kHz	2.5 to 5.5	C, I		S, W, WF
24LC64SC	1M	64 Kbits (x8)	5 ms	400 kHz	2.5 to 5.5	C, I		S, W, WF
24LC128SC	1M	128 Kbits (x8)	5 ms	400 kHz	2.5 to 5.5	C, I		S, W, WF
24LC256SC	1M	256 Kbits (x8)	5 ms	400 kHz	2.5 to 5.5	C, I		S, W, WF
24LC512SC	1M	512 Kbits (x8)	5 ms	400 kHz	2.5 to 5.5	C, I		S, W, WF
24AA01SC	1M	1 Kbit (x8)	5 ms	400 kHz	1.8 to 5.5	C		S, W, WF
24AA02SC	1M	2 Kbits (x8)	5 ms	400 kHz	1.8 to 5.5	C		S, W, WF
24AA04SC	1M	4 Kbits (x8)	5 ms	400 kHz	1.8 to 5.5	C		S, W, WF
24AA08SC	1M	8 Kbits (x8)	5 ms	400 kHz	1.8 to 5.5	C		S, W, WF
24AA16SC	1M	16 Kbits (x8)	5 ms	400 kHz	1.8 to 5.5	C		S, W, WF
24AA32ASC	1M	32 Kbits (x8)	5 ms	400 kHz	1.8 to 5.5	C		S, W, WF
24AA64SC	1M	64 Kbits (x8)	5 ms	400 kHz	1.8 to 5.5	C		S, W, WF
24AA128SC	1M	128 Kbits (x8)	5 ms	400 kHz	1.8 to 5.5	C		S, W, WF
24AA256SC	1M	256 Kbits (x8)	5 ms	400 kHz	1.8 to 5.5	C		S, W, WF
24AA512SC	1M	512 Kbits (x8)	5 ms	400 kHz	1.8 to 5.5	C		S, W, WF

Product	EW Cycles	Density (Organization)	Page Size	Write Speed	Max. Clock Frequency	Operating Voltage (V)	Temps	Unique Features	Packages <sup>(1)</sup>
<b>SPI Compatible Serial EEPROM Family – Page Write mode, HOLD pin, software enabled block write protection and hardware write-protect pin. Supports SPI modes 0, 3.</b>									
25LC010A	1M	1 Kbit (x8)	16B	5 ms	10 MHz	2.5 to 5.5	I, E		P, SN, ST, MS, MC, OT
25AA010A	1M	1 Kbit (x8)	16B	5 ms	10 MHz	1.8 to 5.5	I		P, SN, ST, MS, MC, OT
25LC020A	1M	2 Kbits (x8)	16B	5 ms	10 MHz	2.5 to 5.5	I, E		P, SN, ST, MS, MC, OT
25AA020A	1M	2 Kbits (x8)	16B	5 ms	10 MHz	1.8 to 5.5	I		P, SN, ST, MS, MC, OT
25LC040A	1M	4 Kbits (x8)	16B	5 ms	10 MHz	2.5 to 5.5	I, E		P, SN, ST, MS, MC, OT
25AA040A	1M	4 Kbits (x8)	16B	5 ms	10 MHz	1.8 to 5.5	I		P, SN, ST, MS, MC, OT
25LC080A	1M	8 Kbits (x8)	16B	5 ms	10 MHz	2.5 to 5.5	I, E		P, SN, ST, MS
25AA080A	1M	8 Kbits (x8)	16B	5 ms	10 MHz	1.8 to 5.5	I		P, SN, ST, MS
25LC080B	1M	8 Kbits (x8)	32B	5 ms	10 MHz	2.5 to 5.5	I, E		P, SN, ST, MS
25AA080B	1M	8 Kbits (x8)	32B	5 ms	10 MHz	1.8 to 5.5	I		P, SN, ST, MS

NOTE 1. X1ST package code denotes rotated pinout.

Product	E/W Cycles	Density (Organization)	Page Size	Write Speed	Max. Clock Frequency	Operating Voltage (V)	Temps	Unique Features	Packages <sup>(1)</sup>
<b>SPI Compatible Serial EEPROM Family – Page Write mode, HOLD pin, software enabled block write protection and hardware write-protect pin. Supports SPI modes 0, 3. (continued)</b>									
25LC160A	1M	16 Kbits (x8)	16B	5 ms	10 MHz	2.5 to 5.5	I, E		P, SN, ST, MS
25AA160A	1M	16 Kbits (x8)	16B	5 ms	10 MHz	1.8 to 5.5	I		P, SN, ST, MS
25LC160B	1M	16 Kbits (x8)	32B	5 ms	10 MHz	2.5 to 5.5	I, E		P, SN, ST, MS
25AA160B	1M	16 Kbits (x8)	32B	5 ms	10 MHz	1.8 to 5.5	I		P, SN, ST, MS
25C320	100K	32 Kbits (x8)	32B	5 ms	3 MHz	4.5 to 5.5	I, E		P, SN
25LC320	1M	32 Kbits (x8)	32B	5 ms	2 MHz	2.5 to 5.5	I, E		P, SN, X/ST
25AA320	1M	32 Kbits (x8)	32B	5 ms	1 MHz	1.8 to 5.5	I		P, SN, X/ST
25LC640	1M	64 Kbits (x8)	32B	5 ms	3 MHz	2.5 to 5.5	I, E		P, SN, X/ST
25AA640	1M	64 Kbits (x8)	32B	5 ms	1 MHz	1.8 to 5.5	I		P, SN, X/ST
25LC256	1M	256 Kbits (x8)	64B	5 ms	10 MHz	2.5 to 5.5	I, E		P, SN, ST, MF
25AA256	1M	256 Kbits (x8)	64B	5 ms	10 MHz	1.8 to 5.5	I		P, SN, ST, MF

**NOTE 1. X1ST package code denotes rotated pinout.**

Product	E/W Cycles	Density (Organization)	Write Speed	Max. Clock Frequency	Operating Voltage (V)	Temps	Unique Features	Packages
<b>Identification Products (Application-specific products for monitors, DRAM modules, ACR risers and other plug-and-play applications)</b>								
24LC21A	1M	1 Kbit (x8)	10 ms	400 kHz	2.5 to 5.5	C, I	Completely implements DDC1™/DDC2™ interface for VESA monitor identification. Improved noise filter. Write protection pin plus "return to DDC1" feature.	P, SN
24LCS21A	1M	1 Kbit (x8)	10 ms	400 kHz	2.5 to 5.5	C, I	Same features as 24LC21A plus software enabled write-protect pin.	P, SN
24LCS22A	1M	2 Kbits (x8)	10 ms	400 kHz	2.5 to 5.5	I	Implements VESA E-EDID 1.3 for flat panels and projectors. Includes "return to DDC1" feature and software - enabled write protect pin.	P, SN
24LC024	1M	2 Kbits (x8)	10 ms	400 kHz	2.5 to 5.5	C, I	Addressable, hardware write protection for DRAM DIMM modules and other applications.	P, SN, ST, MS
24LC025	1M	2 Kbits (x8)	10 ms	400 kHz	2.5 to 5.5	C, I	Addressable. No write-protect.	P, SN, ST, MS
24AA52	1M	2 Kbits (x8)	10 ms	400 kHz	1.8 to 5.5	I	Addressable, hardware write protection and software write protection for lower half of the array. Designed for DRAM DIMM modules.	P, SN, ST, MS
24LCS52	1M	2 Kbits (x8)	10 ms	400 kHz	2.5 to 5.5	I		P, SN, ST, MS



## FUTURE SERIAL ELECTRICALLY ERASABLE PROMS (EEPROM)

Part #	E/W Cycles	Density (Organization)	Page Size	Write Speed	Max. Clock Freq.	Operating Voltage (V)	Temps	Unique Features	Packages
<b>SPI Compatible Serial EEPROM Family – Page Write mode, HOLD pin, software enabled block write protection and hardware write-protect pin</b>									
25LC320A	1M	32 Kbits (x8)	32B	5 ms	10 MHz	2.5 to 5.5	I, E		P, SN, ST, MS
25AA320A	1M	32 Kbits (x8)	32B	5 ms	10 MHz	1.8 to 5.5	I, E		P, SN, ST, MS
25LC640A	1M	64 Kbits (x8)	32B	5 ms	10 MHz	2.5 to 5.5	I, E		P, SN, ST, MS
25AA640A	1M	64 Kbits (x8)	32B	5 ms	10 MHz	1.8 to 5.5	I		P, SN, ST, MS
25LC128	1M	128 Kbits (x8)	64B	5 ms	10 MHz	2.5 to 5.5	I, E		P, SN, ST, MS
25AA128	1M	128 Kbits (x8)	64B	5 ms	10 MHz	1.8 to 5.5	I		P, SN, ST, MS
25LC1024	1M	1 Mbit (x8)	256B	5 ms	20 MHz	2.5 to 5.5	I, E		P, SM, MF
25AA1024	1M	1 Mbit (x8)	256B	5 ms	20 MHz	1.8 to 5.5	I		P, SM, MF

## DEVELOPMENT SYSTEMS

### MPLAB® ICE 2000 and MPLAB® ICE 4000 Emulator Systems

#### How Do I Order MPLAB® ICE?

- Ordering MPLAB® ICE is as easy as 1, 2, and 3!
- Choose your PICmicro® MCU.
- Choose your PICmicro® MCU package.
- Find the right line on the next few pages for MPLAB® ICE part numbers. You're ready to order.

#### A Complete MPLAB® ICE System

MPLAB® ICE is a modular emulator system with interchangeable components allowing the system to be easily configured to emulate different PICmicro® MCUs. Since this emulator supports package-specific emulation, customers need to know which device and package they intend to emulate. Then, the customer can use the *Cross Reference Parts List* on the following pages to identify the part numbers required to complete an MPLAB® ICE system. A complete system consists of:

- An emulator pod (including among other things the host-to-pod parallel cable and power supply)
- A processor module
- A device adapter
- A transition socket

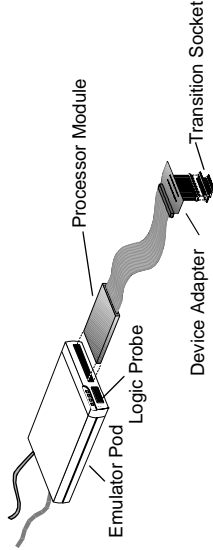

### MPLAB® ICE 2000 Emulator

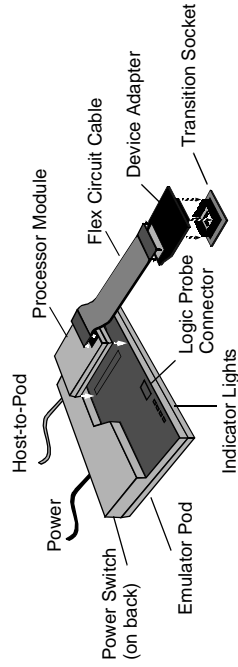

### MPLAB® ICE 4000 Emulator

Components of the MPLAB® ICE emulator system are ordered as separate components. Knowing the terms will make it easy to order and use the MPLAB® ICE emulator system. Read more about each component:

#### Emulator Pod

The MPLAB® ICE 2000 and MPLAB® ICE 4000 are full-featured emulator pods containing a main board with an additional board for expanded trace memory and complex control logic. The MPLAB ICE 2000 pod comes with a standard parallel interface cable that connects the pod to the parallel port of the PC. MPLAB® ICE 4000 also includes a USB interface cable that connects the pod to the USB port. Power supplies are included.

#### Processor Module

The processor module is a PICmicro®, device-specific module that is inserted into the emulator pod. The processor module contains the emulator chip, logic, and low-voltage circuitry. A flex cable extends from the processor module and is connected to the device adapter at the target application.

#### Device Adapter

The device adapter provides a common interface for the PICmicro® MCU being emulated. This adapter contains a special device that provides an oscillator clock allowing the user to accurately emulate the RC characteristics of the PICmicro® MCU. The device adapter provides emulation support for standard DIP and PLCC styles. For emulation support of other packages, a transition socket is needed along with the device adapter.

#### Transition Socket

The transition sockets are available in various styles to allow the common device adapter to be translated to support surface-mount packages, such as SOIC, SSOP, PQFP, TQFP and MLF.

### MPLAB® PM3 Programmers

MPLAB® PM3 Programmer (DV007004) is Microchip's production-rated programmer, which can be operated stand-alone or with a PC using MPLAB® IDE (included free). The programmer comes complete with the necessary accessories to connect to a host system, including a power supply and cables, giving the developer complete control over the programming session. The programmer requires a socket module (sold separately), which can be selected from the chart on the following pages by identifying the devices for programming and then picking the appropriate part number from the respective columns. MPLAB® PM3 has built-in ICSP™ programming capability.

### In-Circuit Debuggers: MPLAB® ICD 2

MPLAB® ICD 2 is a low-cost, flash-based development tool that connects between the PC and the designer's target board allowing direct in-circuit debugging of the PICmicro® target microcontroller. Programs can be executed in real time or single step, watch variables established, break points set, memory read/writes accomplished and more. The MPLAB® ICD 2 can also be used as a development programmer for the microcontrollers.

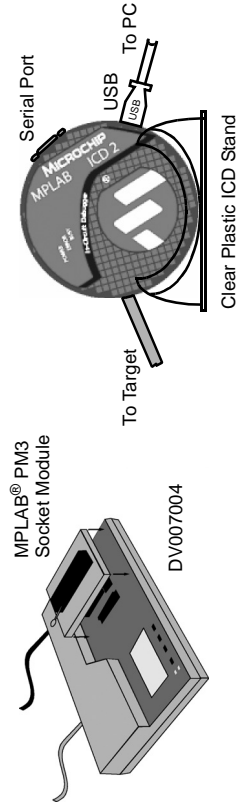

**MPLAB® ICE 2000 and MPLAB® ICE 4000 Emulator Systems, PRO MATE® II Programmer Socket Modules, MPLAB® In-Circuit Debugger, Software Tools, Programmers and Demonstration Boards**

		MPLAB® ICE 2000 System <sup>(1)</sup>				MPLAB® ICE 4000 System <sup>(2)</sup>							
Part Number	Lead Count/ Pkg Type	Processor Module	Device Adapters	Transition Socket	Processor Module	Device Adapters	Transition Socket	PRO MATE® II Socket Module <sup>(3,4)</sup>	MPLAB® PM3 Socket Module <sup>(6)</sup>	PICSTART® Plus <sup>(5)</sup>	MPLAB® ICD 2 <sup>(6)</sup>	MPLAB® CXX Compiler	Demonstration Boards or Evaluation Kits
<b>Analog Interface Development Tools</b>													
MCP2120	14P												DM163008
MCP2150	18P												DM163008
MCP25020	14P								AC164301				DV250501
MCP25020	14SO								AC164302				
MCP25025	14P								AC164301				DV250501
MCP25025	14SO								AC164302				
MCP25050	14P								AC164301				DV250501
MCP25050	14SO								AC164302				
MCP25055	14P								AC164301				DV250501
MCP25055	14SO								AC164302				
MCP2510	18P												DV251001
MCP2515	18P												DV251001
<b>PICmicro® Microcontroller Development Tools</b>													
PIC10F200	60T							AC164037	AC164321	AC163020	AC162059 +XLT06SOT		DV164101 or DV164120 +AC163020
PIC10F200	8P							AC164037	AC164301	✓	AC162059		DV164101, DV164120
PIC10F202	60T							AC164037	AC164321	AC163020	AC162059 +XLT06SOT		DV164101 or DV164120 +AC163020
PIC10F202	8P							AC164037	AC164301	✓	AC162059		DV164101, DV164120
PIC10F204	60T							AC164037	AC164321	AC163020	AC162059 +XLT06SOT		DV164101 or DV164120 +AC163020
PIC10F204	8P							AC164037	AC164301	✓	AC162059		DV164101, DV164120
PIC10F206	60T							AC164037	AC164321	AC163020	AC162059 +XLT06SOT		DV164101 or DV164120 +AC163020
PIC10F206	8P							AC164037	AC164301	✓	AC162059		DV164101, DV164120

NOTE: See complete list of notes on page 108.

## Development Systems Products

### MPLAB® ICE 2000 and MPLAB® ICE 4000 Emulator Systems, PRO MATE® II Programmer Socket Modules, MPLAB® In-Circuit Debugger, Software Tools, Programmers and Demonstration Boards (continued)

Part Number	Lead Count/ Pkg Type	MPLAB® ICE 2000 System <sup>(1)</sup>				MPLAB® ICE 4000 System <sup>(2)</sup>				PICSTART® Plus <sup>(5)</sup>	MPLAB® ICD 2 <sup>(6)</sup>	MPLAB® CXX Compiler	Demonstration Boards or Evaluation Kits
		Processor Module	Device Adapters	Transition Socket	Processor Module	Device Adapters	Transition Socket	PRO MATE® II Socket Module <sup>(3,4)</sup>	MPLAB® PM3 Socket Module <sup>(8)</sup>				
PIC10F220	60T									AC163020*	AC162070** +XLT06SOT		DV164101 or DV164120 +AC163020
PIC10F220	8P									✓	AC162070**		DV164101, DV164120
PIC10F222	60T									AC163020*	AC162070** +XLT06SOT		DV164101* or DV164120 +AC163020
PIC10F222	8P									✓	AC162070**		DV164101* DV164120
PIC12C508	8P, 8JW	PCM16XA0	DVA12XP080							AC164321*	AC162070** +XLT06SOT		DV164101* or DV164120 +AC163020
PIC12C508	8SM	PCM16XA0	DVA12XP080	XLT08SO						AC164301*	AC162070**		DV164101, DV164120
PIC12C508A	8P, 8JW	PCM16XA0	DVA12XP080							AC164301*	AC162070**		DV164101* or DV164120 +AC163020
PIC12C508A	8SM	PCM16XA0	DVA12XP080	XLT08SO						✓	AC162070**		DV164101* DV164120
PIC12C508A	8SN	PCM16XA0	DVA12XP080	XLT08SO						✓	AC162070**		DV164101* DV164120
PIC12C508A	8MF	PCM16XA0	DVA12XP080	XLT08DFN or XLT08DFN2						✓	AC162070**		DV164101* DV164120
PIC12C509	8P, 8JW	PCM16XA0	DVA12XP080							AC164301	AC162070**		DV164101* or DV164120 +AC163020
PIC12C509	8SM	PCM16XA0	DVA12XP080	XLT08SO						AC164312	AC162070**		DV164101, DV164120
PIC12C509A	8P, 8JW	PCM16XA0	DVA12XP080							AC164301	AC162070**		DV164101* or DV164120 +AC163020
PIC12C509A	8SM	PCM16XA0	DVA12XP080	XLT08SO						✓	AC162070**		DV164101* DV164120
PIC12C509A	8SN	PCM16XA0	DVA12XP080	XLT08SO						✓	AC162070**		DV164101* DV164120
PIC12C509A	8MF	PCM16XA0	DVA12XP080	XLT08DFN or XLT08DFN2						✓	AC162070**		DV164101* DV164120
PIC12C671	8P, 8JW	PCM12XA0	DVA12XP081							AC164301	AC162070**		DV164101* or DV164120 +AC163020
PIC12C671	8SM	PCM12XA0	DVA12XP081	XLT08SO						AC164312	AC162070**		DV164101, DV164120
PIC12C671	8MF	PCM12XA0	DVA12XP081	XLT08DFN or XLT08DFN2						AC164324	AC162070**		DV164101* DV164120
PIC12C672	8P, 8JW	PCM12XA0	DVA12XP081							AC164301	AC162070**		DV164101* or DV164120 +AC163020
PIC12C672	8SM	PCM12XA0	DVA12XP081	XLT08SO						AC164312	AC162070**		DV164101, DV164120
PIC12C672	8MF	PCM12XA0	DVA12XP081	XLT08DFN or XLT08DFN2						AC164324	AC162070**		DV164101* DV164120

**NOTE:** See complete list of notes on page 108.

**MPLAB® ICE 2000 and MPLAB® ICE 4000 Emulator Systems, PRO MATE® II Programmer Socket Modules, MPLAB® In-Circuit Debugger, Software Tools, Programmers and Demonstration Boards (continued)**

Part Number	Lead Count/ Pkg Type	MPLAB® ICE 2000 System <sup>(1)</sup>				MPLAB® ICE 4000 System <sup>(2)</sup>				PICSTART® Plus <sup>(5)</sup>	MPLAB® ICD 2 <sup>(6)</sup>	MPLAB® CXX Compiler	Demonstration Boards or Evaluation Kits
		Processor Module	Device Adapters	Transition Socket	Processor Module	Device Adapters	Transition Socket	PROMATE® II Socket Module <sup>(3,4)</sup>	MPLAB® PM3 Socket Module <sup>(6)</sup>				
<b>PICmicro® Microcontroller Development Tools (continued)</b>													
PIC12CE518	8P, 8JW	PCM16XA0	DVA12XP080							✓			
PIC12CE518	8SM	PCM16XA0	DVA12XP080	XLT08SO									
PIC12CE518	8SN	PCM16XA0	DVA12XP080	XLT08SO									
PIC12CE519	8P, 8JW	PCM16XA0	DVA12XP080							✓			
PIC12CE519	8SM	PCM16XA0	DVA12XP080	XLT08SO									
PIC12CE519	8SN	PCM16XA0	DVA12XP080	XLT08SO									
PIC12CE673	8P, 8JW	PCM12XA0	DVA12XP081							✓			
PIC12CE674	8P, 8JW	PCM12XA0	DVA12XP081							✓			
PIC12F508	8P	PCM16XA0	DVA12XP080							✓	AC162059		DV164101, DM163014, DV164120, DM163029
PIC12F508	8SN	PCM16XA0	DVA12XP080	XLT08SO							AC162059 +XLT08SO		
PIC12F508	8ST	PCM16XA0	DVA12XP080										
PIC12F508	8MS	PCM16XA0	DVA12XP080										
PIC12F509	8P	PCM16XA0	DVA12XP080							✓	AC162059		DM163014, DV164101, DV164120, DM163029
PIC12F509	8SN	PCM16XA0	DVA12XP080	XLT08SO							AC162059 +XLT08SO		
PIC12F509	8ST	PCM16XA0	DVA12XP080										
PIC12F509	8MS	PCM16XA0	DVA12XP080										
PIC12F510	8P	PCM16XA0	DVA12XP080							✓	AC162070**		DV164101*, DV164120, DM163029
PIC12F510	8SN	PCM16XA0	DVA12XP080								AC162070** +XLT08SO		
PIC12F510	8MS	PCM16XA0	DVA12XP080								AC162070** +XLT08DFN or XLT08DFN2		
PIC12F510	8MF	PCM16XA0	DVA12XP080										

**NOTE:** See complete list of notes on page 108.

## Development Systems Products

### MPLAB® ICE 2000 and MPLAB® ICE 4000 Emulator Systems, PRO MATE® II Programmer Socket Modules, MPLAB® In-Circuit Debugger, Software Tools, Programmers and Demonstration Boards (continued)

Part Number	MPLAB® ICE 2000 System <sup>(1)</sup>						MPLAB® ICE 4000 System <sup>(2)</sup>						
	Lead Count/ Pkg Type	Processor Module	Device Adapters	Transition Socket	Processor Module	Device Adapters	Transition Socket	PRO MATE® II Socket Module <sup>(3,4)</sup>	MPLAB® PM3 Socket Module <sup>(6)</sup>	PICSTART® Plus <sup>(5)</sup>	MPLAB® ICD 2 <sup>(6)</sup>	MPLAB® CXX Compiler	Demonstration Boards or Evaluation Kits
PIC12F629	8P	PCM12XB0	DVA12XP081				AC124001	AC164301	✓	AC162050			DM163014, DV164101, DV164120, DM163029
PIC12F629	8SN	PCM12XB0	DVA12XP081	XLT08SO			AC164026	AC164302		AC162050 +XLT08SO			
PIC12F629	8MF	PCM12XB0	DVA12XP081	XLT08DFN or XLT08DFN2			AC124001 +AC164032	AC164324	AC164032	AC162050 +XLT08DFN or XLT08DFN2			
PIC12F635	8P	PCM16YM0	DVA1004**	ACICE0201			AC124001	AC164301	✓	AC162057			DM163014, DV164101, DV164120, DM163029
PIC12F635	8SN	PCM16YM0	DVA1004**	XLT08SO			AC164026	AC164302		AC162057 +XLT08SO			
PIC12F635	8MF	PCM16YM0	DVA1004	XLT08DFN or XLT08DFN2			AC124001 +AC164032	AC164324	AC164032	AC162050 +XLT08DFN or XLT08DFN2			
PIC12F675	8P	PCM12XB0	DVA12XP081				AC124001	AC164301	✓	AC162050			DM163014, DV164101, DV164120, DM163029
PIC12F675	8SN	PCM12XB0	DVA12XP081	XLT08SO			AC164026	AC164302		AC162050 +XLT08SO			
PIC12F675	8MF	PCM12XB0	DVA12XP081	XLT08DFN or XLT08DFN2			AC124001 +AC164032	AC164324	AC164032	AC162050 +XLT08DFN or XLT08DFN2			
PIC12F683	8P	PCM12XC0	DVA1004**	ACICE0201			AC124001	AC164301	✓	AC162058			DM163014, DV164101, DV164120, DM163029
PIC12F683	8SN	PCM12XC0	DVA1004**	XLT08SO			AC164026	AC164302		AC162058 +XLT08SO			
PIC12F683	8MF	PCM12XC0	DVA1004	XLT08DFN or XLT08DFN2			AC124001 +AC164032	AC164324	AC164032	AC162058 +XLT08DFN or XLT08DFN2			
PIC14000	28SP, 28JW	PCM14XA0	DVA14XP280				AC144001		✓				
PIC14000	28SO	PCM14XA0	DVA14XP280	XLT28SO			AC144002						
PIC14000	28SS	PCM14XA0	DVA14XP280	XLT28SS			AC144002						
PIC16C52	18P	PCM16XA0	DVA16XP180				AC164001	AC164301	✓				
PIC16C52	18SO	PCM16XA0	DVA16XP180	XLT18SO			AC164002	AC164302	✓				

**NOTE:** See complete list of notes on page 108.

**MPLAB® ICE 2000 and MPLAB® ICE 4000 Emulator Systems, PRO MATE® II Programmer Socket Modules, MPLAB® In-Circuit Debugger, Software Tools, Programmers and Demonstration Boards (continued)**

		MPLAB® ICE 2000 System <sup>(1)</sup>				MPLAB® ICE 4000 System <sup>(2)</sup>							
Part Number	Lead Count/ Pkg Type	Processor Module	Device Adapters	Transition Socket	Processor Module	Device Adapters	Transition Socket	PROMATE® II Socket Module <sup>(3,4)</sup>	MPLAB® PM3 Socket Module <sup>(6)</sup>	PICSTART® Plus <sup>(5)</sup>	MPLAB® ICD 2 <sup>(6)</sup>	MPLAB® CXX Compiler	Demonstration Boards or Evaluation Kits
<b>PICmicro® Microcontroller Development Tools (continued)</b>													
PIC16C54/54A/54C	18P, 18JW	PCM16XA0	DVA16XP180					AC164001	AC164301	✓			
PIC16C54/54A/54C	18SO	PCM16XA0	DVA16XP180	XLT18SO				AC164002	AC164302				
PIC16C54/54A/54C	20SS	PCM16XA0	DVA16XP180	XLT20SS				AC164015	AC164307				
PIC16C55/55A	28P, 28JW	PCM16XA0	DVA16XP280	XLT28XP				AC164001	AC164301	✓			
PIC16C55/55A	28SP	PCM16XA0	DVA16XP280					AC164001	AC164301	✓			
PIC16C55/55A	28SO	PCM16XA0	DVA16XP280	XLT28SO				AC164002	AC164302				
PIC16C55/55A	28SS	PCM16XA0	DVA16XP280	XLT28SS2				AC164015	AC164307				
PIC16C56/56A	18P, 18JW	PCM16XA0	DVA16XP180					AC164001	AC164301	✓			
PIC16C56/56A	18SO	PCM16XA0	DVA16XP180	XLT18SO				AC164002	AC164302				
PIC16C56/56A	20SS	PCM16XA0	DVA16XP180	XLT20SS				AC164015	AC164307				
PIC16C57/57C	28P, 28JW	PCM16XA0	DVA16XP280	XLT28XP				AC164001	AC164301	✓			
PIC16C57/57C	28SP	PCM16XA0	DVA16XP280					AC164001	AC164301	✓			
PIC16C57/57C	28SO	PCM16XA0	DVA16XP280	XLT28SO				AC164002	AC164302				
PIC16C57/57C	28SS	PCM16XA0	DVA16XP280	XLT28SS2				AC164015	AC164307				
PIC16C58A/58B	18P, 18JW	PCM16XA0	DVA16XP180					AC164001	AC164301	✓			
PIC16C58A/58B	18SO	PCM16XA0	DVA16XP180	XLT18SO				AC164002	AC164302				
PIC16C58A/58B	20SS	PCM16XA0	DVA16XP180	XLT20SS				AC164015	AC164307				
PIC16C62A	28P, 28JW	PCM16XB1	DVA16XP282					AC164012	AC164301	✓			DM163022
PIC16C62A	28SO	PCM16XB1	DVA16XP282	XLT28SO				AC164017	AC164302				
PIC16C62A	28SS	PCM16XB1	DVA16XP282	XLT28SS				AC164021	AC164307				
PIC16C62B	28SP, 28JW	PCM16XE1	DVA16XP282					AC164012	AC164301	✓			DM163022
PIC16C62B	28ML	PCM16XE1	DVA16XP282	XLT28QFN4				AC164012 +AC164031	AC164322	AC164031			
PIC16C62B	28SO	PCM16XE1	DVA16XP282	XLT28SO				AC164017	AC164302				
PIC16C62B	28SS	PCM16XE1	DVA16XP282	XLT28SS				AC164021	AC164307				
PIC16C63	28SP, 28JW	PCM16XB1	DVA16XP282					AC164012	AC164301	✓			DM163022, DVMCPA
PIC16C63	28SO	PCM16XB1	DVA16XP282	XLT28SO				AC164017	AC164302				
PIC16C63A	28SP, 28JW	PCM16XE1	DVA16XP282					AC164012	AC164301	✓			DM163022
PIC16C63A	28ML	PCM16XE1	DVA16XP282	XLT28QFN4				AC164012 +AC164031	AC164322	AC164031			
PIC16C63A	28SO	PCM16XE1	DVA16XP282	XLT28SO				AC164017	AC164302				
PIC16C63A	28SS	PCM16XE1	DVA16XP282	XLT28SS				AC164021	AC164307				

**NOTE:** See complete list of notes on page 108.

## Development Systems Products

### MPLAB® ICE 2000 and MPLAB® ICE 4000 Emulator Systems, PRO MATE® II Programmer Socket Modules, MPLAB® In-Circuit Debugger, Software Tools, Programmers and Demonstration Boards (continued)

Part Number	MPLAB® ICE 2000 System <sup>(1)</sup>				MPLAB® ICE 4000 System <sup>(2)</sup>				MPLAB® ICD 2 <sup>(6)</sup>	MPLAB® CXX Compiler	Demonstration Boards or Evaluation Kits
	Lead Count/ Pkg Type	Processor Module	Device Adapters	Transition Socket	Processor Module	Device Adapters	Transition Socket	PRO MATE® II Socket Module <sup>(3,4)</sup>			
<b>PICmicro® Microcontroller Development Tools (continued)</b>											
PIC16C64A	40P, 40JW	PCM16XB1	DVA16XP401				AC164012	AC164301	✓		DM163022
PIC16C64A	44L	PCM16XB1	DVA16XL441	XLT44PT or XLT44PT3			AC164013	AC164309			
PIC16C64A	44PQ	PCM16XB1	DVA16PQ441	XLT44PT or XLT44PT3			AC164014	AC164311			
PIC16C64A	44PT	PCM16XB1	DVA16PQ441	XLT44PT or XLT44PT3			AC164020	AC164305			
PIC16C65A	40P, 40JW	PCM16XB1	DVA16XP401				AC164012	AC164301	✓		DM163022
PIC16C65A	44L	PCM16XB1	DVA16XL441	XLT44PT or XLT44PT3			AC164013	AC164309			
PIC16C65A	44PQ	PCM16XB1	DVA16PQ441	XLT44PT or XLT44PT3			AC164014	AC164311			
PIC16C65A	44PT	PCM16XB1	DVA16PQ441	XLT44PT or XLT44PT3			AC164020	AC164305			
PIC16C65B	40P, 40JW	PCM16XE1	DVA16XP401				AC164012	AC164301	✓		DM163022
PIC16C65B	44L	PCM16XE1	DVA16XL441	XLT44PT or XLT44PT3			AC164013	AC164309			
PIC16C65B	44PQ	PCM16XE1	DVA16PQ441	XLT44PT or XLT44PT3			AC164014	AC164311			
PIC16C65B	44PT	PCM16XE1	DVA16PQ441	XLT44PT or XLT44PT3			AC164020	AC164305			
PIC16C66	28SP, 28JW	PCM16XE1	DVA16XP282	XLT28SO			AC164012	AC164301	✓		DM163022
PIC16C66	28SO	PCM16XE1	DVA16XP282	XLT28SO			AC164017	AC164302			
PIC16C67	40P, 40JW	PCM16XE1	DVA16XP401				AC164012	AC164301	✓		DM163022
PIC16C67	44L	PCM16XE1	DVA16XL441	XLT44PT or XLT44PT3			AC164013	AC164309			
PIC16C67	44PQ	PCM16XE1	DVA16PQ441	XLT44PT or XLT44PT3			AC164014	AC164311			
PIC16C67	44PT	PCM16XE1	DVA16PQ441	XLT44PT or XLT44PT3			AC164020	AC164305			
PIC16C71	18P, 18JW	PCM16XF0	DVA16XP180	XLT18SO			AC164010	AC164301	✓		
PIC16C71	18SO	PCM16XF0	DVA16XP180	XLT18SO			AC164010	AC164302			
PIC16C72	28SP, 28JW	PCM16XB1	DVA16XP282	XLT28SO			AC164012	AC164301	✓		DM163022
PIC16C72	28SO	PCM16XB1	DVA16XP282	XLT28SO			AC164017	AC164302			
PIC16C72	28SS	PCM16XB1	DVA16XP282	XLT28SS			AC164021	AC164307			

**NOTE:** See complete list of notes on page 108.



**MPLAB® ICE 2000 and MPLAB® ICE 4000 Emulator Systems, PRO MATE® II Programmer Socket Modules, MPLAB® In-Circuit Debugger, Software Tools, Programmers and Demonstration Boards (continued)**

Part Number	MPLAB® ICE 2000 System <sup>(1)</sup>				MPLAB® ICE 4000 System <sup>(2)</sup>				PICSTART® Plus <sup>(5)</sup>	MPLAB® ICD 2 <sup>(6)</sup>	MPLAB® CXX Compiler	Demonstration Boards or Evaluation Kits
	Lead Count/ Pkg Type	Processor Module	Device Adapters	Transition Socket	Processor Module	Device Adapters	Transition Socket	PROMATE® II Socket Module <sup>(3,4)</sup>				
<b>PICmicro® Microcontroller Development Tools (continued)</b>												
PIC16C72A	28SP, 28JW	PCM16XE1	DVA 16XP282				AC164012	AC164301	✓			DM163022
PIC16C72A	28ML	PCM16XE1	DVA 16XP282	XLT28QFN4			AC164012 +AC164031	AC164322	AC164031			
PIC16C72A	28SO	PCM16XE1	DVA 16XP282	XLT28SO			AC164017	AC164302				
PIC16C72A	28SS	PCM16XE1	DVA 16XP282	XLT28SS			AC164021	AC164307				
PIC16C73A	28SP, 28JW	PCM16XB1	DVA 16XP282				AC164012	AC164301	✓			DM163022
PIC16C73A	28SO	PCM16XB1	DVA 16XP282	XLT28SO			AC164017	AC164302				
PIC16C73B	28SP, 28JW	PCM16XE1	DVA 16XP282				AC164012	AC164301	✓			DM163022
PIC16C73B	28ML	PCM16XE1	DVA 16XP282	XLT28QFN4			AC164012 +AC164031	AC164322	AC164031			
PIC16C73B	28SO	PCM16XE1	DVA 16XP282	XLT28SO			AC164017	AC164302				
PIC16C73B	28SS	PCM16XE1	DVA 16XP282	XLT28SS			AC164021	AC164307				
PIC16C74A	40P, 40JW	PCM16XB1	DVA 16XP401				AC164012	AC164301	✓			DM163022
PIC16C74A	44L	PCM16XB1	DVA 16XL441				AC164013	AC164309				
PIC16C74A	44PQ	PCM16XB1	DVA 16PQ441	XLT44PT or XLT44PT3			AC164014	AC164311				
PIC16C74A	44PT	PCM16XB1	DVA 16PQ441	XLT44PT or XLT44PT3			AC164020	AC164305				
PIC16C74B	40P, 40JW	PCM16XE1	DVA 16XP401				AC164012	AC164301	✓			DM163022
PIC16C74B	44L	PCM16XE1	DVA 16XL441				AC164013	AC164309				
PIC16C74B	44PQ	PCM16XE1	DVA 16PQ441	XLT44PT or XLT44PT3			AC164014	AC164311				
PIC16C74B	44PT	PCM16XE1	DVA 16PQ441	XLT44PT or XLT44PT3			AC164020	AC164305				
PIC16C76	28SP, 28JW	PCM16XE1	DVA 16XP282				AC164012	AC164301	✓			DM163022
PIC16C76	28SO	PCM16XE1	DVA 16XP282	XLT28SO			AC164017	AC164302				
PIC16C77	40P, 40JW	PCM16XE1	DVA 16XP401				AC164012	AC164301	✓			DM163022
PIC16C77	44L	PCM16XE1	DVA 16XL441				AC164013	AC164309				
PIC16C77	44PQ	PCM16XE1	DVA 16PQ441	XLT44PT or XLT44PT3			AC164014	AC164311				
PIC16C77	44PT	PCM16XE1	DVA 16PQ441	XLT44PT or XLT44PT3			AC164020	AC164305				
PIC16C432	20P, 20JW	PCM16YB0	DVA 16XP201				AC164029	AC164301				DM163005
PIC16C432	20SS	PCM16YB0	DVA 16XP201	XLT20SS1			AC164029	AC164307				DM163007, DM163011

**NOTE:** See complete list of notes on page 108.

## Development Systems Products

### MPLAB® ICE 2000 and MPLAB® ICE 4000 Emulator Systems, PRO MATE® II Programmer Socket Modules, MPLAB® In-Circuit Debugger, Software Tools, Programmers and Demonstration Boards (continued)

Part Number	Lead Count/ Pkg Type	MPLAB® ICE 2000 System <sup>(1)</sup>				MPLAB® ICE 4000 System <sup>(2)</sup>				PICSTART® Plus <sup>(5)</sup>	MPLAB® ICD 2 <sup>(6)</sup>	MPLAB® CXX Compiler	Demonstration Boards or Evaluation Kits
		Processor Module	Device Adapters	Transition Socket	Processor Module	Device Adapters	Transition Socket	PRO MATE® II Socket Module <sup>(3,4)</sup>	MPLAB® PM3 Socket Module <sup>(8)</sup>				
<b>PICmicro® Microcontroller Development Tools (continued)</b>													
PIC16C433	18P, 18JW	PCM16YC0	DVA16XP185	XLT18SO									DM163005
PIC16C433	18SO	PCM16YC0	DVA16XP185	XLT18SO									
PIC16C505	14P, 14JW	PCM16XA0	DVA16XP140	XLT14SO						✓			
PIC16C505	14SL	PCM16XA0	DVA16XP140	XLT14SO									
PIC16C554	18P, 18JW	PCM16XC0	DVA16XP180	XLT18SO						✓			
PIC16C554	18SO	PCM16XC0	DVA16XP180	XLT18SO									
PIC16C554	20SS	PCM16XC0	DVA16XP180	XLT20SS									
PIC16C557	28P												
PIC16C557	28SO												
PIC16C558	18P, 18JW	PCM16XC0	DVA16XP180	XLT18SO						✓			
PIC16C558	18SO	PCM16XC0	DVA16XP180	XLT18SO									
PIC16C558	20SS	PCM16XC0	DVA16XP180	XLT20SS									
PIC16C620/620A	18P, 18JW	PCM16XC0	DVA16XP180	XLT18SO						✓			
PIC16C620/620A	18SO	PCM16XC0	DVA16XP180	XLT18SO									
PIC16C620/620A	20SS	PCM16XC0	DVA16XP180	XLT20SS									
PIC16C621/621A	18P, 18JW	PCM16XC0	DVA16XP180	XLT18SO						✓			
PIC16C621/621A	18SO	PCM16XC0	DVA16XP180	XLT18SO									
PIC16C621/621A	20SS	PCM16XC0	DVA16XP180	XLT20SS									
PIC16C622/622A	18P, 18JW	PCM16XC0	DVA16XP180	XLT18SO						✓			
PIC16C622/622A	18SO	PCM16XC0	DVA16XP180	XLT18SO									
PIC16C622/622A	20SS	PCM16XC0	DVA16XP180	XLT20SS									
PIC16C642	28SP, 28JW	PCM16XD0	DVA16XP282	XLT28SO						✓			DM163022
PIC16C642	28SO	PCM16XD0	DVA16XP282	XLT28SO									

**NOTE:** See complete list of notes on page 108.

**MPLAB® ICE 2000 and MPLAB® ICE 4000 Emulator Systems, PRO MATE® II Programmer Socket Modules, MPLAB® In-Circuit Debugger, Software Tools, Programmers and Demonstration Boards (continued)**

Part Number	Lead Count/ Pkg Type	MPLAB® ICE 2000 System <sup>(1)</sup>				MPLAB® ICE 4000 System <sup>(2)</sup>				PICSTART® Plus <sup>(5)</sup>	MPLAB® ICD 2 <sup>(6)</sup>	MPLAB® CXX Compiler	Demonstration Boards or Evaluation Kits
		Processor Module	Device Adapters	Transition Socket	Processor Module	Device Adapters	Transition Socket	PRO MATE® II Socket Module <sup>(3,4)</sup>	MPLAB® PM3 Socket Module <sup>(6)</sup>				
<b>PICmicro® Microcontroller Development Tools (continued)</b>													
PIC16C662	40P, 40JW	PCM16XD0	DVA 16XP401							✓			DM163022
PIC16C662	44L	PCM16XD0	DVA 16XL441	XLT44PT or XLT44PT3									
PIC16C662	44PQ	PCM16XD0	DVA 16PQ441										
PIC16C662	44PT	PCM16XD0	DVA 16PQ441	XLT44PT or XLT44PT3									
PIC16C710	18P, 18JW	PCM16XF0	DVA 16XP180							✓			
PIC16C710	18SO	PCM16XF0	DVA 16XP180	XLT18SO									
PIC16C710	20SS	PCM16XF0	DVA 16XP180	XLT20SS									
PIC16C711	18P, 18JW	PCM16XF0	DVA 16XP180							✓			
PIC16C711	18SO	PCM16XF0	DVA 16XP180	XLT18SO									
PIC16C711	20SS	PCM16XF0	DVA 16XP180	XLT20SS									
PIC16C712	18P, 18JW	PCM16XE1	DVA 16XP182							✓			
PIC16C712	18SO	PCM16XE1	DVA 16XP182	XLT18SO									
PIC16C712	20SS	PCM16XE1	DVA 16XP182	XLT20SS									
PIC16C715	18P, 18JW	PCM16XG0	DVA 16XP180							✓			
PIC16C715	18SO	PCM16XG0	DVA 16XP180	XLT18SO									
PIC16C715	20SS	PCM16XG0	DVA 16XP180	XLT20SS									
PIC16C716	18P, 18JW	PCM16XE1	DVA 16XP182							✓			
PIC16C716	18SO	PCM16XE1	DVA 16XP182	XLT18SO									
PIC16C716	20SS	PCM16XE1	DVA 16XP182	XLT20SS									
PIC16C717	18P, 18JW	PCM16XN1	DVA 18XP180							✓			
PIC16C717	18SO	PCM16XN1	DVA 18XP180	XLT18SO									
PIC16C717	20SS	PCM16XN1	DVA 18XP180	XLT20SS									
PIC16C745	28SP, 28JW	PCM16XQ1	DVA 16XP282							✓			DM163010
PIC16C745	28SO	PCM16XQ1	DVA 16XP282	XLT28SO									
PIC16C765	40P, 40JW	PCM16XQ1	DVA 16XP401							✓			DM163010
PIC16C765	44L	PCM16XQ1	DVA 16XL441										
PIC16C765	44PT	PCM16XQ1	DVA 16PQ441	XLT44PT or XLT44PT3									

**NOTE:** See complete list of notes on page 108.

## Development Systems Products

### MPLAB® ICE 2000 and MPLAB® ICE 4000 Emulator Systems, PRO MATE® II Programmer Socket Modules, MPLAB® In-Circuit Debugger, Software Tools, Programmers and Demonstration Boards (continued)

Part Number	MPLAB® ICE 2000 System <sup>(1)</sup>				MPLAB® ICE 4000 System <sup>(2)</sup>				PICSTART® Plus <sup>(5)</sup>	MPLAB® ICD 2 <sup>(6)</sup>	MPLAB® CXX Compiler	Demonstration Boards or Evaluation Kits
	Lead Count/ Pkg Type	Processor Module	Device Adapters	Transition Socket	Processor Module	Device Adapters	Transition Socket	PRO MATE® II Socket Module <sup>(3,4)</sup>				
<b>PICmicro® Microcontroller Development Tools (continued)</b>												
PIC16C770	20P, 20JW	PCM16XN1	DVA16XP200	XLT20SO1			AC164028	AC164301	✓			
PIC16C770	20SO	PCM16XN1	DVA16XP200	XLT20SO1			AC164028	AC164302				
PIC16C770	20SS	PCM16XN1	DVA16XP200	XLT20SS1			AC164018	AC164307				
PIC16C771	20P, 20JW	PCM16XN1	DVA16XP200	XLT20SO1			AC164028	AC164301	✓			
PIC16C771	20SO	PCM16XN1	DVA16XP200	XLT20SO1			AC164028	AC164302				
PIC16C771	20SS	PCM16XN1	DVA16XP200	XLT20SS1			AC164018	AC164307				
PIC16C773	28SP, 28JW	PCM16XL0	DVA16XP282	XLT28SO			AC164012	AC164301	✓			DM163022
PIC16C773	28SO	PCM16XL0	DVA16XP282	XLT28SO			AC164017	AC164302				
PIC16C773	28SS	PCM16XL0	DVA16XP282	XLT28SS			AC164021	AC164307				
PIC16C774	40P, 40JW	PCM16XL0	DVA16XP401				AC164012	AC164301	✓			DM163022
PIC16C774	44L	PCM16XL0	DVA16XL441				AC164013	AC164309				
PIC16C774	44PQ	PCM16XL0	DVA16PQ441	XLT44PT or XLT44PT3			AC164014	AC164311				
PIC16C774	44PT	PCM16XL0	DVA16PQ441	XLT44PT or XLT44PT3			AC164020	AC164305				
PIC16C781	20P, 20JW	PCM16XW0	DVA16XP202	XLT20SO1			AC164028	AC164301	✓			DM163012
PIC16C781	20SO	PCM16XW0	DVA16XP202	XLT20SO1			AC164028	AC164302				
PIC16C781	20SS	PCM16XW0	DVA16XP202	XLT20SS1			AC164018	AC164307				
PIC16C782	20P, 20JW	PCM16XW0	DVA16XP202	XLT20SO1			AC164028	AC164301	✓			DM163012
PIC16C782	20SO	PCM16XW0	DVA16XP202	XLT20SO1			AC164028	AC164302				
PIC16C782	20SS	PCM16XW0	DVA16XP202	XLT20SS1			AC164018	AC164307				
PIC16C923	64SP	PCM16XJ0	DVA16XP640	XLT64PT1			AC164025	AC164319				
PIC16C923	64PT	PCM16XJ0	DVA16PQ640	XLT64PT1			AC164023	AC164308	AC164024			
PIC16C923	68L, 68CL	PCM16XJ0	DVA16XL680				AC164022	AC164308				
PIC16C924	64SP	PCM16XJ0	DVA16XP640				AC164025					
PIC16C924	64PT	PCM16XJ0	DVA16PQ640	XLT64PT1			AC164023	AC164319				
PIC16C924	68L, 68CL	PCM16XJ0	DVA16XL680				AC164022	AC164308	AC164024			
PIC16C925	64PT	PCM16XT0	DVA16PQ640	XLT64PT1			AC164023	AC164319				
PIC16C925	68L, 68CL	PCM16XT0	DVA16XL680				AC164022	AC164308	AC164024			
PIC16C926	64PT	PCM16XT0	DVA16PQ640	XLT64PT1			AC164023	AC164319				
PIC16C926	68L, 68CL	PCM16XT0	DVA16XL680				AC164022	AC164308	AC164024			

**NOTE:** See complete list of notes on page 108.

**MPLAB® ICE 2000 and MPLAB® ICE 4000 Emulator Systems, PRO MATE® II Programmer Socket Modules, MPLAB® In-Circuit Debugger, Software Tools, Programmers and Demonstration Boards (continued)**

Part Number	Lead Count/ Pkg Type	MPLAB® ICE 2000 System <sup>(1)</sup>				MPLAB® ICE 4000 System <sup>(2)</sup>				PICSTART® Plus <sup>(5)</sup>	MPLAB® ICD 2 <sup>(6)</sup>	MPLAB® CXX Compiler	Demonstration Boards or Evaluation Kits
		Processor Module	Device Adapters	Transition Socket	Processor Module	Device Adapters	Transition Socket	PRO MATE® II Socket Module <sup>(3,4)</sup>	MPLAB® PM3 Socket Module <sup>(6)</sup>				
<b>PICmicro® Microcontroller Development Tools (continued)</b>													
PIC16CE623	18P, 18JW	PCM16XC0	DVA 16XP180							✓			
PIC16CE623	18SO	PCM16XC0	DVA 16XP180	XLT18SO									
PIC16CE623	20SS	PCM16XC0	DVA 16XP180	XLT20SS									
PIC16CE624	18P, 18JW	PCM16XC0	DVA 16XP180							✓			
PIC16CE624	18SO	PCM16XC0	DVA 16XP180	XLT18SO									
PIC16CE624	20SS	PCM16XC0	DVA 16XP180	XLT20SS									
PIC16CE625	18P, 18JW	PCM16XC0	DVA 16XP180							✓			
PIC16CE625	18SO	PCM16XC0	DVA 16XP180	XLT18SO									
PIC16CE625	20SS	PCM16XC0	DVA 16XP180	XLT20SS									
PIC16F54	18P	PCM16XA0	DVA 16XP180							✓			DV164101, DV164120
PIC16F54	18SO	PCM16XA0	DVA 16XP180	XLT18SO									
PIC16F54	20SS	PCM16XA0	DVA 16XP180	XLT20SS									
PIC16F57	28P	PCM16XA0	DVA 16XP280	XLT28XP									
PIC16F57	28SP	PCM16XA0	DVA 16XP280							✓			DV164101, DV164120
PIC16F57	28SO	PCM16XA0	DVA 16XP280	XLT28SO									
PIC16F57	28SS	PCM16XA0	DVA 16XP280	XLT28SS2									
PIC16F59	40P										✓*		DV164101, DV164120
PIC16F59	44PT										✓*		
PIC16F72	28SP, 28JW	PCM16XS2	DVA 16XP282										DM163022
PIC16F72	28SO	PCM16XS2	DVA 16XP282	XLT28SO						✓			
PIC16F72	28SS	PCM16XS2	DVA 16XP282	XLT28SS									
PIC16F72	28ML	PCM16XS2	DVA 16XP282	XLT28QFN4								AC164031	
PIC16F73	28SP, 28JW	PCM16XS2	DVA 16XP282										
PIC16F73	28ML	PCM16XS2	DVA 16XP282	XLT28QFN4						✓			DM163022
PIC16F73	28SO	PCM16XS2	DVA 16XP282	XLT28SO							✓*		
PIC16F73	28SS	PCM16XS2	DVA 16XP282	XLT28SS							✓*		

**NOTE:** See complete list of notes on page 108.

**MPLAB® ICE 2000 and MPLAB® ICE 4000 Emulator Systems, PRO MATE® II Programmer Socket Modules, MPLAB® In-Circuit Debugger, Software Tools, Programmers and Demonstration Boards (continued)**

		MPLAB® ICE 2000 System <sup>(1)</sup>				MPLAB® ICE 4000 System <sup>(2)</sup>							
Part Number	Lead Count/ Pkg Type	Processor Module	Device Adapters	Transition Socket	Processor Module	Device Adapters	Transition Socket	PRO MATE® II Socket Module <sup>(3,4)</sup>	MPLAB® PM3 Socket Module <sup>(6)</sup>	PICSTART® Plus <sup>(5)</sup>	MPLAB® ICD 2 <sup>(6)</sup>	MPLAB® CXX Compiler	Demonstration Boards or Evaluation Kits
<b>PICmicro® Microcontroller Development Tools (continued)</b>													
PIC16F74	40P	PCM16XS2	DVA16XP401					AC164012	AC164301	✓	✓*		DM163022
PIC16F74	44L	PCM16XS2	DVA16XL441	XLT44PT or XLT44PT3				AC164013	AC164309		✓*		
PIC16F74	44PT	PCM16XS2	DVA16PQ441					AC164020	AC164305		✓*		
PIC16F74	44WL	PCM16XS2	DVA16XL441	XLT44QFN2				AC164012 +AC164034	AC164322	AC164034	✓*		
PIC16F76	28SP, 28JW	PCM16XS2	DVA16XP282					AC164012	AC164301	✓	✓*		DM163022
PIC16F76	28WL	PCM16XS2	DVA16XP282	XLT28QFN4				AC164012 +AC164031	AC164322	AC164031	✓*		
PIC16F76	28SO	PCM16XS2	DVA16XP282	XLT28SO				AC164017	AC164302		✓*		
PIC16F76	28SS	PCM16XS2	DVA16XP282	XLT28SS				AC164021	AC164307		✓*		
PIC16F77	40P, 40JW	PCM16XS2	DVA16XP401					AC164012	AC164301	✓	✓*		DM163022
PIC16F77	44L	PCM16XS2	DVA16XL441					AC164013	AC164309		✓*		
PIC16F77	44WL	PCM16XS2	DVA16XL441	XLT44QFN2				AC164012 +AC164034	AC164322	AC164034	✓*		
PIC16F77	44PT	PCM16XS2	DVA16PQ441	XLT44PT or XLT44PT3				AC164020	AC164305		✓*		
PIC16F83	18P	PCM16XH1	DVA16XP180	XLT18SO				AC164010	AC164301	✓			
PIC16F83	18SO	PCM16XH1	DVA16XP180					AC164010	AC164302				
PIC16F84	18P	PCM16XH1	DVA16XP180	XLT18SO				AC164010	AC164301	✓			
PIC16F84	18SO	PCM16XH1	DVA16XP180					AC164010	AC164302				
PIC16F84A	18P	PCM16XH1	DVA16XP180	XLT18SO				AC164018	AC164307				
PIC16F84A	18SO	PCM16XH1	DVA16XP180					AC164010	AC164302				
PIC16F84A	20SS	PCM16XH1	DVA16XP180	XLT20SS				AC164018	AC164307				
PIC16F87	18P	PCM16YG0	DVA16XP186	XLT18SO				AC164010	AC164301	✓	✓		DM163014
PIC16F87	18SO	PCM16YG0	DVA16XP186					AC164010	AC164302		✓		
PIC16F87	20SS	PCM16YG0	DVA16XP186	XLT20SS				AC164018	AC164307		✓		
PIC16F87	28WL	PCM16YG0	DVA16XP186	XLT28QFN3				AC164010 +AC164033	AC164322	AC164033	✓		
PIC16F88	18P	PCM16YG0	DVA16XP186	XLT18SO				AC164010	AC164301	✓	✓		DM163014
PIC16F88	18SO	PCM16YG0	DVA16XP186					AC164010	AC164302		✓		
PIC16F88	20SS	PCM16YG0	DVA16XP186	XLT20SS				AC164018	AC164307		✓		
PIC16F88	28WL	PCM16YG0	DVA16XP186	XLT28QFN3				AC164010 +AC164033	AC164322	AC164033	✓		

**NOTE:** See complete list of notes on page 108.

**MPLAB® ICE 2000 and MPLAB® ICE 4000 Emulator Systems, PRO MATE® II Programmer Socket Modules, MPLAB® In-Circuit Debugger, Software Tools, Programmers and Demonstration Boards (continued)**

Part Number	Lead Count/ Pkg Type	MPLAB® ICE 2000 System <sup>(1)</sup>			MPLAB® ICE 4000 System <sup>(2)</sup>			PICSTART® Plus <sup>(5)</sup>	MPLAB® ICD 2 <sup>(6)</sup>	MPLAB® CXX Compiler	Demonstration Boards or Evaluation Kits
		Processor Module	Device Adapters	Transition Socket	Processor Module	Device Adapters	Transition Socket				
PIC16F505	14P, 14JW	PCM16XA0	DVA16XP140				✓	AC162059			DM163014, DV164101, DV164120, DM163029
PIC16F505	14SL	PCM16XA0	DVA16XP140	XLT14SO				AC162059 +XLT14SO			
PIC16F505	14ST	PCM16XA0	DVA16XP140								
PIC16F506	14P						✓*	AC162070**			DV164101*, DV164120, DM163029
PIC16F506	14SO							AC162070** +XLT14SO			
PIC16F506	14ST										
PIC16F506	16ML							AC162070** +XLT16QFN1			
PIC16F627	18P, 18JW	PCM16XP0	DVA16XP183				✓				DM163001
PIC16F627	18SO	PCM16XP0	DVA16XP183	XLT18SO							
PIC16F627	20SS	PCM16XP0	DVA16XP183	XLT20SS							
PIC16F627A	18P	PCM16YF0	DVA16XP186				✓	AC162053			
PIC16F627A	18SO	PCM16YF0	DVA16XP186	XLT18SO				AC162053 +XLT18SO			
PIC16F627A	20SS	PCM16YF0	DVA16XP186	XLT20SS				AC162053 +XLT20SS			
PIC16F627A	28ML	PCM16YF0	DVA16XP186	XLT28QFN3				AC162053 +XLT28QFN3			
PIC16F628	18P, 18JW	PCM16XP0	DVA16XP183				✓				
PIC16F628	18SO	PCM16XP0	DVA16XP183	XLT18SO							
PIC16F628	20SS	PCM16XP0	DVA16XP183	XLT20SS							
PIC16F628A	18P	PCM16YF0	DVA16XP186				✓	AC162053			DM163014
PIC16F628A	18SO	PCM16YF0	DVA16XP186	XLT18SO				AC162053 +XLT18SO			
PIC16F628A	20SS	PCM16YF0	DVA16XP186	XLT20SS				AC162053 +XLT20SS			
PIC16F628A	28ML	PCM16YF0	DVA16XP186	XLT28QFN3				AC162053 +XLT28QFN3			

NOTE: See complete list of notes on page 108.

## Development Systems Products

### MPLAB® ICE 2000 and MPLAB® ICE 4000 Emulator Systems, PRO MATE® II Programmer Socket Modules, MPLAB® In-Circuit Debugger, Software Tools, Programmers and Demonstration Boards (continued)

Part Number	Lead Count/ Pkg Type	MPLAB® ICE 2000 System <sup>(1)</sup>				MPLAB® ICE 4000 System <sup>(2)</sup>				PICSTART® Plus <sup>(5)</sup>	MPLAB® ICD 2 <sup>(6)</sup>	MPLAB® CXX Compiler	Demonstration Boards or Evaluation Kits
		Processor Module	Device Adapters	Transition Socket	Transition Socket	Processor Module	Device Adapters	Transition Socket	PRO MATE® II Socket Module <sup>(3,4)</sup>				
PIC16F630	14P	PCM16YD0	DVA16XP141				AC124001	AC164301	✓	AC162052		DM163014, DV164101, DV164120, DM163029	
PIC16F630	14SL	PCM16YD0	DVA16XP141	XLT14SO			AC164026	AC164302		AC162052 +XLT14SO			
PIC16F630	14ST	PCM16YD0	DVA16XP141	XLT14SS			AC164026	AC164306		AC162052 +XLT14SS			
PIC16F636	14P	PCM16YM0	DVA1004**	ACICE0207			AC124001	AC164301	✓	AC162057		DV164120, DM163029	
PIC16F636	14SL	PCM16YM0	DVA1004**	XLT14SO			AC164026	AC164302		AC162057 +XLT14SO			
PIC16F636	14ST	PCM16YM0	DVA1004**	XLT14SS			AC164026	AC164306		AC162057 +XLT14SS			
PIC16F639	20P	PCM16YM0	DVA1004	ACICE0203			AC164039	AC164301	✓	AC162066		DV164101*, DM163014, DM163029	
PIC16F639	20SO	PCM16YM0	DVA1004	XLT20SO1			AC164039	AC164302		AC162066 +XLT20SO1			
PIC16F639	20SS	PCM16YM0	DVA1004	XLT20SS1				AC164307		AC162066 +XLT20SS1			
PIC16F648A	18P	PCM16YF0	DVA16XP186				AC164010	AC164301	✓	AC162053		DM163014	
PIC16F648A	18SO	PCM16YF0	DVA16XP186	XLT18SO			AC164010	AC164302		AC162053 +XLT18SO			
PIC16F648A	20SS	PCM16YF0	DVA16XP186	XLT20SS			AC164018	AC164307		AC162053 +XLT20SS			
PIC16F648A	28ML	PCM16YF0	DVA16XP186	XLT28QFN3			AC164010 +AC164033	AC164322	AC164033	AC162053 +XLT28QFN3			
PIC16F676	14P	PCM16YD0	DVA16XP141				AC124001	AC164301	✓	AC162052		DM163014, DV164101, DV164120, DM163029	
PIC16F676	14SL	PCM16YD0	DVA16XP141	XLT14SO			AC164026	AC164302		AC162052 +XLT14SO			
PIC16F676	14ST	PCM16YD0	DVA16XP141	XLT14SS			AC164026	AC164306		AC162052 +XLT14SS			

NOTE: See complete list of notes on page 108.



**MPLAB® ICE 2000 and MPLAB® ICE 4000 Emulator Systems, PRO MATE® II Programmer Socket Modules, MPLAB® In-Circuit Debugger, Software Tools, Programmers and Demonstration Boards (continued)**

		MPLAB® ICE 2000 System <sup>(1)</sup>			MPLAB® ICE 4000 System <sup>(2)</sup>								
Part Number	Lead Count/ Pkg Type	Processor Module	Device Adapters	Transition Socket	Processor Module	Device Adapters	Transition Socket	PROMATE® II Socket Module <sup>(3,4)</sup>	MPLAB® PM3 Socket Module <sup>(6)</sup>	PICSTART® Plus <sup>(5)</sup>	MPLAB® ICD 2 <sup>(6)</sup>	MPLAB® CXX Compiler	Demonstration Boards or Evaluation Kits
<b>PICmicro® Microcontroller Development Tools (continued)</b>													
PIC16F684	14P	PCM16YK0	DVA1004**	ACICE0207				AC124001	AC164301	✓	AC162055		DV164101, DV164120, DM163029
PIC16F684	14SL	PCM16YK0	DVA1004**	XLT14SO				AC164026	AC164302		AC162055 +XLT14SO		
PIC16F684	14ST	PCM16YK0	DVA1004**	XLT14SS				AC164026	AC164306		AC162055 +XLT14SS		
PIC16F684	16ML	PCM16YK0	DVA1004	XLT16QFN1					AC164324	✓	AC162055 +XLT16QFN1		
PIC16F685	20P	PCM16YQ0	DVA1004	ACICE0203				AC164039	AC164301	✓*	AC162061		DV164120, DM163029
PIC16F685	20SO	PCM16YQ0	DVA1004	XLT20SO1				AC164039	AC164302		AC162061, +XLT20SO1		
PIC16F685	20SS	PCM16YQ0	DVA1004	XLT20SS1					AC164307		AC162061, +XLT20SS1		
PIC16F687	20P	PCM16YQ0	DVA1004	ACICE0203				AC164039	AC164301	✓*	AC162061		DV164120, DM163029
PIC16F687	20SO	PCM16YQ0	DVA1004	XLT20SO1				AC164039	AC164302		AC162061, +XLT20SO1		
PIC16F687	20SS	PCM16YQ0	DVA1004	XLT20SS1					AC164307		AC162061, +XLT20SS1		
PIC16F688	14P	PCM16YL0	DVA1004**	ACICE0207				AC124001	AC164301	✓	AC162056		DV164101, DV164120, DM163029
PIC16F688	14SL	PCM16YL0	DVA1004**	XLT14SO				AC164026	AC164302		AC162056 +XLT14SO		
PIC16F688	14ST	PCM16YL0	DVA1004**	XLT14SS				AC164026	AC164306		AC162056 +XLT14SS		
PIC16F689	20P	PCM16YQ0	DVA1004	ACICE0203				AC164039	AC164301	✓	AC162061		DV164120, DM163029
PIC16F689	20SO	PCM16YQ0	DVA1004	XLT20SO1				AC164039	AC164302		AC162061, +XLT20SO1		
PIC16F689	20SS	PCM16YQ0	DVA1004	XLT20SS1					AC164307		AC162061, +XLT20SS1		

NOTE: See complete list of notes on page 108.

## Development Systems Products

### MPLAB<sup>®</sup> ICE 2000 and MPLAB<sup>®</sup> ICE 4000 Emulator Systems, PRO MATE<sup>®</sup> II Programmer Socket Modules, MPLAB<sup>®</sup> In-Circuit Debugger, Software Tools, Programmers and Demonstration Boards (continued)

Part Number	Lead Count/ Pkg Type	MPLAB <sup>®</sup> ICE 2000 System <sup>(1)</sup>				MPLAB <sup>®</sup> ICE 4000 System <sup>(2)</sup>				MPLAB <sup>®</sup> CXX Compiler	Demonstration Boards or Evaluation Kits
		Processor Module	Device Adapters	Transition Socket	Processor Module	Device Adapters	Transition Socket	PRO MATE <sup>®</sup> II Socket Module <sup>(3,4)</sup>	MPLAB <sup>®</sup> PM3 Socket Module <sup>(6)</sup>		
<b>PICmicro<sup>®</sup> Microcontroller Development Tools (continued)</b>											
PIC16F690	20P	PCM16YQ0	DVA1004	ACICE0203		AC164039	AC164301	✓	AC162061		DV164120, DM163029
PIC16F690	20SO	PCM16YQ0	DVA1004	XLT20SO1		AC164039	AC164302		AC162061, +XLT20SO1		
PIC16F690	20SS	PCM16YQ0	DVA1004	XLT20SS1			AC164307		AC162061, +XLT20SS1		
PIC16F716	18P	PCM16YJ0	DVA1001**			AC164010	AC164301	✓	AC162054		
PIC16F716	18SO	PCM16YJ0	DVA1001**	XLT18SO		AC164010	AC164302		AC162054 +XLT18SO		
PIC16F716	20SS	PCM16YJ0	DVA1001**	XLT20SS		AC164018	AC164307		AC162054 +XLT20SS		
PIC16F737	28SP	PCM16YH0	DVA18XP280			AC164012	AC164301	✓	✓		
PIC16F737	28SO	PCM16YH0	DVA18XP280	XLT28SO		AC164017	AC164302		✓		
PIC16F737	28SS	PCM16YH0	DVA18XP280	XLT28SS		AC164021	AC164307		✓		
PIC16F737	28ML	PCM16YH0	DVA18XP280	XLT28QFN4		AC164012 +AC164031	AC164322	AC164031	✓		
PIC16F747	40P	PCM16YH0	DVA18XP400			AC164012	AC164301	✓	✓		
PIC16F747	44PT	PCM16YH0	DVA18PQ440	XLT44PT of XLT44PT3		AC164020	AC164305		✓		
PIC16F747	44ML	PCM16YH0	DVA18XP400	XLT44QFN2		AC164012 +AC164034	AC164322	AC164034	✓		
PIC16F767	28P	PCM16YH0	DVA18XP280			AC164012	AC164301	✓	✓		
PIC16F767	28SO	PCM16YH0	DVA18XP280	XLT28SO		AC164017	AC164302		✓		
PIC16F767	28SS	PCM16YH0	DVA18XP280	XLT28SS		AC164021	AC164307		✓		
PIC16F767	28ML	PCM16YH0	DVA18XP280	XLT28QFN4		AC164012 +AC164031	AC164322	AC164031	✓		
PIC16F777	40P	PCM16YH0	DVA18XP400			AC164012	AC164301	✓	✓		
PIC16F777	44PT	PCM16YH0	DVA18PQ440	XLT44PT of XLT44PT3		AC164020	AC164305		✓		
PIC16F777	44ML	PCM16YH0	DVA18XP400	XLT44QFN2		AC164012 +AC164034	AC164322	AC164034	✓		
PIC16F785	20P	PCM16YN0	DVA1004	ACICE0203		AC164039	AC164301	✓	AC162060		DV164120, DM163029
PIC16F785	20SO	PCM16YN0	DVA1004	XLT20SO1		AC164039	AC164302		AC162060, +XLT20SO1		
PIC16F785	20SS	PCM16YN0	DVA1004	XLT20SS1			AC164307		AC162060, +XLT20SS1		

NOTE: See complete list of notes on page 108.

**MPLAB® ICE 2000 and MPLAB® ICE 4000 Emulator Systems, PRO MATE® II Programmer Socket Modules, MPLAB® In-Circuit Debugger, Software Tools, Programmers and Demonstration Boards (continued)**

Part Number	Lead Count/ Pkg Type	MPLAB® ICE 2000 System <sup>(1)</sup>				MPLAB® ICE 4000 System <sup>(2)</sup>				PICSTART® Plus <sup>(5)</sup>	MPLAB® ICD 2 <sup>(6)</sup>	MPLAB® CXX Compiler	Demonstration Boards or Evaluation Kits
		Processor Module	Device Adapters	Transition Socket	Processor Module	Device Adapters	Transition Socket	PROMATE® II Socket Module <sup>(3,4)</sup>	MPLAB® PM3 Socket Module <sup>(6)</sup>				
<b>PICmicro® Microcontroller Development Tools (continued)</b>													
PIC16F818	18P	PCM16YE0	DVA 16XP186							✓	✓		DM163014
PIC16F818	18SO	PCM16YE0	DVA 16XP186	XLT18SO						✓	✓		
PIC16F818	20SS	PCM16YE0	DVA 16XP186	XLT20SS						✓	✓		
PIC16F818	28ML	PCM16YE0	DVA 16XP186	XLT28QFN3						AC164033	✓		
PIC16F819	18P	PCM16YE0	DVA 16XP186							✓	✓		DM163014
PIC16F819	18SO	PCM16YE0	DVA 16XP186	XLT18SO						✓	✓		
PIC16F819	20SS	PCM16YE0	DVA 16XP186	XLT20SS						✓	✓		
PIC16F819	28ML	PCM16YE0	DVA 16XP186	XLT28QFN3						AC164033	✓		
PIC16F870	28SP, 28JW	PCM16XR1	DVA 16XP282							✓	✓		DM163022
PIC16F870	28SO	PCM16XR1	DVA 16XP282	XLT28SO						✓	✓		
PIC16F870	28SS	PCM16XR1	DVA 16XP282	XLT28SS						✓	✓		
PIC16F871	40P	PCM16XR1	DVA 16XP401							✓	✓		DM163022
PIC16F871	44L	PCM16XR1	DVA 16XL441							✓	✓		
PIC16F871	44PT	PCM16XR1	DVA 16PQ441	XLT44PT or XLT44PT3						✓	✓		
PIC16F872	28SP	PCM16XK1	DVA 16XP282							✓	✓		DM163022
PIC16F872	28SO	PCM16XK1	DVA 16XP282	XLT28SO						✓	✓		
PIC16F872	28SS	PCM16XK1	DVA 16XP282	XLT28SS						✓	✓		
PIC16F873	28SP	PCM16XK1	DVA 16XP282							✓	✓		DM163022
PIC16F873	28SO	PCM16XK1	DVA 16XP282	XLT28SO						✓	✓		
PIC16F873A	28SP	PCM16XV0	DVA 16XP282							✓	✓		DM163022
PIC16F873A	28SO	PCM16XV0	DVA 16XP282	XLT28SO						✓	✓		
PIC16F873A	28SS	PCM16XV0	DVA 16XP282	XLT28SS						✓	✓		
PIC16F873A	28ML	PCM16XV0	DVA 16XP282	XLT28QFN4						AC164031	✓		
PIC16F874	40P	PCM16XK1	DVA 16XP401							✓	✓		DM163022
PIC16F874	44L	PCM16XK1	DVA 16XL441							✓	✓		
PIC16F874	44PQ	PCM16XK1	DVA 16PQ441	XLT44PT or XLT44PT3						✓	✓		
PIC16F874	44PT	PCM16XK1	DVA 16PQ441	XLT44PT or XLT44PT3						✓	✓		

NOTE: See complete list of notes on page 108.

## Development Systems Products

### MPLAB® ICE 2000 and MPLAB® ICE 4000 Emulator Systems, PRO MATE® II Programmer Socket Modules, MPLAB® In-Circuit Debugger, Software Tools, Programmers and Demonstration Boards (continued)

		MPLAB® ICE 2000 System <sup>(1)</sup>				MPLAB® ICE 4000 System <sup>(2)</sup>							
Part Number	Lead Count/ Pkg Type	Processor Module	Device Adapters	Transition Socket	Processor Module	Device Adapters	Transition Socket	PRO MATE® II Socket Module <sup>(3,4)</sup>	MPLAB® PM3 Socket Module <sup>(8)</sup>	PICSTART® Plus <sup>(5)</sup>	MPLAB® ICD 2 <sup>(6)</sup>	MPLAB® CXX Compiler	Demonstration Boards or Evaluation Kits
<b>PICmicro® Microcontroller Development Tools (continued)</b>													
PIC16F874A	40P	PCM16XV0	DVA16XP401					AC164012	AC164301	✓	✓		DM163022
PIC16F874A	44L	PCM16XV0	DVA16XL441	XLT44PT or XLT44PT3				AC164013	AC164309	✓	✓		
PIC16F874A	44PT	PCM16XV0	DVA16PQ441					AC164020	AC164305	✓	✓		
PIC16F874A	44ML	PCM16XV0	DVA16XP401	XLT44QFN2				AC164012 +AC164034	AC164322	AC164034	✓		
PIC16F876	28SP	PCM16XK1	DVA16XP282					AC164012	AC164301	✓	✓		DM163022
PIC16F876	28SO	PCM16XK1	DVA16XP282	XLT28SO				AC164017	AC164302	✓	✓		
PIC16F876A	28SP	PCM16XV0	DVA16XP282					AC164012	AC164301	✓	✓		DM163022
PIC16F876A	28SO	PCM16XV0	DVA16XP282	XLT28SO				AC164017	AC164302	✓	✓		
PIC16F876A	28SS	PCM16XV0	DVA16XP282	XLT28SS				AC164021	AC164307	✓	✓		
PIC16F876A	28ML	PCM16XV0	DVA16XP282	XLT28QFN4				AC164012 +AC164031	AC164322	AC164031	✓		
PIC16F877	40P	PCM16XK1	DVA16XP401					AC164012	AC164301	✓	✓		DM163022
PIC16F877	44L	PCM16XK1	DVA16XL441					AC164013	AC164309	✓	✓		
PIC16F877	44PQ	PCM16XK1	DVA16PQ441	XLT44PT or XLT44PT3				AC164014	AC164311	✓	✓		
PIC16F877	44PT	PCM16XK1	DVA16PQ441	XLT44PT or XLT44PT3				AC164020	AC164305	✓	✓		
PIC16F877A	40P	PCM16XV0	DVA16XP401					AC164012	AC164301	✓	✓		DM163022
PIC16F877A	44L	PCM16XV0	DVA16XL441					AC164013	AC164309	✓	✓		
PIC16F877A	44PT	PCM16XV0	DVA16PQ441	XLT44PT or XLT44PT3				AC164020	AC164305	✓	✓		
PIC16F877A	44ML	PCM16XV0	DVA16XP401	XLT44QFN2				AC164012 +AC164034	AC164322	AC164034	✓		
PIC16F913	28P	PCM16YPO	DVA18XP280					AC164012	AC164301	✓*	✓		DV164120
PIC16F913	28SO	PCM16YPO	DVA18XP280	XLT28SO				AC164017	AC164302	✓	✓		
PIC16F913	28SS	PCM16YPO	DVA18XP280	XLT28SS				AC164021	AC164307	✓	✓		
PIC16F913	28ML	PCM16YPO	DVA18XP280	XLT28QFN4				AC164012 +AC164031	AC164322	AC164031	✓		

**NOTE:** See complete list of notes on page 108.

**MPLAB® ICE 2000 and MPLAB® ICE 4000 Emulator Systems, PRO MATE® II Programmer Socket Modules, MPLAB® In-Circuit Debugger, Software Tools, Programmers and Demonstration Boards (continued)**

Part Number	Lead Count/ Pkg Type	MPLAB® ICE 2000 System <sup>(1)</sup>				MPLAB® ICE 4000 System <sup>(2)</sup>				PICSTART® Plus <sup>(5)</sup>	MPLAB® ICD 2 <sup>(6)</sup>	MPLAB® CXX Compiler	Demonstration Boards or Evaluation Kits
		Processor Module	Device Adapters	Transition Socket	Processor Module	Device Adapters	Transition Socket	PRO MATE® II Socket Module <sup>(3,4)</sup>	MPLAB® PM3 Socket Module <sup>(6)</sup>				
<b>PICmicro® Microcontroller Development Tools (continued)</b>													
PIC16F914	40P	PCM16YP0	DVA18XP400							✓*	✓		DV164120, DM163029
PIC16F914	44PT	PCM16YP0	DVA18PQ440	XLT44PT or XLT44PT3						✓	✓		
PIC16F914	44ML	PCM16YP0	DVA18XP400	XLT44QFN2						AC164034	✓		
PIC16F916	28P	PCM16YP0	DVA18XP280							✓*	✓		DV164120
PIC16F916	28SO	PCM16YP0	DVA18XP280	XLT28SO						✓	✓		MA160011
PIC16F916	28SS	PCM16YP0	DVA18XP280	XLT28SS						✓	✓		
PIC16F916	28ML	PCM16YP0	DVA18XP280	XLT28QFN4						AC164012 +AC164031	✓		
PIC16F917	40P	PCM16YP0	DVA18XP400							✓*	✓		DV164120, DM163029
PIC16F917	44PT	PCM16YP0	DVA18PQ440	XLT44PT or XLT44PT3						✓	✓		MA160011
PIC16F917	44ML	PCM16YP0	DVA18XP400	XLT44QFN2						AC164012 +AC164034	✓		
PIC16F946	64PT	PCM16YP0	DVA1005	XLT64PT2 or XLT64PT5						AC164319	✓		MA160011
PIC16HV540	18P, 18JW												
PIC16HV540	18SO									AC164001	✓		
PIC16HV540	20SS									AC164002			
PIC17C42A	40P, 40JW	PCM17XA0	DVA17XP401							AC164015			
PIC17C42A	44L	PCM17XA0	DVA17XL441	XLT44PT or XLT44PT3						AC174001	✓		
PIC17C42A	44PQ	PCM17XA0	DVA17PQ441	XLT44PT or XLT44PT3						AC174002			
PIC17C42A	44PT	PCM17XA0	DVA17PQ441	XLT44PT or XLT44PT3						AC174004			
PIC17C43	40P, 40JW	PCM17XA0	DVA17XP401							AC174005			
PIC17C43	44L	PCM17XA0	DVA17XL441	XLT44PT or XLT44PT3						AC164301	✓		
PIC17C43	44PQ	PCM17XA0	DVA17PQ441	XLT44PT or XLT44PT3						AC164317			
PIC17C43	44PT	PCM17XA0	DVA17PQ441	XLT44PT or XLT44PT3						AC164316			

**NOTE:** See complete list of notes on page 108.

## Development Systems Products

### MPLAB® ICE 2000 and MPLAB® ICE 4000 Emulator Systems, PRO MATE® II Programmer Socket Modules, MPLAB® In-Circuit Debugger, Software Tools, Programmers and Demonstration Boards (continued)

		MPLAB® ICE 2000 System <sup>(1)</sup>				MPLAB® ICE 4000 System <sup>(2)</sup>							
Part Number	Lead Count/ Pkg Type	Processor Module	Device Adapters	Transition Socket	Processor Module	Device Adapters	Transition Socket	PRO MATE® II Socket Module <sup>(3,4)</sup>	MPLAB® PM3 Socket Module <sup>(6)</sup>	PICSTART® Plus <sup>(5)</sup>	MPLAB® ICD 2 <sup>(6)</sup>	MPLAB® CXX Compiler	Demonstration Boards or Evaluation Kits
<b>PICmicro® Microcontroller Development Tools (continued)</b>													
PIC17C44	40P, 40JW	PCM17XA0	DVA17XP401					AC174001	AC164301	✓			
PIC17C44	44L	PCM17XA0	DVA17XL441	XLT44PT or XLT44PT3				AC174002	AC164317				
PIC17C44	44PQ	PCM17XA0	DVA17PQ441	XLT44PT or XLT44PT3				AC174004	AC164316				
PIC17C44	44PT	PCM17XA0	DVA17PQ441	XLT44PT or XLT44PT3				AC174005	AC164315				
PIC17C752	68L	PCM17XA0	DVA17XL681	XLT64PT2 or XLT64PT5				AC174007	AC164308	AC164024			DM173001
PIC17C752	64PT	PCM17XA0	DVA17PQ641	XLT64PT2 or XLT64PT5				AC174008	AC164319				
PIC17C756/756A	68L, 68CL	PCM17XA0	DVA17XL681	XLT64PT2 or XLT64PT5				AC174007	AC164308	AC164024			DM173001
PIC17C756/756A	64PT	PCM17XA0	DVA17PQ641	XLT64PT2 or XLT64PT5				AC174008	AC164319				
PIC17C762	84L	PCM17XA0	DVA17XL841	XLT80PT or XLT80PT3				AC174012	AC164318	AC164027			DM173001
PIC17C762	80PT	PCM17XA0	DVA17PQ801	XLT80PT or XLT80PT3				AC174011	AC164320				
PIC17C766	84L, 84CL	PCM17XA0	DVA17XL841	XLT80PT or XLT80PT3				AC174012	AC164318	AC164027			DM173001
PIC17C766	80PT	PCM17XA0	DVA17PQ801	XLT80PT or XLT80PT3				AC174011	AC164320				
PIC18C242	28SP, 28JW	PCM18XA0	DVA16XP282	XLT28SO				AC164012	AC164301	✓		SW006011	DM163022
PIC18C242	28SO	PCM18XA0	DVA16XP282	XLT28SO				AC164017	AC164302			SW006011	
PIC18C252	28SP	PCM18XA0	DVA16XP282	XLT28XP				AC164012	AC164301	✓		SW006011	DM163022
PIC18C252	28JW	PCM18XA0	DVA16XP282	XLT28XP				AC164012	AC164301			SW006011	DM163022
PIC18C252	28SO	PCM18XA0	DVA16XP282	XLT28SO				AC164017	AC164302			SW006011	
PIC18C442	40P, 40JW	PCM18XA0	DVA16XP401					AC164012	AC164301	✓		SW006011	DM163022
PIC18C442	44L	PCM18XA0	DVA16XL441	XLT44PT or XLT44PT3				AC164013	AC164309			SW006011	
PIC18C442	44PT	PCM18XA0	DVA16PQ441	XLT44PT or XLT44PT3				AC164020	AC164305			SW006011	
PIC18C452	40P, 40JW	PCM18XA0	DVA16XP401					AC164012	AC164301	✓		SW006011	DM163022
PIC18C452	44L	PCM18XA0	DVA16XL441					AC164013	AC164309			SW006011	
PIC18C452	44PT	PCM18XA0	DVA16PQ441	XLT44PT or XLT44PT3				AC164020	AC164305			SW006011	
PIC18C601	68L				PMF18WB1	DAF18-6	XLT68L1	AC174007	AC164308		✓	SW006011	
PIC18C601	64PT				PMF18WB1	DAF18-6	XLT64PT2 or XLT64PT5	AC174008	AC164319		✓	SW006011	

**NOTE:** See complete list of notes on page 108.

**MPLAB® ICE 2000 and MPLAB® ICE 4000 Emulator Systems, PRO MATE® II Programmer Socket Modules, MPLAB® In-Circuit Debugger, Software Tools, Programmers and Demonstration Boards (continued)**

Part Number	MPLAB® ICE 2000 System <sup>(1)</sup>				MPLAB® ICE 4000 System <sup>(2)</sup>				MPLAB® CXX Compiler	Demonstration Boards or Evaluation Kits		
	Lead Count/ Pkg Type	Processor Module	Device Adapters	Transition Socket	Processor Module	Device Adapters	Transition Socket	PROMATE® II Socket Module <sup>(3,4)</sup>			MPLAB® ICD 2 <sup>(6)</sup>	PICSTART® Plus <sup>(5)</sup>
<b>PICmicro® Microcontroller Development Tools (continued)</b>												
PIC18C658	68L	PCM18XB0	DVA18XL680	XLT64PT2 or XLT64PT5			AC174007	AC164308	✓ <sup>(7)</sup>		SW006011	DM163007
PIC18C658	64PT	PCM18XB0	DVA18PQ640				AC174008	AC164319			SW006011	
PIC18C801	80PT				PMF18WB1	XLT80PT or XLT80PT3	AC174011	AC164320	✓		SW006011	
PIC18C801	84L				PMF18WB1	XLT84L1	AC174012	AC164310	✓		SW006011	
PIC18C858	84L	PCM18XB0	DVA18XL840	XLT80PT or XLT80PT3			AC174012	AC164310	✓ <sup>(7)</sup>		SW006011	DM163007
PIC18C858	80PT	PCM18XB0	DVA18PQ800				AC174011	AC164320			SW006011	
PIC18F242	28SP	PCM18XH2	DVA16XP282 or DVA18XP280		PMF18WC1	ACICE0204	AC164012	AC164301	✓		SW006011	DM163022
PIC18F242	28SO	PCM18XH2	DVA16XP282 or DVA18XP280	XLT28SO	PMF18WC1	XLT28SO	AC164017	AC164302	✓		SW006011	
PIC18F248	28SP	PCM18XD1	DVA16XP282	XLT28SO			AC164012	AC164301	✓		SW006011	DM163011
PIC18F248	28SO	PCM18XD1	DVA16XP282				AC164017	AC164302	✓		SW006011	
PIC18F252	28SP	PCM18XH2	DVA16XP282 or DVA18XP280		PMF18WC1	ACICE0204	AC164012	AC164301	✓		SW006011	DM163022
PIC18F252	28SO	PCM18XH2	DVA16XP282 or DVA18XP280	XLT28SO	PMF18WC1	XLT28SO	AC164017	AC164302	✓		SW006011	
PIC18F258	28SP	PCM18XD1	DVA16XP282	XLT28SO			AC164012	AC164301	✓		SW006011	DM163011
PIC18F258	28SO	PCM18XD1	DVA16XP282				AC164017	AC164302	✓		SW006011	
PIC18F442	40P	PCM18XH2	DVA16XP401 or DVA18XP400		PMF18WC1	ACICE0206	AC164012	AC164301	✓		SW006011	DM163022
PIC18F442	44L	PCM18XH2	DVA16XL441		PMF18WC1	XLT44L2	AC164013	AC164309	✓		SW006011	
PIC18F442	44PT	PCM18XH2	DVA16PQ441 or DVA18PQ440	XLT44PT or XLT44PT3	PMF18WC1	XLT44PT or XLT44PT3	AC164020	AC164305	✓		SW006011	
PIC18F448	40P	PCM18XD1	DVA16XP401				AC164012	AC164301	✓		SW006011	DM163011
PIC18F448	44L	PCM18XD1	DVA16XL441	XLT44PT or XLT44PT3			AC164013	AC164309	✓		SW006011	
PIC18F448	44PT	PCM18XD1	DVA16PQ441				AC164020	AC164305	✓		SW006011	
PIC18F452	40P	PCM18XH2	DVA16XP401		PMF18WC1	ACICE0206	AC164012	AC164301	✓		SW006011	DM163022
PIC18F452	44L	PCM18XH2	DVA16XL441		PMF18WC1	XLT44L2	AC164013	AC164309	✓		SW006011	
PIC18F452	44PT	PCM18XH2	DVA16PQ441	XLT44PT or XLT44PT3	PMF18WC1	XLT44PT or XLT44PT3	AC164020	AC164305	✓		SW006011	

**NOTE:** See complete list of notes on page 108.



**MPLAB® ICE 2000 and MPLAB® ICE 4000 Emulator Systems, PRO MATE® II Programmer Socket Modules, MPLAB® In-Circuit Debugger, Software Tools, Programmers and Demonstration Boards (continued)**

		MPLAB® ICE 2000 System <sup>(1)</sup>				MPLAB® ICE 4000 System <sup>(2)</sup>							
Part Number	Lead Count/ Pkg Type	Processor Module	Device Adapters	Transition Socket	Processor Module	Device Adapters	Transition Socket	PRO MATE® II Socket Module <sup>(3,4)</sup>	MPLAB® PM3 Socket Module <sup>(8)</sup>	PICSTART® Plus <sup>(5)</sup>	MPLAB® ICD 2 <sup>(6)</sup>	MPLAB® CXX Compiler	Demonstration Boards or Evaluation Kits
<b>PICmicro® Microcontroller Development Tools (continued)</b>													
PIC18F458	40P	PCM18XD1	DVA16XP401					AC164012	AC164301	✓	✓	SW006011	DM163011
PIC18F458	44L	PCM18XD1	DVA16XL441	XLT44PT or XLT44PT3				AC164013	AC164309	✓	✓	SW006011	
PIC18F458	44PT	PCM18XD1	DVA16PQ441					AC164020	AC164305	✓	✓	SW006011	
PIC18F1220	18P	PCM18XJ0	DVA18XP180		PMF18WV00	DAF18-4	ACICE0202	AC164010	AC164301	✓	✓	SW006011	DM163014
PIC18F1220	18SO	PCM18XJ0	DVA18XP180	XLT18SO	PMF18WV00	DAF18-4	XLT18SO	AC164010	AC164302	✓	✓	SW006011	
PIC18F1220	20SS	PCM18XJ0	DVA18XP180	XLT20SS	PMF18WV00	DAF18-4	XLT20SS	AC164018	AC164307	✓	✓	SW006011	
PIC18F1220	28ML	PCM18XJ0	DVA18XP180	XLT28QFN3	PMF18WV00	DAF18-4	XLT28QFN3	AC164010 +AC164033	AC164322	✓	✓	SW006011	
PIC18F1230	18P							TBD	AC164301*	✓*	✓*	SW006011*	
PIC18F1230	18SO							TBD	AC164302*	✓*	✓*	SW006011*	
PIC18F1230	20SS							TBD	AC164307*	✓*	✓*	SW006011*	
PIC18F1230	28ML							TBD	AC164322*	✓*	✓*	SW006011*	
PIC18F1231	18P							TBD	AC164301*	✓*	✓*	SW006011*	
PIC18F1231	18SO							TBD	AC164302*	✓*	✓*	SW006011*	
PIC18F1231	20SS							TBD	AC164307*	✓*	✓*	SW006011*	
PIC18F1231	28ML							TBD	AC164322*	✓*	✓*	SW006011*	
PIC18F1320	18P	PCM18XJ0	DVA18XP180		PMF18WV00	DAF18-4	ACICE0202	AC164010	AC164301	✓	✓	SW006011	DM163014
PIC18F1320	18SO	PCM18XJ0	DVA18XP180	XLT18SO	PMF18WV00	DAF18-4	XLT18SO	AC164010	AC164302	✓	✓	SW006011	
PIC18F1320	20SS	PCM18XJ0	DVA18XP180	XLT20SS	PMF18WV00	DAF18-4	XLT20SS	AC164018	AC164307	✓	✓	SW006011	
PIC18F1320	28ML	PCM18XJ0	DVA18XP180	XLT28QFN3	PMF18WV00	DAF18-4	XLT28QFN3	AC164010 +AC164033	AC164322	✓	✓	SW006011	
PIC18F1330	18P							TBD	AC164301*	✓*	✓*	SW006011*	
PIC18F1330	18SO							TBD	AC164302*	✓*	✓*	SW006011*	
PIC18F1330	20SS							TBD	AC164307*	✓*	✓*	SW006011*	
PIC18F1330	28ML							TBD	AC164322*	✓*	✓*	SW006011*	
PIC18F1331	18P							TBD	AC164301*	✓*	✓*	SW006011*	
PIC18F1331	18SO							TBD	AC164302*	✓*	✓*	SW006011*	
PIC18F1331	20SS							TBD	AC164307*	✓*	✓*	SW006011*	
PIC18F1331	28ML							TBD	AC164322*	✓*	✓*	SW006011*	
PIC18F2220	28SP	PCM18XH2	DVA18XP280			DAF18-4	ACICE0204	AC164012	AC164301	✓	✓	SW006011	
PIC18F2220	28SO	PCM18WC1	DVA18XP280	XLT28SO	PMF18WC1	DAF18-4	XLT28SO	AC164017	AC164302	✓	✓	SW006011	

**NOTE:** See complete list of notes on page 108.



**MPLAB® ICE 2000 and MPLAB® ICE 4000 Emulator Systems, PRO MATE® II Programmer Socket Modules, MPLAB® In-Circuit Debugger, Software Tools, Programmers and Demonstration Boards (continued)**

Part Number	Lead Count/ Pkg Type	MPLAB® ICE 2000 System <sup>(1)</sup>			MPLAB® ICE 4000 System <sup>(2)</sup>			PICSTART® Plus <sup>(5)</sup>	MPLAB® ICD 2 <sup>(6)</sup>	MPLAB® CXX Compiler	Demonstration Boards or Evaluation Kits
		Processor Module	Device Adapters	Transition Socket	Processor Module	Device Adapters	Transition Socket				
<b>PICmicro® Microcontroller Development Tools (continued)</b>											
PIC18F2221	28SP	PCM18XN0	DVA18XP280	XLT28SO	PMF18WH0	DAF18-4	ACICE0204	AC164012*	AC164301*	SW006011	
PIC18F2221	28SO	PCM18XN0	DVA18XP280	XLT28SO	PMF18WH0	DAF18-4	XLT28SO	AC164017*	AC164302*	SW006011	
PIC18F2221	28ML	PCM18XN0	DVA18XP280	XLT28QFN4	PMF18WH0	DAF18-4	XLT28QFN4	AC164322*	AC164322*	SW006011	
PIC18F2320	28SP	PCM18XH2	DVA18XP280	XLT28SO	PMF18WC1	DAF18-4	ACICE0204	AC164012	AC164301	SW006011	
PIC18F2320	28SO	PCM18XH2	DVA18XP280	XLT28SO	PMF18WC1	DAF18-4	XLT28SO	AC164017	AC164302	SW006011	
PIC18F2321	28SP	PCM18XN0	DVA18XP280	XLT28SO	PMF18WH0	DAF18-4	ACICE0204	AC164012*	AC164301*	SW006011	
PIC18F2321	28SO	PCM18XN0	DVA18XP280	XLT28SO	PMF18WH0	DAF18-4	XLT28SO	AC164017*	AC164302*	SW006011	
PIC18F2321	28ML	PCM18XN0	DVA18XP280	XLT28QFN4	PMF18WH0	DAF18-4	XLT28QFN4	AC164322*	AC164322*	SW006011	
PIC18F2331	28SP	PCM18XL0	DVA18XP280	XLT28SO	PMF18WF0	DAF18-4	ACICE0204	AC164035	AC164301	SW006011	DM183011, DM183021
PIC18F2331	28SO	PCM18XL0	DVA18XP280	XLT28SO	PMF18WF0	DAF18-4	XLT28SO	AC164017	AC164302	SW006011	
PIC18F2331	28MM	PCM18XL0	DVA18XP280	XLT28QFN4	PMF18WF0	DAF18-4	XLT28QFN4	AC164035 +AC164031	AC164322	SW006011	
PIC18F2410	28SP	PCM18XN0	DVA18XP280	XLT28SO	PMF18WH0	DAF18-4	ACICE0204	AC164012	AC164301	SW006011	
PIC18F2410	28SO	PCM18XN0	DVA18XP280	XLT28SO	PMF18WH0	DAF18-4	XLT28SO	AC164017	AC164302	SW006011	
PIC18F2410	28ML	PCM18XN0	DVA18XP280	XLT28QFN4	PMF18WH0	DAF18-4	XLT28QFN4	AC164035 +AC164031	AC164322	SW006011	
PIC18F2420	28SP	PCM18XN0	DVA18XP280	XLT28SO	PMF18WH0	DAF18-4	ACICE0204	AC164012	AC164301	SW006011	
PIC18F2420	28SO	PCM18XN0	DVA18XP280	XLT28SO	PMF18WH0	DAF18-4	XLT28SO	AC164017	AC164302	SW006011	
PIC18F2420	28ML	PCM18XN0	DVA18XP280	XLT28QFN4	PMF18WH0	DAF18-4	XLT28QFN4	AC164035 +AC164031	AC164322	SW006011	
PIC18F2431	28SP	PCM18XL0	DVA18XP280	XLT28SO	PMF18WF0	DAF18-4	ACICE0204	AC164035	AC164301	SW006011	DM183011, DM183021
PIC18F2431	28SO	PCM18XL0	DVA18XP280	XLT28SO	PMF18WF0	DAF18-4	XLT28SO	AC164017	AC164302	SW006011	
PIC18F2431	28MM	PCM18XL0	DVA18XP280	XLT28QFN4	PMF18WF0	DAF18-4	XLT28QFN4	AC164035 +AC164031	AC164322	SW006011	
PIC18F2439	28P							AC164012		SW006011	
PIC18F2439	28SO							AC164017		SW006011	
PIC18F2455	28SP	PCM18XR0	DVA18XP280	XLT28SO	PMF18WL0	DAF18-4	ACICE0204	AC164012	AC164301	SW006011	DM163025
PIC18F2455	28SO	PCM18XR0	DVA18XP280	XLT28SO	PMF18WL0	DAF18-4	XLT28SO	AC164017	AC164302	SW006011	DM163025

**NOTE:** See complete list of notes on page 108.

## Development Systems Products

### MPLAB® ICE 2000 and MPLAB® ICE 4000 Emulator Systems, PRO MATE® II Programmer Socket Modules, MPLAB® In-Circuit Debugger, Software Tools, Programmers and Demonstration Boards (continued)

		MPLAB® ICE 2000 System <sup>(1)</sup>				MPLAB® ICE 4000 System <sup>(2)</sup>							
Part Number	Lead Count/ Pkg Type	Processor Module	Device Adapters	Transition Socket	Processor Module	Device Adapters	Transition Socket	PRO MATE® II Socket Module <sup>(3,4)</sup>	MPLAB® PM3 Socket Module <sup>(8)</sup>	PICSTART® Plus <sup>(5)</sup>	MPLAB® ICD 2 <sup>(6)</sup>	MPLAB® CXX Compiler	Demonstration Boards or Evaluation Kits
<b>PICmicro® Microcontroller Development Tools (continued)</b>													
PIC18F2480	28SP	PCM18XP0	DVA18XP280		PMF18WJ0	DAF18-4	ACICE0204	AC164012	AC164301	✓*	✓	SW006011	DM163011
PIC18F2480	28SO	PCM18XP0	DVA18XP280	XLT28SO	PMF18WJ0	DAF18-4	XLT28SO	AC164017	AC164302		✓	SW006011	
PIC18F2480	28MM	PCM18XP0	DVA18XP280	XLT28QFN4	PMF18WJ0	DAF18-4	XLT28QFN4	AC164012 +AC164031	AC164322	AC164031	✓	SW006011	
PIC18F24J10	28SP								AC164329*		AC162067** +XLT28SS <sup>(9)</sup>	SW006011	
PIC18F24J10	28SO								AC164332*		AC162067** +XLT28SS <sup>(9)</sup>	SW006011	
PIC18F24J10	28SS								AC164331*		AC162067** +XLT28SS <sup>(9)</sup>	SW006011	
PIC18F2510	28SP	PCM18XN0	DVA18XP280		PMF18WH0	DAF18-4	ACICE0204	AC164012	AC164301	✓	✓	SW006011	DM163022
PIC18F2510	28SO	PCM18XN0	DVA18XP280	XLT28SO	PMF18WH0	DAF18-4	XLT28SO	AC164017	AC164302		✓	SW006011	
PIC18F2510	28ML	PCM18XN0	DVA18XP280	XLT28QFN4	PMF18WH0	DAF18-4	XLT28QFN4	AC164012 +AC164031	AC164322	AC164031	✓	SW006011	
PIC18F2515	28SP	PCM18XN0	DVA18XP280		PMF18WH0	DAF18-4	ACICE0204	AC164012	AC164301	✓	✓	SW006011	
PIC18F2515	28SO	PCM18XN0	DVA18CP280	XLT28SO	PMF18WH0	DAF18-4	XLT28SO	AC164017	AC164302		✓	SW006011	
PIC18F2520	28SP	PCM18XN0	DVA18XP280		PMF18WH0	DAF18-4	ACICE0204	AC164012	AC164301	✓	✓	SW006011	DM163022
PIC18F2520	28SO	PCM18XN0	DVA18XP280	XLT28SO	PMF18WH0	DAF18-4	XLT28SO	AC164017	AC164302		✓	SW006011	
PIC18F2520	28ML	PCM18XN0	DVA18XP280	XLT28QFN4	PMF18WH0	DAF18-4	XLT28QFN4	AC164012 +AC164031	AC164322	AC164031	✓	SW006011	
PIC18F2525	28SP	PCM18XN0	DVA18XP280		PMF18WH0	DAF18-4	ACICE0204	AC164012	AC164301	✓	✓	SW006011	
PIC18F2525	28SO	PCM18XN0	DVA18XP280	XLT28SO	PMF18WH0	DAF18-4	XLT28SO	AC164017	AC164302		✓	SW006011	
PIC18F2539	28P							AC164012			✓	SW006011	
PIC18F2539	28SO							AC164017			✓	SW006011	
PIC18F2550	28SP	PCM18XR0	DVA18XP280		PMF18WL0	DAF18-4	ACICE0204	AC164012	AC164301	✓	✓	SW006011	DM163025
PIC18F2550	28SO	PCM18XR0	DVA18XP280	XLT28SO	PMF18WL0	DAF18-4	XLT28SO	AC164017	AC164302		✓	SW006011	DM163025
PIC18F2580	28SP	PCM18XP0	DVA18XP280		PMF18WJ0	DAF18-4	ACICE0204	AC164012	AC164301	✓	✓	SW006011	DM163011
PIC18F2580	28SO	PCM18XP0	DVA18XP280	XLT28SO	PMF18WJ0	DAF18-4	XLT28SO	AC164017	AC164302		✓	SW006011	
PIC18F2580	28MM	PCM18XP0	DVA18XP280	XLT28QFN4	PMF18WJ0	DAF18-4	XLT28QFN4	AC164012 +AC164031	AC164322	AC164031	✓	SW006011	
PIC18F2585	28SP	PCM18XP0	DVA18XP280		PMF18WJ0	DAF18-4	ACICE0204	AC164012	AC164301	✓	✓	SW006011	DM163011
PIC18F2585	28SO	PCM18XP0	DVA18XP280	XLT28SO	PMF18WJ0	DAF18-4	XLT28SO	AC164017	AC164302		✓	SW006011	

NOTE: See complete list of notes on page 108.

**MPLAB® ICE 2000 and MPLAB® ICE 4000 Emulator Systems, PRO MATE® II Programmer Socket Modules, MPLAB® In-Circuit Debugger, Software Tools, Programmers and Demonstration Boards (continued)**

Part Number	MPLAB® ICE 2000 System <sup>(1)</sup>				MPLAB® ICE 4000 System <sup>(2)</sup>				MPLAB® ICD 2 <sup>(6)</sup>	PICSTART® Plus <sup>(5)</sup>	MPLAB® CXX Compiler	Demonstration Boards or Evaluation Kits
	Lead Count/ Pkg Type	Processor Module	Device Adapters	Transition Socket	Processor Module	Device Adapters	Transition Socket	PROMATE® II Socket Module <sup>(3,4)</sup>				
<b>PICmicro® Microcontroller Development Tools (continued)</b>												
PIC18F25J10	28SP										SW006011	
PIC18F25J10	28SO										SW006011	AC162067** +XLT28SO <sup>(9)</sup>
PIC18F25J10	28SS										SW006011	AC162067** +XLT28SS <sup>(9)</sup>
PIC18F2610	28SP	PCM18XN0	DVA18XP280		DAF18-4	ACICE0204	AC164012	AC164301	✓		SW006011	✓
PIC18F2610	28SO	PCM18XN0	DVA18XP280	XLT28SO	DAF18-4	XLT28SO	AC164017	AC164302	✓		SW006011	✓
PIC18F2620	28SP	PCM18XN0	DVA18XP280		DAF18-4	ACICE0204	AC164012	AC164301	✓		SW006011	✓
PIC18F2620	28SO	PCM18XN0	DVA18XP280	XLT28SO	DAF18-4	XLT28SO	AC164017	AC164302	✓		SW006011	✓
PIC18F2680	28SP	PCM18XP0	DVA18XP280		DAF18-4	ACICE0204	AC164012	AC164301	✓		SW006011	✓
PIC18F2680	28SO	PCM18XP0	DVA18XP280	XLT28SO	DAF18-4	XLT28SO	AC164017	AC164302	✓		SW006011	✓
PIC18F2682	28SO							AC164302*	✓*		SW006011*	✓*
PIC18F2682	28P							AC164301*	✓*		SW006011*	✓*
PIC18F2685	28SO							AC164302*	✓*		SW006011*	✓*
PIC18F2685	28P							AC164301*	✓*		SW006011*	✓*
PIC18F4220	40P	PCM18XH2	DVA18XP400		DAF18-4	ACICE0206	AC164012	AC164301	✓		SW006011	✓
PIC18F4220	44ML	PCM18XH2	DVA18XP400	XLT44QFN2	DAF18-4	XLT44QFN2	AC164012 +AC164034	AC164322	✓	AC164034	SW006011	✓
PIC18F4220	44PT	PCM18XH2	DVA18XPQ440	XLT44PT or XLT44PT3	DAF18-5	XLT44PT or XLT44PT3	AC164020	AC164305	✓		SW006011	✓
PIC18F4221	40P	PCM18XN0	DVA18XP400		DAF18-4	ACICE0206	AC164012*	AC164301*	✓		SW006011	✓
PIC18F4221	44PT	PCM18XN0	DVA18XPQ440	XLT44PT or XLT44PT3	DAF18-5	XLT44PT or XLT44PT3	AC164020*	AC164305*	✓		SW006011	✓
PIC18F4221	44ML	PCM18XN0	DVA18XP400	XLT44QFN2	DAF18-4	XLT44QFN2		AC164322*	✓		SW006011	✓
PIC18F4320	40P	PCM18XH2	DVA18XP400		DAF18-4	ACICE0206	AC164012	AC164301	✓		SW006011	✓
PIC18F4320	44ML	PCM18XH2	DVA18XP400	XLT44QFN2	DAF18-4	XLT44QFN2	AC164012 +AC164034	AC164322	✓	AC164034	SW006011	✓
PIC18F4320	44PT	PCM18XH2	DVA18XPQ440	XLT44PT or XLT44PT3	DAF18-5	XLT44PT or XLT44PT3	AC164020	AC164305	✓		SW006011	✓
PIC18F4321	40P	PCM18XN0	DVA18XP400		DAF18-4	ACICE0206	AC164012*	AC164301*	✓		SW006011	✓
PIC18F4321	44PT	PCM18XN0	DVA18XPQ440	XLT44PT or XLT44PT3	DAF18-5	XLT44PT or XLT44PT3	AC164020*	AC164305*	✓		SW006011	✓
PIC18F4321	44ML	PCM18XN0	DVA18XP400	XLT44QFN2	DAF18-4	XLT44QFN2		AC164322*	✓		SW006011	✓

**NOTE:** See complete list of notes on page 108.

## Development Systems Products

### MPLAB® ICE 2000 and MPLAB® ICE 4000 Emulator Systems, PRO MATE® II Programmer Socket Modules, MPLAB® In-Circuit Debugger, Software Tools, Programmers and Demonstration Boards (continued)

			MPLAB® ICE 2000 System <sup>(1)</sup>				MPLAB® ICE 4000 System <sup>(2)</sup>						
Part Number	Lead Count/ Pkg Type	Processor Module	Device Adapters	Transition Socket	Processor Module	Device Adapters	Transition Socket	PRO MATE® II Socket Module <sup>(3,4)</sup>	MPLAB® PM3 Socket Module <sup>(8)</sup>	PICSTART® Plus <sup>(5)</sup>	MPLAB® ICD 2 <sup>(6)</sup>	MPLAB® CXX Compiler	Demonstration Boards or Evaluation Kits
<b>PICmicro® Microcontroller Development Tools (continued)</b>													
PIC18F4331	40P	PCM18XL0	DVA18XP400	XLT44PT or XLT44PT3	PMF18WF0	DAF18-4	ACICE0206 XLT44PT or XLT44PT3	AC164012	AC164301	✓	✓	SW006011	DM183011
PIC18F4331	44PT	PCM18XL0	DVA18PQ440	XLT44PT or XLT44PT3	PMF18WF0	DAF18-5	XLT44PT or XLT44PT3	AC164020	AC164305	✓	✓	SW006011	
PIC18F4331	44ML	PCM18XL0	DVA18XP400	XLT44QFN2	PMF18WF0	DAF18-4	XLT44QFN2	AC164012 +AC164034	AC164322	✓	✓	SW006011	
PIC18F4410	40P	PCM18XN0	DVA18XP400	XLT44PT or XLT44PT3	PMF18WH0	DAF18-4	ACICE0206	AC164012	AC164301	✓	✓	SW006011	
PIC18F4410	44PT	PCM18XN0	DVA18PQ440	XLT44PT or XLT44PT3	PMF18WH0	DAF18-5	XLT44PT or XLT44PT3	AC164020	AC164305	✓	✓	SW006011	
PIC18F4410	44ML	PCM18XN0	DVA18XP400	XLT44QFN2	PMF18WH0	DAF18-4	XLT44QFN2	AC164012 +AC164034	AC164322	✓	✓	SW006011	
PIC18F4420	40P	PCM18XN0	DVA18XP400	XLT44PT or XLT44PT3	PMF18WH0	DAF18-4	ACICE0206	AC164012	AC164301	✓	✓	SW006011	
PIC18F4420	44PT	PCM18XN0	DVA18PQ440	XLT44PT or XLT44PT3	PMF18WH0	DAF18-5	XLT44PT or XLT44PT3	AC164020	AC164305	✓	✓	SW006011	
PIC18F4420	44ML	PCM18XN0	DVA18XP400	XLT44QFN2	PMF18WH0	DAF18-4	XLT44QFN2	AC164012 +AC164034	AC164322	✓	✓	SW006011	
PIC18F4431	40P	PCM18XL0	DVA18XP400	XLT44PT or XLT44PT3	PMF18WF0	DAF18-4	ACICE0206	AC164012	AC164301	✓	✓	SW006011	DM183011
PIC18F4431	44PT	PCM18XL0	DVA18PQ440	XLT44PT or XLT44PT3	PMF18WF0	DAF18-5	XLT44PT or XLT44PT3	AC164020	AC164305	✓	✓	SW006011	
PIC18F4431	44ML	PCM18XL0	DVA18XP400	XLT44QFN2	PMF18WF0	DAF18-4	XLT44QFN2	AC164012 +AC164034	AC164322	✓	✓	SW006011	
PIC18F4439	40P							AC164012		✓	✓	SW006011	
PIC18F4439	44ML							AC164012 +AC164034		✓	✓	SW006011	
PIC18F4439	44PT							AC164020		✓	✓	SW006011	
PIC18F4455	40P	PCM18XR0	DVA18XP400	XLT44QFN2	PMF18WL0	DAF18-4	ACICE0206	AC164012	AC164301	✓	✓	SW006011	DM163025
PIC18F4455	44ML	PCM18XR0	DVA18XP400	XLT44QFN2	PMF18WL0	DAF18-4	XLT44QFN2	AC164012 +AC164034	AC164322	✓	✓	SW006011	DM163025
PIC18F4455	44PT	PCM18XR0	DVA18PQ440	XLT44PT or XLT44PT3	PMF18WL0	DAF18-5	XLT44PT or XLT44PT3	AC164020	AC164305	✓	✓	SW006011	DM163025
PIC18F4480	40P	PCM18XP0	DVA18XP400	XLT44PT or XLT44PT3	PMF18WJ0	DAF18-4	ACICE0206	AC164012	AC164301	✓*	✓	SW006011	DM163011
PIC18F4480	44PT	PCM18XP0	DVA18PQ440	XLT44PT or XLT44PT3	PMF18WJ0	DAF18-5	XLT44PT or XLT44PT3	AC164020	AC164305	✓	✓	SW006011	
PIC18F4480	44ML	PCM18XP0	DVA18XP400	XLT44QFN2	PMF18WJ0	DAF18-4	XLT44QFN2	AC164012 +AC164034	AC164322	✓	✓	SW006011	

NOTE: See complete list of notes on page 108.

**MPLAB® ICE 2000 and MPLAB® ICE 4000 Emulator Systems, PRO MATE® II Programmer Socket Modules, MPLAB® In-Circuit Debugger, Software Tools, Programmers and Demonstration Boards (continued)**

Part Number	Lead Count/ Pkg Type	MPLAB® ICE 2000 System <sup>(1)</sup>			MPLAB® ICE 4000 System <sup>(2)</sup>			PICSTART® Plus <sup>(5)</sup>	MPLAB® ICD 2 <sup>(6)</sup>	MPLAB® CXX Compiler	Demonstration Boards or Evaluation Kits
		Processor Module	Device Adapters	Transition Socket	Processor Module	Device Adapters	Transition Socket				
<b>PICmicro® Microcontroller Development Tools (continued)</b>											
PIC18F44J10	40P								AC162067** +XLT44PT <sup>(8)</sup> XLT44PT3 <sup>(9)</sup>	SW006011	
PIC18F44J10	44PT								AC162067** +XLT44PT <sup>(8)</sup> XLT44PT3 <sup>(9)</sup>	SW006011	
PIC18F44J10	44ML								AC162067** +XLT44QFN2 <sup>(9)</sup>	SW006011	
PIC18F4510	40P	PCMI8XN0	DVA18XP400		PMF18WH0	DAF18-4	ACICE0206	AC164012	AC164301	SW006011	DM163022
PIC18F4510	44PT	PCMI8XN0	DVA18PQ440	XLT44PT or XLT44PT3	PMF18WH0	DAF18-5	XLT44PT or XLT44PT3	AC164020	AC164305	SW006011	
PIC18F4510	44ML	PCMI8XN0	DVA18XP400	XLT44QFN2	PMF18WH0	DAF18-4	XLT44QFN2	AC164012 +AC164034	AC164322	SW006011	
PIC18F4515	40P	PCMI8XN0	DVA18XP400		PMF18WH0	DAF18-4	ACICE0206	AC164012	AC164301	SW006011	
PIC18F4515	44PT	PCMI8XN0	DVA18PQ440	XLT44PT or XLT44PT3	PMF18WH0	DAF18-5	XLT44PT or XLT44PT3	AC164020	AC164305	SW006011	
PIC18F4515	44ML	PCMI8XN0	DVA18XP400	XLT44QFN2	PMF18WH0	DAF18-4	XLT44QFN2	AC164012 +AC164034	AC164322	SW006011	
PIC18F4520	40P	PCMI8XN0	DVA18XP400		PMF18WH0	DAF18-4	ACICE0206	AC164012	AC164301	SW006011	DM163022
PIC18F4520	44PT	PCMI8XN0	DVA18PQ440	XLT44PT or XLT44PT3	PMF18WH0	DAF18-5	XLT44PT or XLT44PT3	AC164020	AC164305	SW006011	
PIC18F4520	44ML	PCMI8XN0	DVA18XP400	XLT44QFN2	PMF18WH0	DAF18-4	XLT44QFN2	AC164012 +AC164034	AC164322	SW006011	
PIC18F4525	40P	PCMI8XN0	DVA18XP400		PMF18WH0	DAF18-4	ACICE0206	AC164012	AC164301	SW006011	
PIC18F4525	44PT	PCMI8XN0	DVA18PQ440	XLT44PT or XLT44PT3	PMF18WH0	DAF18-5	XLT44PT or XLT44PT3	AC164020	AC164305	SW006011	
PIC18F4525	44ML	PCMI8XN0	DVA18XP400	XLT44QFN2	PMF18WH0	DAF18-4	XLT44QFN2	AC164012 +AC164034	AC164322	SW006011	
PIC18F4539	40P							AC164012		SW006011	
PIC18F4539	44ML							AC164012 +AC164034		SW006011	
PIC18F4539	44PT							AC164020		SW006011	
PIC18F4550	40P	PCMI8XR0	DVA18XP400		PMF18WL0	DAF18-4	ACICE0206	AC164012	AC164301	SW006011	DM163025
PIC18F4550	44ML	PCMI8XR0	DVA18PQ440	XLT44QFN2	PMF18WL0	DAF18-4	XLT44QFN2	AC164012 +AC164034	AC164322	SW006011	DM163025
PIC18F4550	44PT	PCMI8XR0	DVA18PQ440	XLT44PT or XLT44PT3	PMF18WL0	DAF18-5	XLT44PT or XLT44PT3	AC164020	AC164305	SW006011	DM163025

NOTE: See complete list of notes on page 108.

**MPLAB® ICE 2000 and MPLAB® ICE 4000 Emulator Systems, PRO MATE® II Programmer Socket Modules, MPLAB® In-Circuit Debugger, Software Tools, Programmers and Demonstration Boards (continued)**

			MPLAB® ICE 2000 System <sup>(1)</sup>				MPLAB® ICE 4000 System <sup>(2)</sup>							
Part Number	Lead Count/ Pkg Type	Processor Module	Device Adapters	Transition Socket	Processor Module	Device Adapters	Transition Socket	PRO MATE® II Socket Module <sup>(3,4)</sup>	MPLAB® PM3 Socket Module <sup>(8)</sup>	PICSTART® Plus <sup>(5)</sup>	MPLAB® ICD 2 <sup>(6)</sup>	MPLAB® CXX Compiler	Demonstration Boards or Evaluation Kits	
<b>PICmicro® Microcontroller Development Tools (continued)</b>														
PIC18F4580	40P	PCM18XP0	DVA18XP400		PMF18WJ0	DAF18-4	ACICE0206	AC164012	AC164301	✓	✓	SW006011	DM163011	
PIC18F4580	44PT	PCM18XP0	DVA18PQ440	XLT44PT or XLT44PT3	PMF18WJ0	DAF18-5	XLT44PT or XLT44PT3	AC164020	AC164305	✓	✓	SW006011		
PIC18F4580	44ML	PCM18XP0	DVA18XP400	XLT44QFN2	PMF18WJ0	DAF18-4	XLT44QFN2	AC164012 +AC164034	AC164322	AC164034	✓	SW006011		
PIC18F4585	40P	PCM18XP0	DVA18XP400		PMF18WJ0	DAF18-4	ACICE0206	AC164012	AC164301	✓	✓	SW006011	DM163011	
PIC18F4585	44PT	PCM18XP0	DVA18PQ440	XLT44PT or XLT44PT3	PMF18WJ0	DAF18-5	XLT44PT or XLT44PT3	AC164020	AC164305	✓	✓	SW006011		
PIC18F4585	44ML	PCM18XP0	DVA18XP400	XLT44QFN2	PMF18WJ0	DAF18-4	XLT44QFN2	AC164012 +AC164034	AC164322	AC164034	✓	SW006011		
PIC18F45J10	40P								AC164329*		AC162067** <sup>(9)</sup>	SW006011		
PIC18F45J10	44PT								AC164330*		AC162067** +XLT44PT or XLT44PT3 <sup>(9)</sup>	SW006011		
PIC18F45J10	44ML								TBD		AC162067** +XLT44QFN2 <sup>(9)</sup>	SW006011		
PIC18F4610	40P	PCM18XN0	DVA18XP400		PMF18WH0	DAF18-4	ACICE0206	AC164012	AC164301	✓	✓	SW006011		
PIC18F4610	44PT	PCM18XN0	DVA18PQ440	XLT44PT or XLT44PT3	PMF18WH0	DAF18-5	XLT44PT or XLT44PT3	AC164020	AC164305	✓	✓	SW006011		
PIC18F4610	44ML	PCM18XN0	DVA18XP400	XLT44QFN2	PMF18WH0	DAF18-4	XLT44QFN2	AC164012 +AC164034	AC164322	AC164034	✓	SW006011		
PIC18F4620	40P	PCM18XN0	DVA18XP400		PMF18WH0	DAF18-4	ACICE0206	AC164012	AC164301	✓	✓	SW006011	DM163026, DM163027-2	
PIC18F4620	44PT	PCM18XN0	DVA18PQ440	XLT44PT or XLT44PT3	PMF18WH0	DAF18-5	XLT44PT or XLT44PT3	AC164020	AC164305	✓	✓	SW006011		
PIC18F4620	44ML	PCM18XN0	DVA18XP400	XLT44QFN2	PMF18WH0	DAF18-4	XLT44QFN2	AC164012 +AC164034	AC164322	AC164034	✓	SW006011		
PIC18F4680	40P	PCM18XP0	DVA18XP400		PMF18WJ0	DAF18-4	ACICE0206	AC164012	AC164301	✓	✓	SW006011	DM163011	
PIC18F4680	44PT	PCM18XP0	DVA18PQ440	XLT44PT or XLT44PT3	PMF18WJ0	DAF18-5	XLT44PT or XLT44PT3	AC164020	AC164305	✓	✓	SW006011		
PIC18F4680	44ML	PCM18XP0	DVA18XP400	XLT44QFN2	PMF18WJ0	DAF18-4	XLT44QFN2	AC164012 +AC164034	AC164322	AC164034	✓	SW006011		
PIC18F4682	40P								AC164301*		✓*	SW006011*		
PIC18F4682	44PT								AC164305*		✓*	SW006011*		
PIC18F4682	44ML								AC164322*		✓*	SW006011*		

**NOTE:** See complete list of notes on page 108.

**MPLAB® ICE 2000 and MPLAB® ICE 4000 Emulator Systems, PRO MATE® II Programmer Socket Modules, MPLAB® In-Circuit Debugger, Software Tools, Programmers and Demonstration Boards (continued)**

Part Number	Lead Count/ Pkg Type	MPLAB® ICE 2000 System <sup>(1)</sup>			MPLAB® ICE 4000 System <sup>(2)</sup>			PICSTAR <sup>®</sup> Plus <sup>(5)</sup>	MPLAB® ICD 2 <sup>(6)</sup>	MPLAB® CXX Compiler	Demonstration Boards or Evaluation Kits
		Processor Module	Device Adapters	Transition Socket	Processor Module	Device Adapters	Transition Socket				
<b>PICmicro® Microcontroller Development Tools (continued)</b>											
PIC18F4685	44ML								✓*	SW006011*	
PIC18F4685	44PT								✓*	SW006011*	
PIC18F4685	40P								✓*	SW006011*	
PIC18F6310	64PT	PCM18XQ0	DVA1003	XL164PT2 or XL164PT5	PMF18WK0	DAF18-6	XL164PT2 or XL164PT5		✓	SW006011	
PIC18F6390	64PT	PCM18XQ0	DVA1003	XL164PT2 or XL164PT5	PMF18WK0	DAF18-6	XL164PT2 or XL164PT5		✓	SW006011	DM163028
PIC18F6410	64PT	PCM18XQ0	DVA1003	XL164PT2 or XL164PT5	PMF18WK0	DAF18-6	XL164PT2 or XL164PT5		✓	SW006011	
PIC18F6490	64PT	PCM18XQ0	DVA1003	XL164PT2 or XL164PT5	PMF18WK0	DAF18-6	XL164PT2 or XL164PT5		✓	SW006011	DM163028
PIC18F6520	64PT	PCM18XE1	DVA18PQ640	XL164PT2 or XL164PT5	PMF18WA2	DAF18-6	XL164PT2 or XL164PT5		✓	SW006011	DM183022
PIC18F6525	64PT	PCM18XK0	DVA18PQ802	XL164PT2 or XL164PT5	PMF18WE0	DAF18-6	XL164PT2 or XL164PT5		✓	SW006011	
PIC18F6527	64PT	PCM18XS0	DVA1003	XL164PT2 or XL164PT5	PMF18WS0	DAF18-6	XL164PT2 or XL164PT5		✓	SW006011	
PIC18F6585	68L	PCM18XK0	DVA18PQ802	XL168L1	PMF18WE0	DAF18-6	XL168L1		✓	SW006011	DM163015
PIC18F6585	64PT	PCM18XK0	DVA18PQ802	XL164PT2 or XL164PT5	PMF18WE0	DAF18-6	XL164PT2 or XL164PT5		✓	SW006011	DM163015
PIC18F65J10	64PT								AC162062 <sup>(9)</sup>	SW006011	DM183022
PIC18F65J15	64PT								AC162062 <sup>(9)</sup>	SW006011	DM183022
PIC18F6620	64PT	PCM18XE1	DVA18PQ640	XL164PT2 or XL164PT5	PMF18WA2	DAF18-6	XL164PT2 or XL164PT5		✓	SW006011	DM183022
PIC18F6621	64PT	PCM18XK0	DVA18PQ802	XL164PT2 or XL164PT5	PMF18WE0	DAF18-6	XL164PT2 or XL164PT5		✓	SW006011	
PIC18F6622	64PT	PCM18XS0	DVA1003	XL164PT2 or XL164PT5	PMF18WS0	DAF18-6	XL164PT2 or XL164PT5		✓	SW006011	
PIC18F6627	64PT	PCM18XS0	DVA1003	XL164PT2 or XL164PT5	PMF18WS0	DAF18-6	XL164PT2 or XL164PT5		✓	SW006011	DM183022
PIC18F6680	68L	PCM18XK0	DVA18PQ802	XL168L1	PMF18WE0	DAF18-6	XL168L1		✓	SW006011	DM163015
PIC18F6680	64PT	PCM18XK0	DVA18PQ802	XL164PT2 or XL164PT5	PMF18WE0	DAF18-6	XL164PT2 or XL164PT5		✓	SW006011	DM163015
PIC18F66J10	64PT								AC162062 <sup>(9)</sup>	SW006011	DM183022
PIC18F66J15	64PT								AC162062 <sup>(9)</sup>	SW006011	DM183022
PIC18F66J60	64PT								AC162064** <sup>(9)</sup>	SW006011*	

NOTE: See complete list of notes on page 108.

**Development  
Systems Products**

**MPLAB® ICE 2000 and MPLAB® ICE 4000 Emulator Systems, PRO MATE® II Programmer Socket Modules, MPLAB® In-Circuit Debugger, Software Tools, Programmers and Demonstration Boards (continued)**

		MPLAB® ICE 2000 System <sup>(1)</sup>				MPLAB® ICE 4000 System <sup>(2)</sup>								
Part Number	Lead Count/ Pkg Type	Processor Module	Device Adapters	Transition Socket	Processor Module	Device Adapters	Transition Socket	PRO MATE® II Socket Module <sup>(3,4)</sup>	MPLAB® PM3 Socket Module <sup>(6)</sup>	PICSTART® Plus <sup>(5)</sup>	MPLAB® ICD 2 <sup>(6)</sup>	MPLAB® CXX Compiler	Demonstration Boards or Evaluation Kits	
<b>PICmicro® Microcontroller Development Tools (continued)</b>														
PIC18F66J65	64PT								AC164327*		AC162064** <sup>(9)</sup>	SW006011*		
PIC18F6720	64PT	PCM18XE1	DVA18PQ640	XLT64PT2 or XLT64PT5	PMF18WA2	DAF18-6	XLT64PT2 or XLT64PT5	AC174008	AC164319	✓ <sup>(7)</sup>	✓	SW006011	DM183022	
PIC18F6722	64PT	PCM18XS0	DVA1003	XLT64PT2 or XLT64PT5	PMF18WS0	DAF18-6	XLT64PT2 or XLT64PT5	AC174008	AC164319		✓	SW006011	DM183022	
PIC18F67J10	64PT								AC164327		AC162062 <sup>(9)</sup>	SW006011	DM183022	
PIC18F67J60	64PT								AC164327*		AC162064** <sup>(9)</sup>	SW006011*		
PIC18F8310	80PT	PCM18XQ0	DVA1003	XLT80PT or XLT80PT3	PMF18WK0	DAF18-6	XLT80PT or XLT80PT3	AC174011	AC164320		✓	SW006011		
PIC18F8390	80PT	PCM18XQ0	DVA1003	XLT80PT or XLT80PT3	PMF18WK0	DAF18-6	XLT80PT or XLT80PT3	AC174011	AC164320		✓	SW006011	DM163028	
PIC18F8410	80PT	PCM18XQ0	DVA1003	XLT80PT or XLT80PT3	PMF18WK0	DAF18-6	XLT80PT or XLT80PT3	AC174011	AC164320		✓	SW006011		
PIC18F8490	80PT	PCM18XQ0	DVA1003	XLT80PT or XLT80PT3	PMF18WK0	DAF18-6	XLT80PT or XLT80PT3	AC174011	AC164320		✓	SW006011	DM163028	
PIC18F8520	80PT	PCM18XE1	DVA18PQ800	XLT80PT or XLT80PT3	PMF18WA2	DAF18-6	XLT80PT or XLT80PT3	AC174011	AC164320		✓	SW006011	DM183022	
PIC18F8525	80PT	PCM18XK0	DVA18PQ802	XLT80PT or XLT80PT3	PMF18WE0	DAF18-6	XLT80PT or XLT80PT3	AC174011	AC164320		✓	SW006011		
PIC18F8527	80PT	PCM18XS0	DVA1003	XLT80PT or XLT80PT3	PMF18WS0	DAF18-6	XLT80PT or XLT80PT3	AC174011	AC164320		✓	SW006011		
PIC18F8585	80PT	PCM18XK0	DVA18PQ802	XLT80PT or XLT80PT3	PMF18WE0	DAF18-6	XLT80PT or XLT80PT3	AC174011	AC164320		✓	SW006011	DM163015	
PIC18F85J10	80PT								AC164328		AC162062 <sup>(9)</sup>	SW006011	DM183022	
PIC18F85J15	80PT								AC164328		AC162062 <sup>(9)</sup>	SW006011	DM183022	
PIC18F8620	80PT	PCM18XE1	DVA18PQ800	XLT80PT or XLT80PT3	PMF18WA2	DAF18-6	XLT80PT or XLT80PT3	AC174011	AC164320	✓ <sup>(7)</sup>	✓	SW006011	DM183022	
PIC18F8621	80PT	PCM18XK0	DVA18PQ802	XLT80PT or XLT80PT3	PMF18WE0	DAF18-6	XLT80PT or XLT80PT3	AC174011	AC164320		✓	SW006011		
PIC18F8622	80PT	PCM18XS0	DVA1003	XLT80PT or XLT80PT3	PMF18WS0	DAF18-6	XLT80PT or XLT80PT3	AC174011	AC164320		✓	SW006011		
PIC18F8627	80PT	PCM18XS0	DVA1003	XLT80PT or XLT80PT3	PMF18WS0	DAF18-6	XLT80PT or XLT80PT3	AC174011	AC164320		✓	SW006011	DM183022	
PIC18F8680	80PT	PCM18XK0	DVA18PQ802	XLT80PT or XLT80PT3	PMF18WE0	DAF18-6	XLT80PT or XLT80PT3	AC174011	AC164320		✓	SW006011	DM163015	
PIC18F86J10	80PT								AC164328		AC162062 <sup>(9)</sup>	SW006011	DM183022	
PIC18F86J15	80PT								AC164328		AC162062 <sup>(9)</sup>	SW006011	DM183022	

**NOTE:** See complete list of notes on page 108.



**MPLAB® ICE 2000 and MPLAB® ICE 4000 Emulator Systems, PRO MATE® II Programmer Socket Modules, MPLAB® In-Circuit Debugger, Software Tools, Programmers and Demonstration Boards (continued)**

		MPLAB® ICE 2000 System <sup>(1)</sup>				MPLAB® ICE 4000 System <sup>(2)</sup>							
Part Number	Lead Count/ Pkg Type	Processor Module	Device Adapters	Transition Socket	Processor Module	Device Adapters	Transition Socket	PROMATE® II Socket Module <sup>(3,4)</sup>	MPLAB® PM3 Socket Module <sup>(6)</sup>	PICSTART® Plus <sup>(5)</sup>	MPLAB® ICD 2 <sup>(6)</sup>	MPLAB® CXX Compiler	Demonstration Boards or Evaluation Kits
<b>PICmicro® Microcontroller Development Tools (continued)</b>													
PIC18F86J60	80PT								AC164328*		AC162064** <sup>(9)</sup>	SW006011*	
PIC18F86J65	80PT			XLT80PT or XLT80PT3					AC164328*		AC162064** <sup>(9)</sup>	SW006011*	
PIC18F8720	80PT	PCM18XE1	DVA18PQ800	XLT80PT or XLT80PT3	PMF18WA2	DAF18-6	XLT80PT or XLT80PT3	AC174011	AC164320	✓ <sup>(7)</sup>	✓	SW006011	DM183022
PIC18F8722	80PT	PCM18XS0	DVA1003	XLT80PT or XLT80PT3	PMF18WS0	DAF18-6	XLT80PT or XLT80PT3	AC174011	AC164320		✓	SW006011	DM183022
PIC18F87J10	80PT								AC164327		AC162062 <sup>(9)</sup>	SW006011	DM183022
PIC18F87J60	80PT								AC164328*		AC162064** <sup>(9)</sup>	SW006011*	
PIC18F96J60	100PT								AC164323*		AC162064** <sup>(9)</sup>	SW006011*	
PIC18F96J65	100PT								AC164323*		AC162064** <sup>(9)</sup>	SW006011*	
PIC18F97J60	100PT								AC164323*		AC162064** <sup>(9)</sup>	SW006011*	
PIC24FJ64GA006	64PT								AC164327**		AC162065**	SW006012*	DM240001
PIC24FJ64GA008	80PT								AC164328*		AC162065**	SW006012*	DM240001
PIC24FJ64GA010	100PT								AC164323		AC162065**	SW006012*	DM240001
PIC24FJ96GA006	64PT								AC164327*		AC162065**	SW006012*	DM240001
PIC24FJ96GA008	80PT								AC164328*		AC162065**	SW006012*	DM240001
PIC24FJ96GA010	100PT								AC164323*		AC162065**	SW006012*	DM240001
PIC24FJ128GA006	64PT								AC164327*		AC162065**	SW006012*	DM240001
PIC24FJ128GA008	80PT								AC164328*		AC162065**	SW006012*	DM240001
PIC24FJ128GA010	100PT								AC164323		AC162065**	SW006012*	DM240001
PIC24HJ128GP206	64PT										✓	SW006012*	
PIC24HJ128GP210	100PT										✓	SW006012*	
PIC24HJ128GP210	100PF										✓	SW006012*	
PIC24HJ128GP306	64PT										✓	SW006012*	
PIC24HJ128GP310	100PT										✓	SW006012*	
PIC24HJ128GP310	100PF										✓	SW006012*	
PIC24HJ128GP506	64PT										✓	SW006012*	
PIC24HJ128GP510	100PT										✓	SW006012*	
PIC24HJ128GP510	100PF										✓	SW006012*	
PIC24HJ256GP206	64PT										✓	SW006012*	
PIC24HJ256GP210	100PT										✓	SW006012*	
PIC24HJ256GP210	100PF										✓	SW006012*	

NOTE: See complete list of notes on page 108.

## Development Systems Products

### MPLAB® ICE 2000 and MPLAB® ICE 4000 Emulator Systems, PRO MATE® II Programmer Socket Modules, MPLAB® In-Circuit Debugger, Software Tools, Programmers and Demonstration Boards (continued)

		MPLAB® ICE 2000 System <sup>(1)</sup>				MPLAB® ICE 4000 System <sup>(2)</sup>							
Part Number	Lead Count/ Pkg Type	Processor Module	Device Adapters	Transition Socket	Processor Module	Device Adapters	Transition Socket	PRO MATE® II Socket Module <sup>(3,4)</sup>	MPLAB® PM3 Socket Module <sup>(8)</sup>	PICSTART® Plus <sup>(5)</sup>	MPLAB® ICD 2 <sup>(6)</sup>	MPLAB® CXX Compiler	Demonstration Boards or Evaluation Kits
<b>PICmicro® Microcontroller Development Tools (continued)</b>													
PIC24HJ256GP610	100PT										✓	SW006012*	
PIC24HJ256GP610	100PF										✓	SW006012*	
PIC24HJ64GP206	64PT										✓	SW006012*	
PIC24HJ64GP210	100PT										✓	SW006012*	
PIC24HJ64GP210	100PF										✓	SW006012*	
PIC24HJ64GP506	64PT										✓	SW006012*	
PIC24HJ64GP510	100PT										✓	SW006012*	
PIC24HJ64GP510	100PF										✓	SW006012*	
<b>rfPIC® Microcontroller Development Tools</b>													
rfPIC12C509AF	20JW	PCM16XA0	DVA12XP080					AC124001	AC164301	✓			
rfPIC12C509AF	20SS	PCM16XA0	DVA12XP080	XLT20SS				AC124002	AC164307	✓			
rfPIC12C509AG	18JW	PCM16XA0	DVA12XP080					AC124001	AC164301	✓ <sup>(7)</sup>			
rfPIC12C509AG	18SO	PCM16XA0	DVA12XP080	XLT18SO				AC124002	AC164302	✓ <sup>(7)</sup>			
rfPIC12F675F	20SS	PCM12XB0	DVA12XP081	XLT20SS				AC124002	AC164307	✓ <sup>(7)*</sup>			DV164102 AC164101 AC164103
rfPIC12F675H	20SS	PCM12XB0	DVA12XP081	XLT20SS				AC124002	AC164307	✓ <sup>(7)*</sup>			
rfPIC12F675K	20SS	PCM12XB0	DVA12XP081	XLT20SS				AC124002	AC164307	✓ <sup>(7)*</sup>			DV164102 AC164102 AC164104
rfRXD0420	32LQ												DV164102
rfRXD0920	32LQ												

**NOTE:** See complete list of notes on page 108.

**MPLAB® ICE 2000 and MPLAB® ICE 4000 Emulator Systems, PRO MATE® II Programmer Socket Modules, MPLAB® In-Circuit Debugger, Software Tools, Programmers and Demonstration Boards (continued)**

Part Number	Lead Count/ Pkg Type	MPLAB® ICE 2000 System <sup>(1)</sup>			MPLAB® ICE 4000 System <sup>(2)</sup>			PICSTART® Plus <sup>(5)</sup>	MPLAB® ICD 2 <sup>(6)</sup>	MPLAB® CXX Compiler	Demonstration Boards or Evaluation Kits
		Processor Module	Device Adapters	Transition Socket	Processor Module	Device Adapters	Transition Socket				
<b>dsPIC® DSC Development Tools</b>											
dsPIC30F2010	28SO				PMF30XA1	DAF30-4	XLT28SO	AC30F004	AC164302	AC164302	DM300017
dsPIC30F2010	28SP				PMF30XA1	DAF30-4	ACICE0204	AC30F004	AC164301	AC164301	DM300017 DM300018
dsPIC30F2010	28MM				PMF30XA1	DAF30-4	XLT28QFN4	AC164322	AC164322	AC164322	DM300018
dsPIC30F2011	18SO				PMF30XA1	DAF30-4	XLT18SO	AC30F005	AC164302	AC164302	DM300018
dsPIC30F2011	18P				PMF30XA1	DAF30-4	ACICE0202	AC30F005	AC164301	AC164301	DM300018
dsPIC30F2011	28ML				PMF30XA1	DAF30-4		AC164322	AC164322	AC164322	DM300018
dsPIC30F2012	28SO				PMF30XA1	DAF30-4	XLT28SO	AC30F004	AC164302	AC164302	DM300017
dsPIC30F2012	28SP				PMF30XA1	DAF30-4	ACICE0204	AC30F004	AC164301	AC164301	DM300017, DM300018
dsPIC30F2012	28ML				PMF30XA1	DAF30-4	XLT28QFN4	AC164322	AC164322	AC164322	DM300017
dsPIC30F3010	28SO				PMF30XA1	DAF30-4	XLT28SO	AC30F004	AC164302	AC164302	DM300017
dsPIC30F3010	28SP				PMF30XA1	DAF30-4	ACICE0204	AC30F004	AC164301	AC164301	DM300017, DM300018
dsPIC30F3010	44ML				PMF30XA1	DAF30-4	XLT44QFN4	AC164322	AC164322	AC164322	DM300018
dsPIC30F3011	40P				PMF30XA1	DAF30-4	ACICE0206	AC30F003	AC164301	AC164301	DM300018
dsPIC30F3011	44PT				PMF30XA1	DAF30-3	XLT44PT or XLT44PT3	AC30F006	AC164305	AC164305	DM300018
dsPIC30F3011	44ML				PMF30XA1	DAF30-4	XLT44QFN2	AC164322	AC164322	AC164322	DM300018
dsPIC30F3012	18SO				PMF30XA1	DAF30-4	XLT18SO	AC30F005	AC164302	AC164302	DM300018
dsPIC30F3012	18P				PMF30XA1	DAF30-4	ACICE0202	AC30F005	AC164301	AC164301	DM300018
dsPIC30F3012	44ML				PMF30XA1	DAF30-4	XLT44QFN5	AC164322	AC164322	AC164322	DM300018
dsPIC30F3013	28SO				PMF30XA1	DAF30-4	XLT28SO	AC30F004	AC164302	AC164302	DM300017
dsPIC30F3013	28SP				PMF30XA1	DAF30-4	ACICE0204	AC30F004	AC164301	AC164301	DM300017, DM300018
dsPIC30F3013	44ML				PMF30XA1	DAF30-4	XLT44QFN3	AC164322	AC164322	AC164322	DM300018
dsPIC30F3014	40P				PMF30XA1	DAF30-4	ACICE0206	AC30F003	AC164301	AC164301	DM300018
dsPIC30F3014	44PT				PMF30XA1	DAF30-3	XLT44PT or XLT44PT3	AC30F006	AC164305	AC164305	DM300018
dsPIC30F3014	44ML				PMF30XA1	DAF30-4	XLT44QFN2	AC164322	AC164322	AC164322	DM300018
dsPIC30F4011	40P				PMF30XA1	DAF30-4	ACICE0206	AC30F003	AC164301	AC164301	DM300018
dsPIC30F4011	44PT				PMF30XA1	DAF30-3	XLT44PT or XLT44PT3	AC30F006	AC164305	AC164305	DM300018
dsPIC30F4011	44ML				PMF30XA1	DAF30-4	XLT44QFN2	AC164322	AC164322	AC164322	DM300018

**NOTE:** See complete list of notes on page 108.



## Development Systems Products

### MPLAB® ICE 2000 and MPLAB® ICE 4000 Emulator Systems, PRO MATE® II Programmer Socket Modules, MPLAB® In-Circuit Debugger, Software Tools, Programmers and Demonstration Boards (continued)

		MPLAB® ICE 2000 System <sup>(1)</sup>				MPLAB® ICE 4000 System <sup>(2)</sup>							
Part Number	Lead Count/ Pkg Type	Processor Module	Device Adapters	Transition Socket	Processor Module	Device Adapters	Transition Socket	PRO MATE® II Socket Module <sup>(3,4)</sup>	MPLAB® PM3 Socket Module <sup>(6)</sup>	PICSTART® Plus <sup>(5)</sup>	MPLAB® ICD 2 <sup>(6)</sup>	MPLAB® CXX Compiler	Demonstration Boards or Evaluation Kits
<b>dsPIC® DSC Development Tools (continued)</b>													
dsPIC30F4012	28SO				PMF30XA1	DAF30-4	XLT28SO	AC30F004	AC164302		✓	SW006012	DM300017
dsPIC30F4012	28SP				PMF30XA1	DAF30-4	AC/ICE0204	AC30F004	AC164301		✓	SW006012	DM300017, DM300018
dsPIC30F4012	44ML				PMF30XA1	DAF30-4	XLT44QFN4		AC164322		✓	SW006012	
dsPIC30F4013	40P				PMF30XA1	DAF30-4	AC/ICE0206	AC30F003	AC164301		✓	SW006012	DM300018
dsPIC30F4013	44PT				PMF30XA1	DAF30-3	XLT44PT or XLT44PT3	AC30F006	AC164305		✓	SW006012	
dsPIC30F4013	44ML				PMF30XA1	DAF30-4	XLT44QFN2		AC164322		✓	SW006012	
dsPIC30F5011	64PT				PMF30XA1	DAF30-2	XLT64PT2 or XLT64PT5	AC30F008	AC164319		✓	SW006012	
dsPIC30F5013	80PT				PMF30XA1	DAF30-2	XLT80PT or XLT80PT3	AC30F007	AC164320		✓	SW006012	DM300014, DM30004-1, DM30004-2
dsPIC30F5015	64PT				PMF30XA1	DAF30-2	XLT64PT2 or XLT64PT5	AC30F008	AC164319		✓	SW006012	
dsPIC30F5016	80PT					TBD	TBD	AC30F007	AC164320		✓	SW006012	
dsPIC30F6010	80PF				PMF30XA1	DAF30-2	XLT80PT2	AC30F001	AC164314		✓	SW006012	DM300020
dsPIC30F6010A	80PF				PMF30XA1	DAF30-2	XLT80PT2	AC30F001	AC164314		✓	SW006012	DM300020
dsPIC30F6010A	80PT				PMF30XA1	DAF30-2	XLT80PT or XLT80PT3	AC30F007	AC164320		✓	SW006012	DM300020, DM300019, MA300015**
dsPIC30F6011	64PF				PMF30XA1	DAF30-2	XLT64PT3 or XLT64PT4	AC30F002	AC164313		✓	SW006012	
dsPIC30F6011A	64PF				PMF30XA1	DAF30-2	XLT64PT3 or XLT64PT4	AC30F002	AC164313		✓	SW006012	
dsPIC30F6011A	64PT				PMF30XA1	DAF30-2	XLT64PT2 or XLT64PT5	AC30F008	AC164319		✓	SW006012	
dsPIC30F6012	64PF				PMF30XA1	DAF30-2	XLT64PT3 or XLT64PT4	AC30F002	AC164313		✓	SW006012	
dsPIC30F6012A	64PF				PMF30XA1	DAF30-2	XLT64PT3 or XLT64PT4	AC30F002	AC164313		✓	SW006012	
dsPIC30F6012A	64PT				PMF30XA1	DAF30-2	XLT64PT2 or XLT64PT5	AC30F008	AC164319		✓	SW006012	
dsPIC30F6013	80PF				PMF30XA1	DAF30-2	XLT80PT2	AC30F001	AC164314		✓	SW006012	DM300014
dsPIC30F6013A	80PF				PMF30XA1	DAF30-2	XLT80PT2	AC30F001	AC164314		✓	SW006012	
dsPIC30F6013A	80PT				PMF30XA1	DAF30-2	XLT80PT or XLT80PT3	AC30F007	AC164320		✓	SW006012	DM300014

**NOTE:** See complete list of notes on page 108.

**MPLAB® ICE 2000 and MPLAB® ICE 4000 Emulator Systems, PRO MATE® II Programmer Socket Modules, MPLAB® In-Circuit Debugger, Software Tools, Programmers and Demonstration Boards (continued)**

Part Number	Lead Count/ Pkg Type	MPLAB® ICE 2000 System <sup>(1)</sup>			MPLAB® ICE 4000 System <sup>(2)</sup>			PICSTART® Plus <sup>(5)</sup>	MPLAB® ICD 2 <sup>(6)</sup>	MPLAB® CXX Compiler	Demonstration Boards or Evaluation Kits
		Processor Module	Device Adapters	Transition Socket	Processor Module	Device Adapters	Transition Socket				
<b>dsPIC® DSC Development Tools (continued)</b>											
dsPIC30F6014	80PF				PMF30XA1	DAF30-2	XLT80PT2	AC30F001	AC164314	SW006012	DM300014, DM300004-1, DM300004-2
dsPIC30F6014A	80PF				PMF30XA1	DAF30-2	XLT80PT2	AC30F001	AC164314	SW006012	DM300019, MA300014
dsPIC30F6014A	80PT				PMF30XA1	DAF30-2	XLT80PT or XLT80PT3	AC30F007	AC164320	SW006012	DM300014, DM300004-1, DM300004-2
dsPIC30F6015	64PT							AC30F008	AC164319	SW006012	
dsPIC33FJ64GP206	64PT								TBD	SW006012*	DM240001, DM300019
dsPIC33FJ64GP306	64PT								TBD	SW006012*	DM240001, DM300019
dsPIC33FJ64GP310	100PT								TBD	SW006012*	DM240001, DM300019
dsPIC33FJ64GP706	64PT								TBD	SW006012*	DM240001, DM300019
dsPIC33FJ64GP708	80PT								TBD	SW006012*	DM240001, DM300019
dsPIC33FJ64GP710	100PT								TBD	SW006012*	DM240001, DM300019
dsPIC33FJ128GP206	64PT								TBD	SW006012*	DM240001, DM300019
dsPIC33FJ128GP306	64PT								TBD	SW006012*	DM240001, DM300019
dsPIC33FJ128GP310	100PT								TBD	SW006012*	DM240001, DM300019
dsPIC33FJ128GP706	64PT								TBD	SW006012*	DM240001, DM300019
dsPIC33FJ128GP708	80PT								TBD	SW006012*	DM240001, DM300019
dsPIC33FJ128GP710	100PT								TBD	SW006012*	DM240001, DM300019
dsPIC33FJ256GP506	64PT								TBD	SW006012*	DM240001, DM300019
dsPIC33FJ256GP510	100PT								TBD	SW006012*	DM240001, DM300019
dsPIC33FJ256GP710	100PT								TBD	SW006012*	DM240001, DM300019

NOTE: See complete list of notes on page 108.

**MPLAB® ICE 2000 and MPLAB® ICE 4000 Emulator Systems, PRO MATE® II Programmer Socket Modules, MPLAB® In-Circuit Debugger, Software Tools, Programmers and Demonstration Boards (continued)**

Part Number	MPLAB® ICE 2000 System <sup>(1)</sup>				MPLAB® ICE 4000 System <sup>(2)</sup>				PICSTART® Plus <sup>(5)</sup>	MPLAB® ICD 2 <sup>(6)</sup>	MPLAB® CXX Compiler	Demonstration Boards or Evaluation Kits
	Lead Count/ Pkg Type	Processor Module	Device Adapters	Transition Socket	Processor Module	Device Adapters	Transition Socket	PRO MATE® II Socket Module <sup>(3,4)</sup>				
<b>dsPIC® DSC Development Tools (continued)</b>												
dsPIC33FJ64MC506	64PT										SW006012*	
dsPIC33FJ64MC508	80PT										SW006012*	
dsPIC33FJ64MC510	100PT										SW006012*	
dsPIC33FJ64MC706	64PT										SW006012*	
dsPIC33FJ64MC710	100PT										SW006012*	
dsPIC33FJ28MC506	64PT										SW006012*	
dsPIC33FJ28MC510	100PT										SW006012*	
dsPIC33FJ28MC706	64PT										SW006012*	
dsPIC33FJ28MC708	80PT										SW006012*	
dsPIC33FJ28MC710	100PT										SW006012*	
dsPIC33FJ256MC510	100PT										SW006012*	
dsPIC33FJ256MC710	100PT										SW006012*	

**NOTE:** See complete list of notes on page 108.

**NOTES - MPLAB® ICE 2000 and MPLAB® ICE 4000 Emulator Systems, PRO MATE® II Programmer Socket Modules, MPLAB® In-Circuit Debugger, Software Tools, Programmers and Demonstration Boards**

- 1:** MPLAB® ICE 2000 pod available separately. (ICE2000)
  - 2:** MPLAB® ICE 4000 pod available separately. (ICE4000)
  - 3:** PRO MATE® II Programmer unit (no longer available). (DV007003)
  - 4:** Optional In-Circuit Serial Programming™ (ICSP™) Socket for PRO MATE® II available separately. (AC004004)
  - 5:** PICSTART® Plus (DV003001)
  - 6:** MPLAB® ICD 2 In-Circuit Debugger. Configurations are:  
(DV164005) ICD 2 module, USB cable and ICD cable.  
(DV164006) ICD 2 module, USB cable, serial cable, PICDEM™ 2 Plus and power supply.  
(DV164007) ICD 2 module, USB cable, ICD cable, serial cable and power supply.  
(DV164030) ICD 2 module, USB cable, ICD cable, serial cable and dsPICDEM™ Starter Demo Board;  
(AC162049) ICD 2 Universal Programming Module;  
(AC162051) ICD or ICD 2 28/40 PDIP Header Interface Board.  
**7:** Custom adapter required; not available from Microchip. See "Readme" for PICSTART® Plus.
  - 8:** MPLAB® PM3 Programmer Unit available separately. (DV007004). ICSP™ function is built-in with MPLAB® PM3 Programmer.  
(AC164350) MPLAB® PM3 Adapter for PRO MATE® II Socket modules.
  - 9:** Supported natively by ICD 2, but ICD 2 header gives user access to I/O pins RB6 and RB7.
- \* Future support. Contact Microchip web site at [www.microchip.com](http://www.microchip.com) for availability.  
 \*\* New/Future product. Contact Microchip web site at [www.microchip.com](http://www.microchip.com) for availability.  
 ✓ Supported with basic configuration. If a part number is listed in the column, that part is required and available separately.

## Demonstration Boards and Evaluation Kits

Part Number	Description
<b>PICmicro® Demonstration Kits</b>	
DM163014	PICDEM™ 4 Demo Board for PIC12F629, 675, PIC16F630, 676, 684, 627A, 628A, 648A, 818, 819, 87, 88, PIC18F1220, 1320
DM163022	PICDEM™ 2 Plus Demo Board for PIC16C62, 63, 64, 65, 66, 67, 72, 73, 74, 76, 77, 87X, 773, 774 and PIC18CXX2, 642, 662, and PIC18FXXX
DM163026	Low-Power Solutions Demo Board
DM163028	PICDEM™ LCD Demo Board (uses 64L/80L PIC18FXX90 and 28L/40L PIC16F91X family)
DM163029	PICDEM™ Mechatronics Demo Board
DM164120-1	PICkit™ 2 Low Pin Count Demo Board
DV164101	PICkit™ 1 8/14P Flash Development Kit for PIC12F629, 675 and PIC16F630, 676
DV164102	rPIC® Development Kit 1
DV164120	PICkit™ 2 Starter Kit
PG164120	PICkit™ 2 Microcontroller Programmer
AC164101	rPIC® Transmitter Module (433.92 MHz)
AC164102	rPIC® Transmitter Module (315 MHz)
AC164103	rRXD Receiver Module (433.92 MHz)
AC164104	rRXD Receiver Module (315 MHz)
AC164120	Signal Analysis PICtail™ Daughter Board
AC164121	Ethernet PICtail™ Daughter Board
AC164122	PICtail™ Daughter Board for SD and MMC Cards
AC164123**	Ethernet PICtail™ Plus Daughter Board
AC164124**	IrDA® PICtail™ Plus Daughter Board
AC163020	PIC10F2XX Programmer Adapter
AC163021	6L SOT-23 to 8P DIP Adapter Kit
DM183011	PICDEM™ MC Development Board (uses 28L/40L PIC18FXX31 family)
DM183021	PICDEM™ MC LV Development Board (uses 28L PIC18F2331, 2431, dsPIC30F family)
DM183022	PICDEM™ HPC Explorer Board
DM240001	Explorer 16 Demo Board
<b>Connectivity Demonstration Kits</b>	
DM163004-LT	PICDEM.net™ TCP/IP Demo Board (with no text book)
DM163005	PICDEM™ LIN Demo Board for PIC16C432/433 LIN bus
DM163007	PICDEM™ CAN-LIN 1 Demo Board (uses 68L/84L PIC18CXX8 family)
DM163010	PICDEM™ USB Demo Board for PIC16C7X5
DM163011	PICDEM™ CAN-LIN 2 Demo Board (uses 28L/40L PIC18FXX8 and PIC18FXX8X family)
DM163015	PICDEM™ CAN-LIN 3 Demo Board (uses 64L/80L PIC18FXX8X family)
DM163025	PICDEM™ FS USB Demo Board
DM163027-2	PICDEM™ Z 2.4 GHz Demonstration Kit

**NOTE:** See complete list of notes on page 108.

**Demonstration Boards and Evaluation Kits (continued)**

Part Number	Description
<b>Connectivity Demonstration Kits (continued)</b>	
AC163027-1	PICDEM™ Z Motherboard
AC163027-2	PICDEM™ Z 2.4 GHz RF Card
<b>Mixed Signal Control Demonstration Kits</b>	
AC163001	PICDEM™ MSC 1 Voltage Boost Demo Board; requires DM163012
AC163002	PICDEM™ MSC 1 High Power IR Demo Board; requires DM163012
AC163003	PICDEM™ MSC 1 Delta Sigma Demo Board; requires DM163012
AC163004	PICDEM™ MSC 1 Flow Rate Sensor Demo Board; requires DM163012
DM163012	PICDEM™ MSC 1 Mixed Signal Controller Demo Board for PIC16C781/782
<b>dsPIC® DSC Demonstration Kits</b>	
DM183021	PICDEM™ MC LV Development Board (uses 28L PIC18F2331/2431, dsPIC30F family)
DM240001	Explorer 16 Demo Board
DM3000004-1	dsPICDEM.net™ 1 FCC/JATE PSTN Support, Ethernet NIC Development Board
DM3000004-2	dsPICDEM.net™ 2 CTR-21 PSTN Support, Ethernet NIC Development Board
DM3000014	dsPICDEM™ 1.1 General Purpose Development Board
DM3000017	dsPICDEM™ 28-Pin Starter Development Board
DM3000018	dsPICDEM™ 2 Development Board
DM3000019	dsPICDEM 80-Pin Starter Development Board
DM3000020	dsPICDEM™ MC1 Motor Control Development Board
DM3000021	dsPICDEM™ MC1H 3-Phase High Voltage Power Module
DM3000022	dsPICDEM™ MC1L 3-Phase Low Voltage Power Module
<b>dsPIC® 16-Bit DSC Software Tools</b>	
SW3000001	Digital Filter Design
SW3000002	dsPIC® V.22/N.22bis Soft Modem Library (free download: <a href="http://www.microchip.com">www.microchip.com</a> )
SW3000003-EVAL	dsPIC® V.32 Soft Modem Library (Eval Copy)
SW3000003, 04, 05	dsPIC® V.32 Soft Modem Library (5K, 25K, 100K licenses, respectively)
SW3000006	dsPIC® V.22/N.22bis Soft Modem Library by Vocal Technology
SW300010-EVAL	dsPIC® Speech Recognition (Eval Copy)
SW300010, 11, 12	dsPIC® Speech Recognition (5K, 25K, 100K licenses, respectively)
SW3000020	dsPIC30 Math Library: Double-Precision Floating Point Routines
SW3000021	dsPIC30 Peripheral Library: Peripheral Initialization and Control Routines
SW3000022	dsPIC30 DSP Library: Data Signal Processing Library Suite (FFT, Filters)
SW3000023	dsPICworks™ Visual Algorithm Analyzer: Data Analyzer and Converter Tool
SW3000030	dsPIC® CMX Scheduler: Multi-tasking, Preemptive Scheduler for dsPIC30F
SW3000031	CMX-RTX for dsPIC® DSC: Fully Preemptive RTOS

**NOTE:** See complete list of notes on page 108.



## Demonstration Boards and Evaluation Kits (continued)

Part Number	Description
<b>dsPIC® 16-Bit DSC Software Tools (continued)</b>	
SW300032	CMX-Tiny+ for dsPIC® DSC: Preemptive RTOS
SW300040-EVAL, 5K, 25K, 100K	dsPIC® Noise Suppression Library (Eval, 5K, 25K, 100K licenses, respectively)
SW300050-EVAL, 5K, 25K, 100K	dsPIC® Symmetric Embedded Encryption Library (Eval, 5K, 25K, 100K licenses, respectively)
SW300055-EVAL, 5K, 25K, 100K	dsPIC® Asymmetric Embedded Encryption Library (Eval, 5K, 25K, 100K licenses, respectively)
SW300060-EVAL, 5K, 25K, 100K	dsPIC® Acoustic Echo Cancellation Library (Eval, 5K, 25K, 100K licenses, respectively)
SW300070-EVAL, 5K, 25K, 100K	dsPIC® Speech Coding/Decoding Library (Eval, 5K, 25K, 100K licenses, respectively)
SW300080-EVAL, 5K, 25K, 100K	dsPIC® Line Echo Cancellation Library (Eval, 5K, 25K, 100K licenses, respectively)

**NOTE:** See complete list of notes on page 108.

## Memory Evaluation/Developer's Kits

SEEVAL® 32 Serial EEPROM Developer's Kit	DV243002	All serial EEPROMS, 24XX, 93XX, 25XX series
--	----------	---

## KEELOQ® Evaluation Kits

	HCS101	HCS200/201	HCS300/301/320	HCS360/361	HCS362	HCS365/370	HCS410/412	HCS500/515	HCS512
KEELOQ® Evaluation Kit II*	DM303006	DM303006	DM303006	DM303006	DM303006	DM303006	DM303006	DM303006	
PRO MATE® II Universal Programmer for SOIC*	AC004002	AC004002	AC004002	AC004002	AC004002	AC004003	AC004002	–	AC164002
PRO MATE® II Universal Programmer for DIP*	AC004001	AC004001	AC004001	AC004001	AC004001	AC004007	AC004001	–	AC164001
PRO MATE® II Universal Programmer for ICSP™*	AC004004	AC004004	AC004004	AC004004	AC004004	AC004004	AC004004	AC004004	

\* Support is limited to PRO MATE® II using MPLAB® IDE release 5.70.

## RFID Evaluation/Developer's Kits

13.56 MHz Anti-Collision microID® Developer's Kits	MCRF355	MCRF450/452
microID® Programmer Kit only for MCRF355	DV103003, DV103006	DV103006
	PG103003	–

## Analog/Interface Demo/Eval/Developer's Kits

Interface	Part Number	Devices Supported
MCP2140 IrDA® Wireless Temp. Demo	MCP2140DM-TMPSNS	MCP2140
MCP215X Data Logger Demo Board	MCP215XDM	MCP2150/55
MCP250XX CAN I/O Expanders Developer's Kit	DV250501	MCP25020, MCP25025, MCP25050, MCP25055
MCP2510/2515 CAN Developer's Kit	DV251001	MCP2510, MCP2515
MCP2120/2150 Developer's Kit	DM163008	MCP2120, MCP2150
MCP23X08 Evaluation Board	MCP23X08EV	MCP23008, MCP23S08
MCP23X17 Evaluation Board	MCP23X17EV	MCP23017, MCP23S17

Analog/Interface Demo/Eval/Developer's Kits (continued)

Linear	Part Number	Devices Supported
MCP6S22 PGA PICtail™ Demo Board	MCP6S22DM-PIC1L	MCP6S22/92
MCP6SX2 PGA Photodiode PICtail™ Demo Board	MCP6SX2DM-PCTLPD	MCP6S22/92
MCP6SX2 PGA Thermistor PICtail™ Demo Board	MCP6SX2DM-PCTLTH	MCP6S22/92
MCP6S2X PGA Evaluation Board	MCP6S2XEV	MCP6S2X
<b>Mixed Signal</b>	<b>Part Number</b>	<b>Devices Supported</b>
Mixed Signal PICtail™ Demo Board	MXSIGDM	TX132X, MCP330X, MCP320X, MCP494X, MCP3221, MCP3201, MCP1525, MCP1541
Evaluation Kit for Sigma-Delta A/D Converter Family	TX3400EV	TX3400X
Single-Dual A/D	DV3201A	MCP3001, MCP3002, MCP3201, MCP3202
MCP3201/02 Evaluation System Daughter Board	DV3201A	MCP3201/02
MXDEV Analog Evaluation System	DVMCPA	MCP3001/02, MCP3004/08, MCP3201/02, MCP3204/08
MCP3204/08 Evaluation System Daughter Board	DV3204A	MCP3204, MCP3208
MCP42XXX Digital Pot Evaluation Kit	DV42XXX	MCP42010, MCP42050, MCP42100
MCP402X Evaluation Board	MCP402XEV	MCP4021, MCP4022, MCP4023, MCP4024
<b>Power Management</b>	<b>Part Number</b>	<b>Devices Supported</b>
MCP1612 Synchronous Buck Regulator Evaluation Board	MCP1612EV	MCP1612
MCP1630 +12V Dual Output Buck Converter Ref. Design	MCP1630RD-DDBK1	MCP1630
MCP1630 Li-Ion Multi Bay Battery Charger Ref. Design	MCP1630RD-LIC1	MCP1630
MCP1630 NiMH Battery Charger Demo Board	MCP1630DM-NMC1	MCP1630
MCP1601 Buck Regulator Evaluation Board	MCP1601EV	MCP1601
Voltage Supervisor Evaluation Board	VSUPEV	SOT-23 packages
MCP7386X Li-Ion Battery Charger Evaluation Board	MCP7386XEV	MCP73861/62
MCP165X 3W White LED Demo Board	MCP1650DM-LED1	MCP1650/51
MCP1650 Boost Controller Evaluation Board	MCP1650EV	MCP1650
MCP7384X Li-Ion Battery Charger	MCP7384XEV	MCP7384X
MCP7382X Li-Ion Battery Charger	MCP7382XEV	MCP7382X
MCP73855 Evaluation Board	MCP73855EV	MCP73855
Voltage Supervisor SOT23-5/6 Evaluation Board	VSUPEV2	SOT23-5/6-lead packages
MCP1726 Evaluation Board	MCP1726EV	MCP1726
<b>Thermal Management Tools</b>	<b>Part Number</b>	<b>Devices Supported</b>
MCP9800 Thermal Sensor PICtail™ Demo Board	MCP9800DM-PCTL	MCP9800
Demo Board for Tiny Serial Digital Thermal Sensor	TC74DEMO	TC74
Fan Controller Demo Board for TC652	TC652DEMO	TC652
Fan Controller Demo Board for TC650	TC650DEMO	TC650
Evaluation Kit for the Fan Speed Controllers	TC642EV	TC642, TC646, TC647, TC648, TC649, TC642B, TC646B, TC647B, TC648B, TC649B
TC72 Digital Temperature Sensor	TC72DM-PIC1L	TC72
TC77 Thermal Sensor PICtail™ Demo	TC77DM-PIC1L	TC77
Demo Board for Fan Speed Controllers	TC642DEMO	TC642
TC1047A Temperature to Voltage	TC1047ADM-PIC1L	TC1047A

# PIN AND CODE COMPATIBILITY CHART

## 8-Pin PICmicro® MCU Family

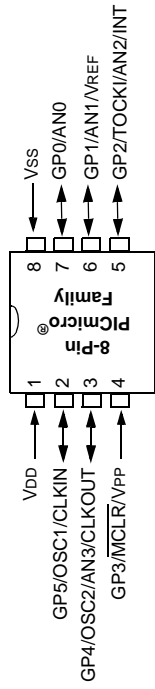

PIC12C508A	PIC12C671	PIC12F510
PIC12C509A	PIC12C672	PIC12F629
PIC12CR509A	PIC12CE673	PIC12F635
PIC12CE518	PIC12CE674	PIC12F675
PIC12CE519	PIC12F508	PIC12F683
	PIC12F509	

## 8-Pin KeeLoq® Family

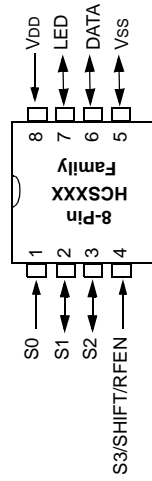

HCS101	HCS300	HCS360
HCS200	HCS301	HCS361
HCS201	HCS320	HCS362
		HCS365

## 8/14/20-Pin PICmicro® MCU Family

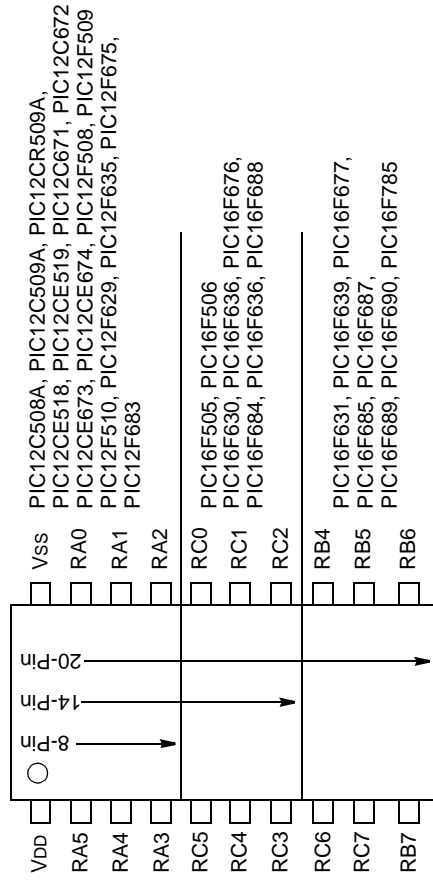

## 14-Pin PICmicro® MCU Family

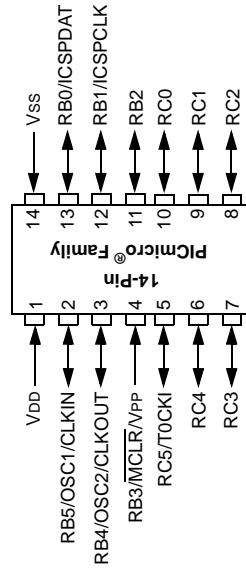

PIC16F505	PIC16F630	PIC16F688
PIC16F506	PIC16F636	PIC16F684
	PIC16F676	

### 18-Pin PICmicro® MCU Family

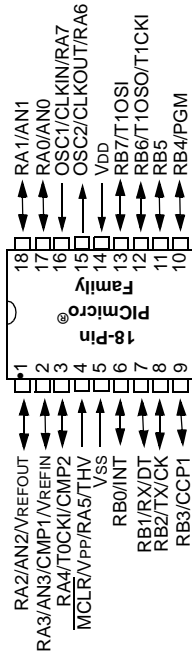

PIC16C620A	PIC16CE625	PIC16C711	PIC16F819
PIC16CR620A	PIC16F627	PIC16C712	PIC16F87
PIC16C621A	PIC16F628	PIC16C715	PIC16F88
PIC16C622A	PIC16F627A	PIC16C716	PIC16F54
PIC16CE623	PIC16F628A	PIC16F716	PIC16HV540
PIC16CE624	PIC16F648A	PIC16C58B	PIC18F1220
PIC16C54C	PIC16C56A	PIC16F84A	PIC18F1320
	PIC16C710	PIC16F818	

### 20-Pin PICmicro® MCU Family

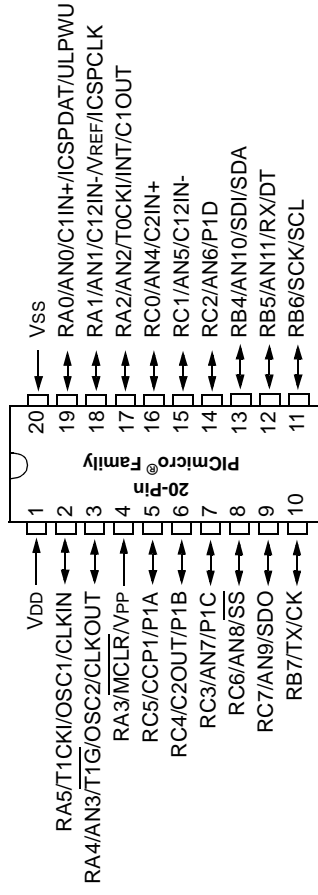

PIC16F685	PIC16F689
PIC16F687	PIC16F690

### 28-Pin PICmicro® MCU Family

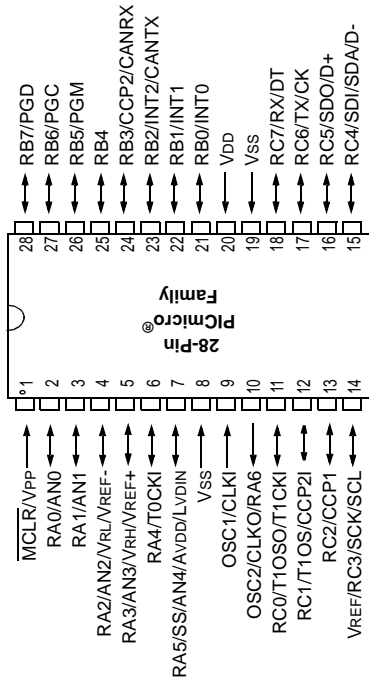

PIC16C62B	PIC16F767*	PIC18F2331
PIC16CR63	PIC16F870*	PIC18F2410
PIC16C63A	PIC16F872*	PIC18F2420
PIC16C642	PIC16F873*	PIC18F2431
PIC16C66	PIC16F873A*	PIC18F2455
PIC16CR72	PIC16F876*	PIC18F2480
PIC16C72A	PIC16F876A*	PIC18F2510
PIC16C73B	PIC16F913*	PIC18F2515
PIC16C745	PIC18C242	PIC18F2520
PIC16C76	PIC18C252	PIC18F2525
PIC16C773	PIC18F242	PIC18F2550
PIC16F57	PIC18F248	PIC18F2580
PIC16F72*	PIC18F252	PIC18F2585
PIC16F73*	PIC18F258	PIC18F2610
PIC16F737*	PIC18F2220	PIC18F2620
PIC16F76*	PIC18F2221	PIC18F2680
	PIC18F2320	
	PIC18F2321	

\* PGM for PIC16FXXX devices is located on pin 24.

### 40-Pin PICmicro® MCU Family

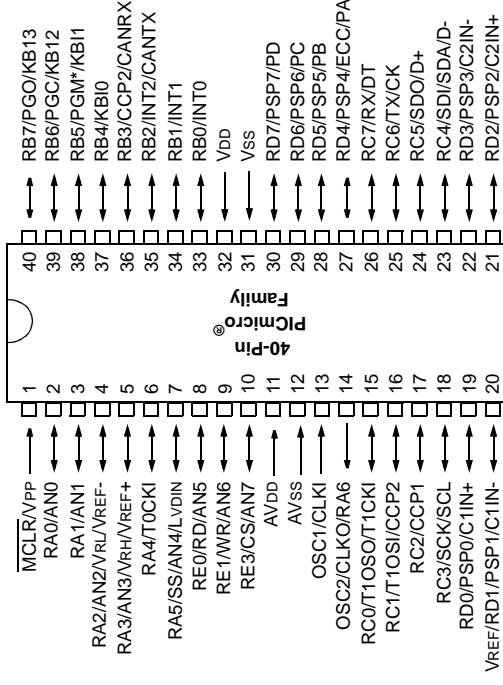

PIC16CR65	PIC16F874A*	PIC18F4331
PIC16C65B	PIC16F877*	PIC18F4410
PIC16C662	PIC16F877A*	PIC18F4420
PIC16C67	PIC16F914*	PIC18F4431
PIC16C74B	PIC16F917*	PIC18F4455
PIC16C765	PIC18C442	PIC18F4480
PIC16C77	PIC18C452	PIC18F4510
PIC16C774	PIC18F442	PIC18F4515
PIC16F59	PIC18F448	PIC18F4520
PIC16F74*	PIC18F452	PIC18F4525
PIC16F747*	PIC18F458	PIC18F4550
PIC16F77*	PIC18F4220	PIC18F4580
PIC16F777*	PIC18F4221	PIC18F4585
PIC16F871*	PIC18F4320	PIC18F4610
PIC16F874*	PIC18F4321	PIC18F4620
	PIC18F4680	

\* PGM for PIC16FXXX devices is located on pin 36.

### 64-Pin PICmicro® MCU Family

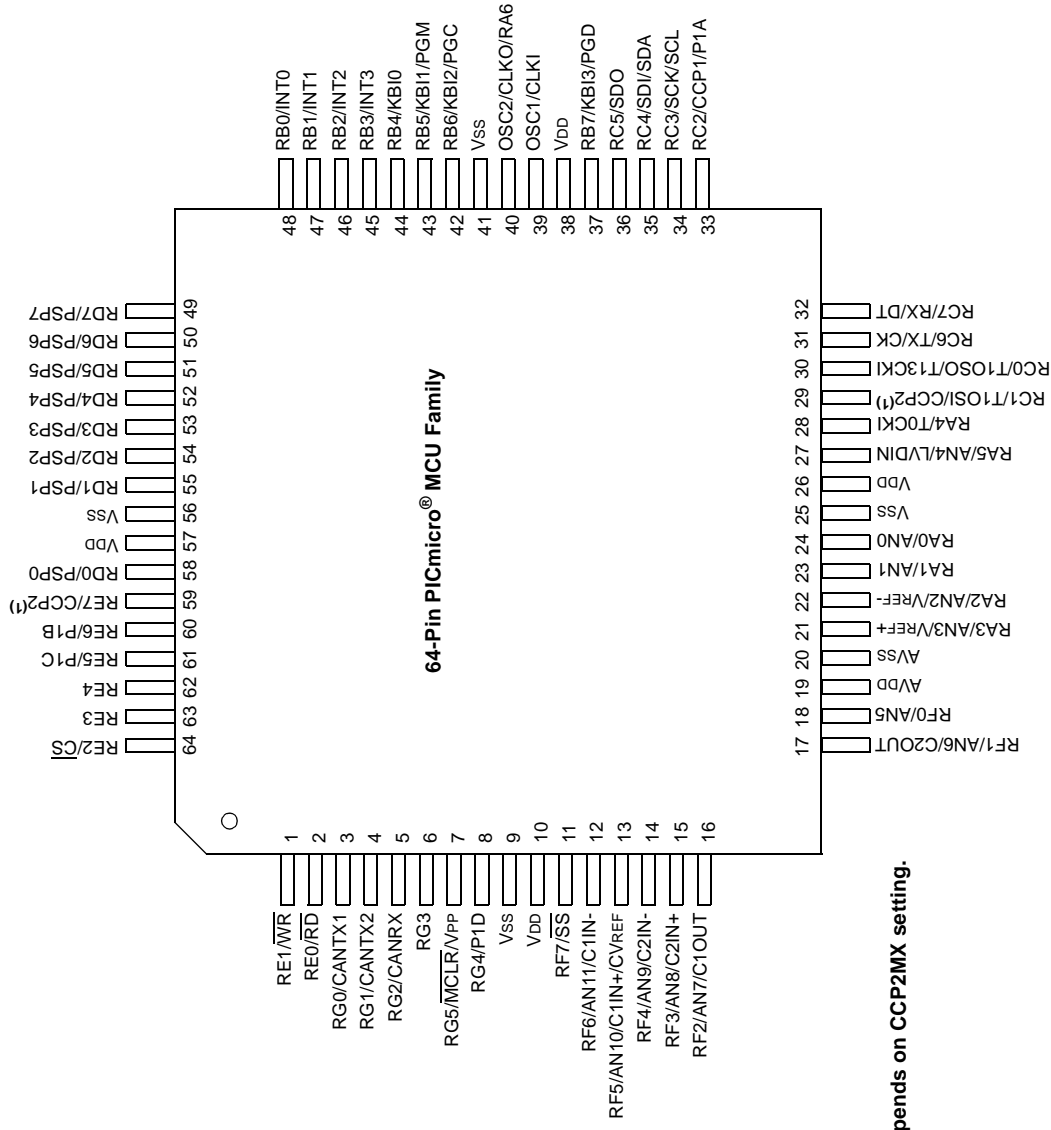

**Note 1:** CCP2 pin placement depends on CCP2MX setting.

PIC18F6310	PIC18F6522	PIC18F6621
PIC18F6390	PIC18F6525	PIC18F6627
PIC18F6410	PIC18F6527	PIC18F6680
PIC18F6490	PIC18F6585	PIC18F6720
PIC18F6520	PIC18F6620	PIC18F6722
	PIC18F6622	



**Microchip Packaging**



18-LEAD CERDIP  
"JW"



20-LEAD CERDIP  
"JW"



28-LEAD CERDIP  
"JW"

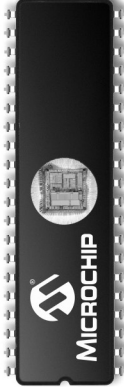

40-LEAD CERDIP  
"JW"



8-LEAD PDIP  
"p" OR "PA"



14-LEAD PDIP  
"p" OR "PD"



18-LEAD PDIP  
"p"



20-LEAD PDIP  
"p"



24-LEAD PDIP  
"p" OR "PG"



28-LEAD PDIP  
"p" OR "PI"



28-LEAD SKINNY PDIP  
"SP" OR "PJ"



40-LEAD PDIP  
"p" OR "PL"



32-LEAD PLCC  
"L"



44-LEAD PLCC  
"L" OR "W"



68-LEAD PLCC  
"L" OR "LS"

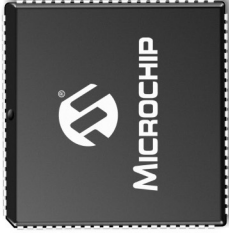

84-LEAD PLCC  
"L"

**CERAMIC CHIP CARRIER  
CERQUAD**

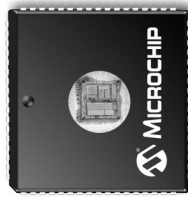

68-LEAD CERQUAD  
"CL"



84-LEAD CERQUAD  
"CL"

**PLASTIC QUAD  
FLATPACK  
"QFP"**



32-LEAD LQFP  
"LQ"



44-LEAD MQFP  
"PQ"

PACKAGES ARE APPROXIMATE SIZE



PLASTIC SMALL OUTLINE "SOIC"



8-LEAD SOIC  
(.150") "SN" or "OA"



16-LEAD SOIC  
(.150") "SL"



8-LEAD SOIC  
(.208") "SM"



18-LEAD SOIC  
"SO"



14-LEAD SOIC  
(.150") "SL" or "OD"



20-LEAD SOIC  
"SO"



28-LEAD SOIC  
"SO" or "OI"

PLASTIC SHRINK  
SMALL OUTLINE "SSOP"



20-LEAD SSOP  
"SS"



28-LEAD SSOP  
"SS"



16-LEAD QSOP



8-LEAD MSOP  
"MS" or "UA"



10-LEAD MSOP  
"UN"

PLASTIC THIN QUAD  
FLATPACK "TQFP"



44-LEAD TQFP  
"PT"



64-LEAD TQFP  
"PT"



64-LEAD TQFP  
"PF"



80-LEAD TQFP  
"PT"  
(12x12)



80-LEAD TQFP  
"PF"  
(14x14)



100-LEAD TQFP  
"PT"  
(12x12)



100-LEAD TQFP  
"PF"  
(14x14)

SIDE BRAZED  
DUAL IN-LINE "DIP"



8-LEAD SIDE BRAZED  
"JW"



14-LEAD SIDE BRAZED  
"JW"



20-LEAD SIDE BRAZED  
"JW"



28-LEAD SIDE BRAZED  
(.300") "JW"

PACKAGES ARE APPROXIMATE SIZE

PLASTIC THIN SHRINK  
SMALL OUTLINE

 8-LEAD TSSOP  
(4.4 MM) "ST"

 14-LEAD TSSOP  
(4.4 MM) "ST" (PICmicro® MCU)  
(4.4 MM) "ST14" (Memory)

 20-LEAD TSSOP  
(4.4 MM) "ST"

CHIP SCALE PACKAGES

 8-LEAD DFN  
2x3 "MC"

 8-LEAD DFN  
3x3 "MF"

 8-LEAD DFN  
6x5 "MF"

 28-LEAD QFN  
6x6 "ML" or "MM"

 8-LEAD DFN  
4x4 "MD"

 16-LEAD QFN  
4x4 "ML"

 20-LEAD QFN  
4x4 "ML"

 44-LEAD QFN  
8x8 "ML"

SMALL OUTLINE TRANSISTORS

 3-LEAD TRANSISTOR  
"TO" or "ZB"

 3-LEAD SC-89

 SOT-223

 6-LEAD SOT-23  
"CH" or "OT"

 3-LEAD SOT-23  
"TT" or "CB"

 SOT-143  
"RC"

 5-LEAD SOT-23  
"OT" or "CT"

 5-LEAD SC-70  
"LT"

 3-LEAD SC-70  
"LB"

 3-LEAD DPAK

 5-LEAD DPAK

 5-LEAD TO-220

PACKAGES ARE APPROXIMATE SIZE

# Part Number Suffix Designations

Ordering Information for all Microchip PICmicro®, dsPIC®, KEELoq®, RFID, rfHCS and Memory Products

XXXXXXXXXX - XX X/XX XXX

QTP, SQTP or ROM Code; Special Requirements

**Package:**

CB = Chip on Board (COB)	S = Die in Waffle Pack
CL = Windowed CERQUAD	SL = 14-lead Small Outline (150 mil)
G = Lead Free	SM = 8-lead Small Outline (207 mil)
JW = Windowed CERDIP	SN = 8-lead Small Outline (150 mil)
L = Plastic Leaded Chip Carrier (PLCC)	SO = Plastic Small Outline (SOIC) (300 mil)
LQ = Plastic Low Quad Flatpack (LQFP)	SP = Plastic Skinny DIP
MC = Dual Flat-No Leads (DFN) 2x3 mm	SS = Plastic Shrink Small Outline (SSOP)
MF = Dual Flat-No Leads (DFN) 5x6 mm	ST = Thin Shrink Small Outline (TSSOP) 4.4 mm
ML = Quad Flat-No Leads (QFN) 6x6 mm, 8x8 mm	ST14 = 14-lead Thin Shrink Small Outline (TSSOP-14)
MM = Quad Flat-No Leads (QFN) 6x6 mm	TO-92 = Transistor Outline
MS = Micro Small Outline (MSOP)	TS = Thin Small Outline (8 mm x 20 mm)
OT = 5-Lead or 6-Lead SOT-23	TT = SOT-23-3 Small Outline Transistor
P = Plastic DIP	VS = Very Small Outline (8 mm x 12 mm)
PF = Plastic Thin Quad Flatpack (TQFP) 14x14 mm	W = Uncut Wafer
PQ = Plastic Quad Flatpack (PQFP)	WF = Sawed Wafer on Frame
PT = Plastic Thin Quad Flatpack (TQFP) 10x10 mm, 12x12 mm	WM = SOT385 Leadless Module

**Process Temperature:**

Blank = 0°C to +70°C  
 I (Industrial) = -40°C to +85°C  
 E (Extended) = -40°C to +125°C

**Speed:** OR

-90 = 90 ns
-10 = 100 ns
-12 = 120 ns
-15 = 150 ns
-17 = 170 ns
-20 = 200 ns or 20 MIPS
-25 = 250 ns
-30 = 300 ns or 30 MIPS

**Crystal Frequency Designator for PICmicro® MCUs**

LP = DC to 40 kHz, Low-Power Crystal Oscillator
RC = DC to 4 MHz, Resistor/Capacitor Oscillator
XT = DC to 4 MHz, Standard Crystal Resonator Oscillator
HS = DC to 20 MHz, High-Speed Crystal Oscillator
02 = DC to 2 MHz, XT and RC Oscillator Support
04 = DC to 4 MHz Internal, XT and RC Oscillator Support
04 = DC to 200 kHz, LP Oscillator Support
08 = DC to 8 MHz, HS Oscillator Support
10 = DC to 10 MHz, HS Oscillator Support
16 = DC to 16 MHz, XT Oscillator Support
20 = DC to 20 MHz, HS Oscillator Support
25 = DC to 25 MHz, XT Oscillator Support
30 = DC to 30 MHz, HS Oscillator Support
33 = DC to 33 MHz, XT Oscillator Support
40 = DC to 40 MHz, HS Oscillator Support

**Option:**

T = Tape and Reel Shipments  
 X = Rotated Pinout

**Device Type: (Up to 10 digits)**

AA = 1.8V Serial EEPROM	LCE = Low-Voltage CMOS EPROM/EEPROM MCU
C = CMOS EPROM/ROMless MCU	LCR = Low-Voltage CMOS ROM MCU
C = 5V Serial EEPROM	LCS = Low-Voltage Security
CE = CMOS EPROM/EEPROM MCU	LF = Low-Voltage Flash MCU
CR = CMOS ROM MCU	LV = Low Voltage
F = Flash MCU	R = CMOS ROM MCU (PIC18)
FC = High-Speed Serial EEPROM	24 = 2-Wire (I <sup>2</sup> C™)
HC = High Speed	25 = SPI
HV = High Voltage	93 = 3-Wire (Microwire)
LC = Low-Voltage CMOS EPROM MCU	
LC = Low-Voltage (2.5V) Serial EEPROM	

Product Information System

## Part Number Suffix Designations

Ordering Information for all Microchip Analog Products beginning with "TC" (formerly TelCom Semiconductor Products)

TC 7106 A-60 1 C P L 713

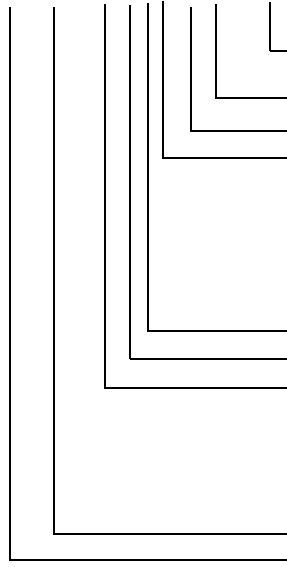

**Taping Direction:**

TR or 713: Standard Taping, blank: no tape and reel

**Number of Package Pins (See specific data sheet)**

**Package Type**

**Operating Temperature Range:**

- C: Commercial Range (0°C to +70°C)
- E: Extended Industrial Range (-40°C to +85°C)
- I: Industrial Range (-25°C to +85°C)
- M: Military Range (-55°C to +125°C)
- V: See Data Sheet for Specific Temperature Range

**(Extra Feature Code and/or Tolerance)\* (See specific data sheet)**

**(Output Voltage or Detect Voltage)\* (If applicable, see specific data sheet)**

**Electrical Performance Grade Option (Variation/Option)\* (If applicable, see specific data sheet)**

- A: Test Selection Criteria (See specific data sheet)
- B:
- R: Reversed Pin Layout

**Product Part Number (2 to 6 characters, see specific data sheet)**

**Product Prefix**

**NOTE:** (\*) Used for voltage regulators and detectors.

Package	Description	# of Pins
AB	TO-220	3
AK	TO-220	7
AT	TO-220	5
AV	TO-220 (Formed)	5
BB	TO-220B	3
CB	SOT-23A	3
CH	SOT-23A	6
CT	SOT-23A	5
DB	SOT-223	3
EB	DDPAK	3
EK	DDPAK	7
ET	DDPAK	5
HA	SOP	8
JA	CDIP (N)	8
JD	CDIP (N)	14
JE	CDIP (N)	16
JG	CDIP (W)	24
JI	CDIP (W)	28
JL	CDIP (W)	40
KU	MQFP	64
KW	MQFP	44
LB	SC-70	3
LI	PLCC	28
LS	PLCC	68
LT	SC-70	5
LW	PLCC	44

Package	Description	# of Pins
MB	SOT-89	3
MF	DFN (3x3)	8
MT	SOT-89	5
NB	SOT-23B	3
OA	SOIC (N)	8
OD	SOIC (N)	14
OE	SOIC (W)	16
OG	SOIC (W)	24
OI	SOIC (W)	28
OR	SOIC (N)	16
PA	PDIP (N)	8
PD	PDIP (N)	14
PE	PDIP (N)	16
PF	PDIP (N)	24
PG	PDIP (W)	24
PI	PDIP (W)	28
PJ	PDIP (W)	28
PL	PDIP (W)	40
QR	QSOP (N)	16
RC	SOT-143	4
SI	SSOP (W)	28
UA	MSOP	8
UN	MSOP	10
VB	DDPAK	3
ZB	TO-92	3
ZM	TO-92	2

# Part Number Suffix Designations

Ordering Information for all Microchip Analog Products beginning with "MCP" Prefix Parts

MCP xxxxx T - yyy z h / qq

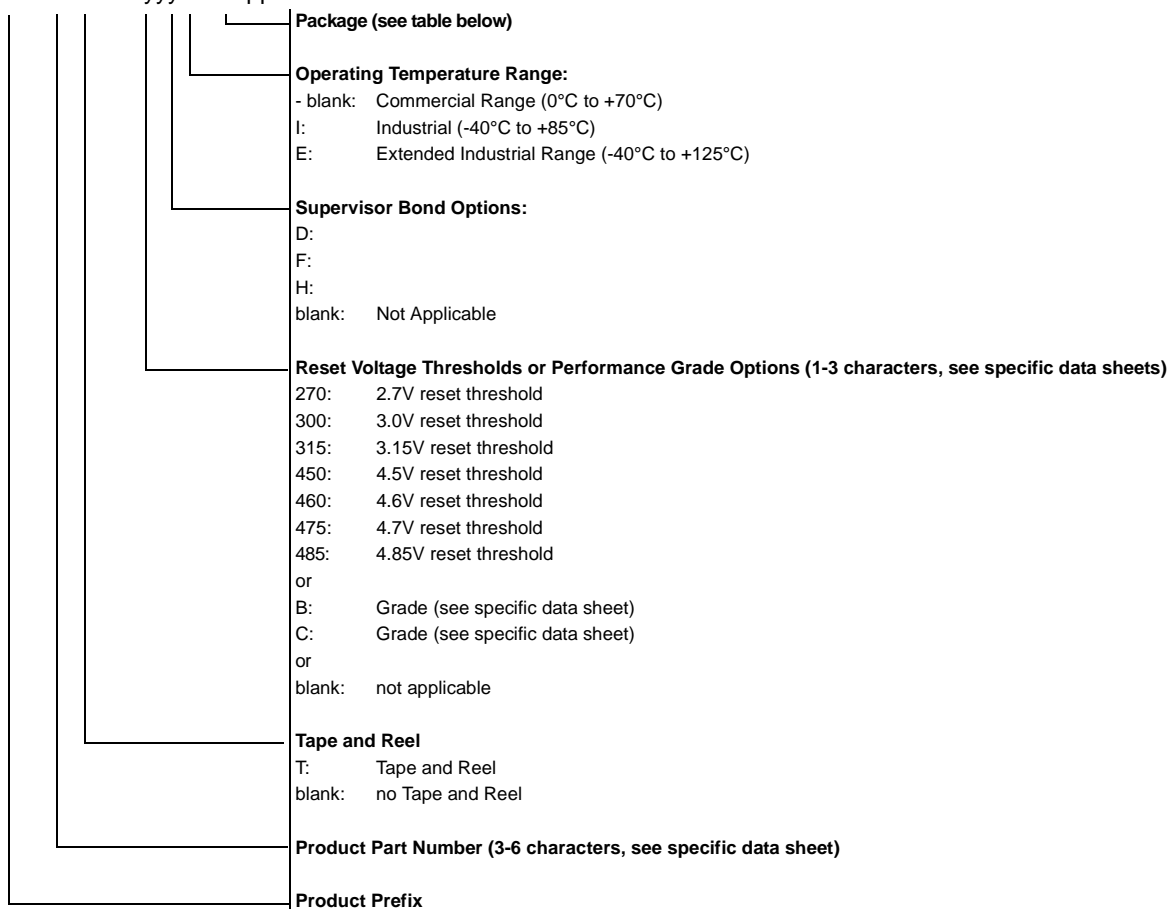

Product Information System

Package	Description	# of Pins	Tube/Bag Qty.	Reel Qty.
TO	TO-92	3	1000	n/a
TT	SOT-23	3	n/a	3000
OT	SOT-23	5	n/a	3000
P	PDIP	8	60	n/a
SN	SOIC	8	100	3300
ST	TSSOP	8	100	2500
MS	MSOP	8	100	2500
MF	DFN (2x3)	8	n/a	3300
MF	DFN (3x3)	8	50	3300
MF	DFN (3x3, 10-Pin)	10	120	3300
ST	TSSOP	14	96	2500
P	PDIP	14	30	n/a
SL	SOIC	14	57	2600
P	PDIP	18	25	n/a
SO	SOIC	18	42	1100
ST	TSSOP	20	74	2500
SS	SSOP	20	67	1600
ML	QFN (6x6)	28	50	1600
ML	QFN (4x4)	16	91	3300

<b>Base Quantities</b>			
<b>Pin Count</b>	<b>Package</b>	<b>T/R</b>	<b>Tube</b>
5	SOT-23	3000	
6	SOT-23	3000	100
8	DFN (2x3)	3300	60
8	DFN (6x5)	3300	60
8	MSOP	2500	100
8	PDIP	1000	60
8	SOIC	3300	100
8	SOIJ	2100	90
8	TSSOP	2500	100
14	PDIP		30
14	SOIC	2600	57
14	TSSOP	2500	96
16	QFN	3300	91
18	PDIP		25
18	SOIC	1100	42
20	PDIP		22
20	QFN	3000	92
20	SOIC	1600	38
20	SSOP	1600	67
28	PDIP		15
28	QFN	1600	61
28	QFN-S	1600	61
28	SOIC	1600	27
28	SPDIP		15
28	SSOP	2100	47
40	PDIP		10
44	MQFP	900	
44	PLCC	500	27
44	QFN	1600	45
44	TQFP	1200	45
64	TQFP	1200	
68	PLCC	300	19
80	TQFP	1200	100
84	PLCC	300	16
100	TQFP		

## ABBREVIATIONS

ADC	Analog-to-Digital Converter
ASK	Amplitude Shift Key
AUSART	Addressable USART (RS-232, RS-485)
BOR	Brown-Out Detection/Reset
CAN	Controller Area Network
CAP	Capture
CCP	Capture/Compare/1 PWM output
CRC	Cyclic Redundancy Check
DAC	Digital-to-Analog Converter
DMA	Direct Memory Access
3 $\phi$	3 Phase PWMs
4 $\phi$	4 Phase PWMs
E2	EEPROM (Reprogrammable)
ECAN	Enhanced Controller Area Network
ECCP	Enhanced Capture/Compare/4 PWM outputs with program dead time
EMA	External Memory Addressing
EUSART	Enhanced USART (RS232, RS485, LIN)
Flash	Reprogrammable memory that holds contents without power
FSK	Frequency Shift Key
I <sup>2</sup> C™	Inter-integrated Circuit Bus
ICSP™	In-Circuit Serial Programming™
ICD	# of In-Circuit Debug Breakpoints
IntOSC	Internal Oscillator
JTAG	Joint Test Action Group
LNA	Low Noise Amplifier
LVD	Low Voltage Detection
LIN XCVR	Local Interconnection Network Transceiver
MI <sup>2</sup> C/SPI	Master I <sup>2</sup> C/SPI
nW	nanoWatt
OTP	One-Time Programmable
PBOR	Programmable Brown-Out Detection/Reset
PLVD	Programmable Low-Voltage Detection
PMP	Parallel Master Port
PSMC	Programmable Switch Mode Controller
PSP	Parallel Slave Port
PSMC	Programmable Switch Mode Controller
PWM	Pulse Width Modulator
ROM-less	External ROM necessary
RSSI	Received Signal Strength Indicator
RTCC	Real Time Clock with Calendar
SLAC	Slope A/D Converter, up to 16 bits
SMB	System Management Bus
SPI	Serial Peripheral Interface
ULPW	Ultra Low Power Wake-up
USART	Universal Synchronous/Asynchronous Receiver/Transmitter
USB	Universal Serial Bus
VREF	Voltage Reference
WDT	Watchdog Timer
WUR	Wake-up Reset
✓P	Programmable
x12	12-bit Instruction Width
x14	14-bit Instruction Width
x16	16-bit Instruction Width

**NOTES:**

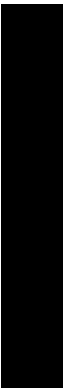



**NOTES:**



**NOTES:**



# Microchip Technology's Quality Policy

**In order to meet or exceed customer expectations at a reduced cost, we encourage our employees to support continuous improvement, anticipate problems and implement root cause solutions.**

## **Aggregate Approach**

Microchip has instituted an "aggregate" approach to understand, align, integrate and unite all company resources. Microchip consciously designed the enterprise as an aggregate system in which company culture, systems, practices, policies and employees work in unison to achieve Microchip's mission and goals. This aggregate system and culture is taught in the Microchip Culture class required for all new hires and taught by Executive Staff members.

The Quality Culture of Microchip is that every organization, business unit and individual owns the quality of their output, whether it is product, process, software or service.

A company must aggressively pursue continuous improvement, employee development, team deployment and statistical techniques to successfully achieve individual accountability of quality.

## **Continuous Improvement**

Microchip promotes a culture of continuous improvement. As stated above, each employee is measured on how they contribute to improvement. Continuous improvement teams are constantly looking to solve problems, allowing us to maximize our value to our customers.

## **Employee Development and Team Deployment**

Every employee has access to a full suite of training. Each employee is measured on Quality and Quantity of work, Teamwork, Continuous Improvement and Customer Satisfaction. Supervisors are measured on how their employees improve and learn. Employees have regular One-on-Ones with their supervisors and an open door is a policy that is really practiced.

## **Statistical Techniques**

Microchip uses statistical process techniques in all aspects of our business. Decision-making, experiment definition and process control are a few areas where these techniques are applied. Every manufacturing employee is trained in SPC before they start their job, since they are the people closest to the product quality.

## **QS-9000 Certification**

Microchip Technology's Quality System is based on QS-9000 requirements. QS-9000 is rapidly becoming the standard Quality System for many industries including Semiconductors. All Microchip product facilities and major subcontractors are QS registered. Development Systems and Mountain View products are designed, manufactured and certified to ISO-9001 requirements.

## **Quality Systems and Reliability Information**

Visit [www.microchip.com](http://www.microchip.com) for detailed Quality Systems and Reliability information.

Microchip's Quality System is fully described in the *Microchip Overview, Quality Systems and Customer Interface Systems Handbook* (DS00169) available on the Microchip web site.

## Support

Microchip is committed to supporting its customers in developing products faster and more efficiently. We maintain a worldwide network of field applications engineers and technical support ready to provide product and system assistance. In addition, the following service areas are available at [www.microchip.com](http://www.microchip.com):

- **Support** link provides a way to get questions answered fast.
- **Sample** link offers free evaluation samples of any Microchip device.
- **Training** link offers webinars, registration for local seminars/workshops and information on annual MASTERS events held throughout the world.

## Sales Office Listing

Technical Support: <http://support.microchip.com>

### AMERICAS

#### Atlanta

Tel: 770-640-0034

#### Boston

Tel: 774-760-0087

#### Chicago

Tel: 630-285-0071

#### Dallas

Tel: 972-818-7423

#### Detroit

Tel: 248-538-2250

#### Kokomo

Tel: 765-864-8360

#### Los Angeles

Tel: 949-462-9523

#### San Jose

Tel: 650-215-1444

#### Toronto

Mississauga, Ontario

Tel: 905-673-0699

### ASIA/PACIFIC

#### Australia - Sydney

Tel: 61-2-9868-6733

#### China - Beijing

Tel: 86-10-8528-2100

#### China - Chengdu

Tel: 86-28-8676-6200

#### China - Fuzhou

Tel: 86-591-8750-3506

#### China - Hong Kong SAR

Tel: 852-2401-1200

#### China - Qingdao

Tel: 86-532-8502-7355

#### China - Shanghai

Tel: 86-21-5407-5533

#### China - Shenyang

Tel: 86-24-2334-2829

#### China - Shenzhen

Tel: 86-755-8203-2660

#### China - Shunde

Tel: 86-757-2839-5507

#### China - Wuhan

Tel: 86-27-5980-5300

#### China - Xian

Tel: 86-29-8833-7250

## Purchase



microchipDIRECT is a web-based purchasing site that gives you 24-hour-a-day

access to all Microchip devices and tools, including pricing, ordering, inventory and support. You can buy the products you need on an easily opened Microchip line of credit.

### ASIA/PACIFIC

#### India - Bangalore

Tel: 91-80-4182-8400

#### India - New Delhi

Tel: 91-11-5160-8631

#### India - Pune

Tel: 91-20-2566-1512

#### Japan - Yokohama

Tel: 81-45-471- 6166

#### Korea - Gumi

Tel: 82-54-473-4301

#### Korea - Seoul

Tel: 82-2-554-7200

#### Malaysia - Penang

Tel: 60-4-646-8870

#### Philippines - Manila

Tel: 63-2-634-9065

#### Singapore

Tel: 65-6334-8870

#### Taiwan - Hsin Chu

Tel: 886-3-572-9526

#### Taiwan - Kaohsiung

Tel: 886-7-536-4818

#### Taiwan - Taipei

Tel: 886-2-2500-6610

#### Thailand - Bangkok

Tel: 66-2-694-1351

### EUROPE

#### Austria - Wels

Tel: 43-7242-2244-399

#### Denmark - Copenhagen

Tel: 45-4450-2828

#### France - Paris

Tel: 33-1-69-53-63-20

#### Germany - Munich

Tel: 49-89-627-144-0

#### Italy - Milan

Tel: 39-0331-742611

#### Netherlands - Druenen

Tel: 31-416-690399

#### Spain - Madrid

Tel: 34-91-708-08-90

#### UK - Wokingham

Tel: 44-118-921-5869

2/16/06



**MICROCHIP**  
[www.microchip.com](http://www.microchip.com)

Microchip Technology Inc. • 2355 W. Chandler Blvd. • Chandler, AZ 85224-6199

**Microcontrollers • Digital Signal Controllers • Analog • Serial EEPROMs**

Information subject to change. The Microchip name and logo, the Microchip logo, Accuron, dsPIC, KEELoq, microID, MPLAB, PIC, PICmicro, PICSTART, PRO MATE, PowerSmart, rfPIC, and SmartShunt are registered trademarks of Microchip Technology Incorporated in the U.S.A. and other countries. AmpLab, FilterLab, Migratable Memory, MXDEV, MXLAB, PICMASTER, SEEVAL, SmartSensor and The Embedded Control Solutions are registered trademarks of Microchip Technology Incorporated in the U.S.A. Analog-for-the-Digital Age, Application Maestro, dsPICDEM, dsPICDEM.net, dsPICworks, ECAN, ECONOMONITOR, FanSense, FlexROM, fuzzyLAB, In-Circuit Serial Programming, ICSP ICEPIC, Linear Active Thermistor, MPASM, Mindi, MIWI, MPLIB, MPLINK, PICkit, PICDEM, PICDEM.net, PICLAB, PICtail, PowerCal, PowerInfo, PowerMate, PowerTool, REAL ICE, rfLab, rfPICDEM, Select Mode, Smart Serial, SmartTel, Total Endurance, UNI/O, WiperLock and ZENA are trademarks of Microchip Technology Incorporated in the U.S.A. and other countries. SQTP is a service mark of Microchip Technology Incorporated in the U.S.A. All other trademarks mentioned herein are property of their respective companies.  
© 2006, Microchip Technology Incorporated. All Rights Reserved. Printed in the U.S.A. 6/06 DS00148L2

